

400

papco®

AUTOMOTIVE AND INDUSTRIAL FASTENERS
ATTACHES AUTOMOBILE ET INDUSTRIEL



Welcome to the
papco® 400 Catalogue
Please click here to begin...

paulin®

H. Paulin & Co. Limited, Toronto, Canada



USING THIS CATALOGUE IS SIMPLE

This catalogue contains an "Index" page which will help you navigate through the catalogue.

You can access the "Index" page any time by clicking on the "PAPCO® Bolt" image at the top of any page. Once there, it's as easy as pointing and clicking at the product name, description or even page number to take you directly to that appropriate page.



You can also use Adobe® Acrobat®'s "Bookmark" tab in the navigation bar at the top of the screen.

To find a part you are looking for, you may either search for a specific part number or name by clicking on the "Search Catalogue" magnifying glass button on the "Index" page, or by clicking on Adobe® Acrobat®'s "Search" under the Edit menu. Enter the part number or word you are searching for and click on the "Find" button. Clicking on the icon again will bring up the same menu – select "Find Next" to find the next instance of the word or phrase you are looking for.



To go to the next page or previous page of the catalogue, click on the appropriate navigation bar icon illustrated here.



papco™ *First In Fasteners*

Since 1920, Papco has been manufacturing and merchandising quality automotive fasteners for original equipment and the aftermarket. Today there are over 12,000 items in the Papco line providing extensive coverage for all types of domestic and import vehicles and fastening applications

The company occupies over 500,000 square feet of space including 5 manufacturing facilities, 9 distribution centers plus its core distribution centre and head office located in Toronto. A leader in fastener and fitting merchandising, Papco provides innovative storage systems for efficient stocking and selling of its many products.



H. Paulin & Co. Limited is ISO 9001:2000 registered and holds the prestigious Ford Q-1 Quality Award.

To better serve our customers, all of our distribution centers are E.D.I. compatible and data such as price lists, catalogues, etc., are available electronically.

Detailed application and specification catalogues for Wheel Parts, Frost Plugs, Body Shop Fasteners, Brass Fittings, etc., are published separately.

Depuis 1920, Papco fabrique et mets en marché des attaches de qualité pour automobiles comme équipement original et pour l'après-marché. Aujourd'hui, il existe plus de 12,000 items Papco qui offrent un très vaste choix de produits pour véhicules domestiques et importés, ainsi que pour toute sorte d'application d'attaches.

La compagnie possède une surface de 500,000 p.c. d'espace qui inclus 5 sites de fabrication, 9 centres de distribution ainsi qu'un noyau central de distribution et bureau-chef situé à Toronto.

Un chef de file dans la mise en marché de pièces et d'attaches, Papco offre un système innovateur d'entreposage pour distribuer et vendre ses nombreux produits.

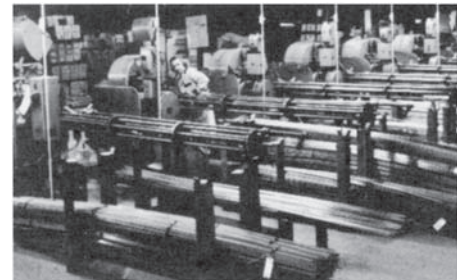

H. Paulin & Cie Limitée est enregistré ISO 9001:2000 et détient le prestigieux Diplôme de Qualité Ford Q-1.

Pour mieux servir nos clients, tous nos centres de distribution sont informatisés et les données tel que listes de prix et catalogues, peuvent être obtenues électroniquement.

Les catalogues d'application détaillée et les spécifications pour Pièces de Roues, Bouchons d'expansion, Attaches pour Carrosserie, Conduit de Laiton, etc., sont publiés séparément.

VANCOUVER – 3179 Thunderbird Cres., Burnaby, B.C. V5A 3G1
Telephone (604) 421-3096 Fax (604) 421-3046

EDMONTON – 11704-180th St., Edmonton, Alta. T5S 1M6
Telephone (780) 450-1346 Fax (780) 463-3597

WINNIPEG – 1832C King Edward St., Winnipeg, Man. R2R 0N1
Telephone (204) 694-3802 Fax (204) 694-3804

MONTREAL – 2590 Debray Street, Laval, QC. H7S 2J4
Telephone (450) 688-4292 Fax (450) 688-4750

MONCTON – 159 Henri Dunant Street, Moncton, NB. E1E 1E4
Telephone (506) 857-8658 Fax (506) 857-9338



paulin™ H. Paulin & Co. Limited, Toronto, Canada M1L 4N3
55 Milne Avenue, Telephone (416) 694-3351 Fax (416) 694-1869
E-mail: paulin@hpaulin.com



INDEX



| | | | |
|---|---|--|---|
| <p>ANCHORS, Lag Bolt 39 Tapcon, Concrete 78 Sleeve 79 Wedge 79</p> <p>ANGLES, Slotted & Solid .. 50-51</p> <p>ASSORTMENTS, Garage 2-3 Utility 4-5 Master 6-8 Super Service 9</p> <p>AXLE SPINDLE NUTS 155</p> <p>BALL JOINTS, Throttle Rod .. 125</p> <p>BINS, Bolt 10-11 Bulk Fastener 13 Service 13</p> <p>BITS, Drill 176-177 6-Lobe 77 Magnetic 72-73 Power Driver 70-71 'Tapcon' Concrete 78</p> <p>BLADES Replace Scraper 107</p> <p>BODYSHOP FASTENERS .. 96-109</p> <p>BOLT-N-NUT, Gauge 123</p> <p>BOLTS, Alternator 117 Battery Hold Down 162 Battery Terminal 162 Body 92 Brake Block 132 Bumper Bar 94 Carriage 38 Cylinder Head 116 Elevator 44 Flange 93 Hex 27-32 Lag 39 Licence Plate 95 Metric Hex 24 Moulding 96 Pan, Oil 131 Plow, Grade 5 38 Rim ... see <i>current Wheel Parts Cat.</i> Spring Centre 113 Stainless Steel 164 Starter 116 Stove 62 Torque-to-yield 116 Uni-Bolts 49 Wheel (Hub) 149-154</p> <p>BRACKETS, Tail Pipe (Muffler) ... 114</p> <p>BRAKE LINES 169</p> <p>BUSHINGS, Door Hinge 111 Machinery 59</p> <p>CABINETS, Bolt-n-Nut 12 Stax-Four 9 Stax-Six 6 Tilt-Bin 13</p> <p>CABLE TIES 157</p> <p>CALIPER, Precision 123</p> <p>CAP SCREWS, Bulk 28 Grade 2 and 5 27 Grade 5 Plated 28 Grade 8 Plated 30 Metric 24 Papcolloy 32 Socket Head 40 Stainless Steel 164</p> <p>CAPS, Dust, Wheel Hubs 155 Power Steering 92 Hole Plug 107, 136 Vacuum 167 Wheel Nut, Plastic 152</p> <p>CLAMPS, Battery Booster 161 Battery, Hold Down 162 Hose 138-139 Muffler 114 Nylon Cable 146</p> <p>CLIPS, Battery, Test 159 Glass Shop 98-99 Hitch Pin 46 Hood Prop 103 Moulding 97 Throttle Rod 125 Trim Fastener 100-102 Tubular Speed Nut 87</p> <p>CONTROLS, Push-Pull ... 140-141</p> <p>DIES and TAPS 174</p> | <p>DRAIN COCKS 117</p> <p>DRILLS and TAPS 174-175</p> <p>DRILL BITS 176-177</p> <p>EXPANSION PLUGS 118-122</p> <p>EXTRACTORS, Screw 175</p> <p>FASTENERS, Body Shop ... 96-109 Canvas 147-148 Exhaust System 115, 132 Glass Shop 98-99 Marine 163-164 Metric 21-26 Moulding 96-97 Palnut 89-90 Papcolloy 32 Pic-a-Pac 172-173 Pushnut 90 Snap 147 Stainless Steel 164 Trim 96-109 Truck and Trailer 75-76 Turn 147 Weatherstrip 102</p> <p>FAUCET, Drum 117</p> <p>FITTINGS, Brake Line 170 Drain Cock 117 Grease 171</p> <p>FLAT STEEL 50-51</p> <p>FROST PLUGS 118-121</p> <p>FUEL LINES 170</p> <p>GASKETS, Drain Plug 129</p> <p>GAUGES, Bolt-n-Nut 123 Screw Thread Pitch 175 Thickness (Feeler) 123</p> <p>GROMMETS, Anchor ... 102-103 Brass 148 PCV Valve 124 Wire 158</p> <p>GUIDES, Window channel ... 99</p> <p>HANDY-PAKS 14-23</p> <p>HOLD-DOWNS, Battery 162</p> <p>HOLDERS, Fuse 158</p> <p>HOOKS, Storage Organizer ... 146</p> <p>INSERTS, Perma-Thread .. 165-166 Sert-a-Nut 83</p> <p>KEYS, Axle 136-137 Socket Screw 23, 41 Woodruff 134</p> <p>KITS, Choke Conversion 141 Drill Bit 177 Expansion Plug 120 Grommet, Brass 148 Nutsetter 72 'O' Ring Assortment 135 Perma-Thread 165-166 Pocket Screwdriver 71 Power Driver Bit 70 Sert-a-Nut 83 Snap Ring Pliers 128 Socket Key 41-42 Speedometer Cable 141 Storage Organizer 146 Uni-Bolt 49 Wheel Parts 152</p> <p>LEADS, Test 159</p> <p>LINES, Brake Line 169 Fuel 170</p> <p>MAGNETS 148</p> <p>MECHANICS' WIRE 136</p> <p>MEGA-PAKS 20, 154</p> <p>METAL, Expanded 51 Flat 50-51</p> <p>METAL CENTRE PLUS 51</p> <p>NUTS, A-Frame Clip 93 Acorn (Cap) 36 Air Cleaner Wing 124 All-Nylon 37 Anchor Grommet 102-103 Axle Spindle 155 Battery Terminal 162 Blind Well 83 Brass 115 Castellated 31 Coupling 49 Double Thick 36, 113 Engine Stud 115</p> | <p>NUTS (cont'd.) Finished Hex 31 Finished Flange 28, 31 Finished Grade 8 30 Flange 34, 93 Heavy 31 Jack, Mirror Mounting 83 Keys, Locks 37 Licence Plate 95 Machine Screw 63 Metric 25 Mirror Mounting, Jack 83 Nylon Insert Lock 35 Nylon Insert Double .. 37, 113 Pal, Lock 89 Pal, Self-Threading 89 Panel 35 Papcolloy 32 Pozi-Lok 35 Pushnuts 90 Rim ... see <i>current Wheel Parts Cat.</i> Sert-a-Nuts 83 Speed 84, 88 Stainless Steel 164 Slotted, Thick 31 Stover, Lock 33, 34 Tensilock (Flange) 34 'U' Nuts 91 Uni-Nuts 37 Wheel (Hub) 149, 152 Wing 36</p> <p>NUTSETTERS, Magnetic 72</p> <p>'O' RINGS 135</p> <p>PERMA-THREAD, Inserts ... 165-166</p> <p>PIC-A-PAC FASTENERS ... 172-173</p> <p>PINS, Clevis 45-46 Cotter 47-48 Door Hinge 111 Hitch 43 Lynch 43 Metric 23, 25 Slotted Spring 133 Taper 137 Weld 84 Wire Lock 43</p> <p>PLIERS, Snap Ring 128</p> <p>PLUGS, Button Hole ... 107, 136 'Duo-Drain' Oil 129 E-Z Seal Oil Drain 122 E-Z Seal Expansion 122 Expansion (Frost) 118-121 Hole (Button) 107, 136 Marine, Drain 164 Oil Drain 130 Pipe 132</p> <p>PROTECTORS, Battery Term. 160</p> <p>PULLERS, Battery Term./Gear ... 159</p> <p>RETAINERS, Bolt 90 Plastic Shield 101 Screw-in 104 Throttle Rod 125</p> <p>RINGS, Snap 126-128 Universal 'O' 135</p> <p>RIVETS, Blind 80-81 Panel, Aluminum 75 Plastic 82, 104 Multi-Grip 81 Window Regulator 97</p> <p>RODS, Fully Thread, Uni-Rod ... 49 Round, Steel 50 Stainless Steel, Threaded ... 164</p> <p>SCISSORS, Utility 107</p> <p>SCRAPERS, Utility 107</p> <p>SCREWS, Brake Bleeder 170 6-Lobe Trim 77 Brass Machine ... see <i>separate cat.</i> Brass Wood ... see <i>separate cat.</i> Cap ... 24, 27, 28, 30, 32, 40, 163 Drill-X, Self-Drilling 76 Floorboard 75-76 Headlamp Adjusting ... 105-106 Lag 39 Machine 25, 63-65 Roofing/Siding 44 Sheet Metal 67-69</p> | <p>SCREWS (cont'd.) Spee-Drill 73 Socket Cap 40 Socket Set 40 Square Head Set 39 Stainless Steel 164 'Tapcon' 78 Tapping 67-69 Trim 73-75 Thread Cutting 67 Truck and Trailer 75-76 Wood, Plated Steel 66</p> <p>SCREWDRIVERS, 6-Lobe Bull Dog 77 'Loxon' Square Drive 72 Magnetic, 6 in 1 73 Magnetic, 6-Lobe 73 Pocket Kit 71</p> <p>SERT-A-NUTS 83</p> <p>SHEARS, Utility 107</p> <p>SHIELDS, Lag Bolt 39</p> <p>SHIMS, Body 111 Caster and Camber ... 110-111</p> <p>SHIMSTOCK, Brass 145 Steel 145</p> <p>SNAP RINGS 126-128</p> <p>SPRINGS, Carburetor 142 Pedal Return 142 Utility 143</p> <p>STABILIZERS, Coil Spring 112</p> <p>STEEL, Angle, Iron 50-51 Flats 50 Round Rods 50 Sheets 51 Tubular 50</p> <p>STUDS, Engine 115 Rear Wheel ... see <i>Wheel Parts Cat.</i></p> <p>TAPS and DIES 174-175</p> <p>TERMINALS, Battery 160 Wiring 156</p> <p>TESTERS, Anti-Freeze 123 Battery 161 Circuit 158</p> <p>THREADED RODS 49, 164</p> <p>THROTTLE BALL JOINTS 125</p> <p>TIES, Cable 157</p> <p>TUBING, Brake Line 169 Copper 171 Round 50 Shrink 158 Square 50 Steel 171</p> <p>TOOLS, Circuit Testers 158 Crimping 157 Fuse Puller 158 Hose Clamp 138 Magnetic Retriever 148 Magnetizer/Demagnetizer ... 148 Riveting 81 Screwdrivers ... 71, 72, 73, 77 Snap Ring 128 Terminal/Gear Puller 159 Terminal/Post Cleaner 161</p> <p>VACUUM CONNECTORS 167</p> <p>WASHERS, Brass 60 Brass, Finishing 61 Copper 60 Fender 58 Fibre 58 Hardened Steel (Papcolloy) ... 32 Lock 55 Machinery 59 Metric 25 Papcolloy 32, 33, 55 Plain Steel 53 Rapid Repair 59 Rivet 80 S.A.E. Steel 54 Spacer 61 Tension 61 Tooth Lock 57 Stainless Steel 163</p> <p>WHEEL PARTS 149-152</p> <p>WIRE, Mechanics' 136</p> <p>YOKES, Clevis 45</p> |
|---|---|--|---|

papco GARAGE ASSORTMENTS



papco Garage Assortments are available in transparent plastic containers. You can see your stock of small fasteners—it is kept neat and handy. Your work bench is clear—yet the right fastener is available when you need it.

★ **THREE COMPARTMENTS**





























★ **CLEAR PLASTIC**

- Contains popular items used in every garage every day.
- Contents are Bright Plated.
- Quantity of each item is based on popularity.
- Each assortment contains only listed items—no "odds and ends".
- Refills of individual items available from standard stock.
- You get a wide range of sizes for any repair job for a minimum investment.
- Three Plastic Compartments — speed up selection.





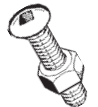





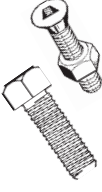

















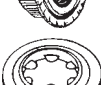

























BRIGHT PLATED

GARAGE ASSORTMENTS

| | | |
|---|---|---|
|  <p>MACHINE SCREWS NO. 020-010 Round Head – Square Drive. Contains 130 Screws, 45 Nuts. 6-32 x 1/4, 3/8, 1/2, 3/4, 1", 1-1/2; Nuts 8-32 x 1/4, 3/8, 1/2, 3/4, 1", 1-1/2; Nuts 10-32 x 1/4, 3/8, 1/2, 3/4, 1", 1-1/2; Nuts Refer to page 63.</p> |  <p>THROTTLE ROD CLIPS AND RETAINERS NO. 020-022 Contains 104 pieces. 262-008, 009, 010, 011, 014, 015, 054, 056, 060, 062, 064, 073, 075, 076, 078. 262-203, 205, 206, 208. Refer to page 125.</p> |  <p>COTTER PINS NO. 020-033 Contains 340 Cotter Pins. 1/16 x 3/4, 1", 3/32 x 1", 1-1/2; 1/8 x 1", 1-1/2; 5/32 x 2". Refer to page 47.</p> |
|  <p>MACHINE SCREWS NO. 020-011 Flat Head – Square Drive. Contains 130 Screws, 45 Nuts Sizes same as listed for 020-011</p> |  <p>TAPPING SCREWS NO. 020-023 Oval Head, Phillips. Contains 100 Screws. 6 x 1, 1-1/4 - Oval Regular 8 x 3/4, 1", 1-1/4, 1-3/8, 1-1/2, 1-3/4 10 x 1 - Oval Small. Refer to page 74.</p> |  <p>TOOTH LOCK WASHERS NO. 020-034 Internal Type Plated. Contains 225 Washers. 3/16 x 1/4, 5/16, 3/8, 7/16 and 1/2. Refer to page 57.</p> |
|  <p>MACHINE SCREWS NO. 020-012 Round Head – Phillips. Contains 100 Screws, 50 Nuts 6-32 x 3/8, 1/2, 3/4; Nuts 8-32 x 3/8, 1/2, 3/4; Nuts 10-32 x 3/8, 1/2, 3/4; Nuts Refer to page 65.</p> |  <p>TAPPING SCREWS NO. 020-024 Hexagon Head. Contains 100 Screws. 8 x 1/2; 10 x 3/8, 1/2, 5/8, 3/4; 14 x 1/2, 5/8, 3/4, 1", 1-1/4; 5/16 x 1". Refer to page 68.</p> |  <p>TOOTH LOCK WASHERS NO. 020-035 External Type Plated. Contains 225 Washers. Size same as listed for 020-034.</p> |
|  <p>SPEED NUTS NO. 020-015 Flat Type. Contains 160 Nuts. 240-089, 091, 100, 101, 120, 158, 108, 127. Refer to page 84.</p> |  <p>TAPPING SCREWS NO. 020-026 Pan Head Slot. 4 x 1/2; 6 x 1/2, 3/4, 1"; 8 x 1/2, 3/4, 1", 1-1/4; 10 x 5/8, 3/4, 1", 1-1/4; 12 x 3/4, 1"; 14 x 3/4, 1". Refer to page 68.</p> |  <p>INCH & METRIC DRAIN PLUGS NO. 020-038 Hexagon Head. Contains 9 Inch and Metric Drain Plugs. 4 of 1/2-20 STD., 3 of 12mm x 1.75, 2 of 14mm x 1.5. Refer to page 129.</p> |
|  <p>SPEED NUTS NO. 020-016 Formed Type. Contains 65 Nuts. 240-226, 228, 232, 242, 243, 247, 250, 267. Refer to page 85.</p> |  <p>METRIC TRIM SCREWS NO. 020-027 Pan, Oval — Phillips Trim. Contains 100 Screws. 230-203, 205, 207; 230-302, 304, 305. Refer to page 74.</p> |  <p>SNAP RINGS EXTERNAL NO. 020-040 Contains 60 Snap Rings. 8 Sizes of 268-500 Series. for 1/8" to 1/2" dia. shafts. Refer to page 126.</p> |
|  <p>SPEED NUTS NO. 020-017 Push-on Type. Contains 160 Nuts 240-320, 325, 331, 335, 355, 365, 370. Refer to page 86.</p> |  <p>HOLE PLUGS NO. 020-028 Contains 47 Plugs. 314-018, 020, 022, 024, 026, 030, 034. Refer to page 136.</p> |  <p>SNAP RINGS EXTERNAL NO. 020-041 Contains 50 External Rings. 6 Sizes of 268-600 Series. for 5/32" to 9/16" dia. shafts. Refer to page 128.</p> |
|  <p>SPEED NUTS NO. 020-018 Tubular Type. Contains 70 Nuts. 240-430, 431, 432, 469, 471, 472. Refer to page 87.</p> |  <p>FINISHING WASHERS 020-030 Standard and Flush Types. Contains 200 Washers. 162-971, 973, 975, 977, 979, 988, 990, 994. Refer to page 61.</p> |  <p>SNAP RINGS INTERNAL NO. 020-042 Contains 50 Internal Rings. 10 Sizes of 268-200 Series for 1/2" to 2" housing dia. Refer to page 128.</p> |
|  <p>WOODRUFF KEYS NO. 020-020 Contains 100 Keys. 302-020, 030, 040, 050, 060, 080, 100, 110, 130, 150, 190, 200. Refer to page 134.</p> |  <p>S.A.E. WASHERS 020-031 Small sizes. Contains 400 Washers. No. 2, No. 4, No. 6, No. 8, No. 10, 1/4. Refer to page 54.</p> |  <p>SQUARE HEAD PIPE PLUGS NO. 020-043 Contains 20 Plugs. 260-901, 902 and 903. Refer to page 132.</p> |
|  <p>WOODRUFF KEYS NO. 020-021 Contains 29 Large Keys. 302-190, 200, 210, 214, 215, 220, 240, 250, 257, 270, 280, 290, 291, 292. Refer to page 134.</p> |  <p>OVERSIZE DRAIN PLUGS NO. 020-032 Contains 7 Plugs with gaskets. 263-711, 712, 713. Refer to page 129.</p> |  <p>STOVE BOLTS NO. 020-044 Round Head, Square Drive. Contains 68 Bolts and Nuts. 3/16 x 1/2, 3/4, 1", 1-1/4, 1-1/2, 2", 1/4 x 1/2, 3/4, 1", 1-1/4, 1-1/2, 2". Refer to page 62.</p> |



paperco GARAGE ASSORTMENTS

| | | | | | |
|---|--|--|--|---|---|
|  | STOVE BOLTS NO. 020-045 Flat Head, Square Drive. Contains 68 Bolts and Nuts. Sizes same as listed for 020-044. |  | UNI-NUT LOCK NUTS NO. 020-066 Contains 45 Nuts. No. 4, No. 6, No. 8, No. 10, No. 14 (1/4), 5/16, 3/8. Refer to page 37. |  | LIFT-THE-DOT® FASTENERS NO. 020-092 Contains 20 Fasteners. 400-900, 902, 903, 904, 913. Refer to page 147. |
|  | SQUARE HEAD SET SCREWS NO. 020-046 Contains 35 Screws. 1/4 x 1/2, 3/4, 5/16 x 1/2, 3/4 ; 3/8 x 1/2, 3/4, 1" ; 7/16 x 1", 1/2 x 1", 2". Refer to page 39. |  | WIRING TERMINALS NO. 020-067 Contains 45 Terminals. 569-422, 425, 426, 432, 461, 462, 464, 466, 467, 473, 500, 512, 516, 522, 531. Refer to page 157. |  | TURN FASTENERS NO. 020-093 Contains 20 Fasteners. 400-901, 905, 910, 911, 912. Refer to page 147. |
|  | LOCK WASHERS NO. 020-047 Contains 235 Washers. 3/16, 1/4, 5/16, 3/8, 7/16, and 1/2. Refer to page 56. |  | 6-LOBE TRIM SCREWS NO. 020-070 Oval Head. Contains 70 Screws. 231-205, 206, 209, 210, 213, 219. Refer to page 77. |  | HOSE CLAMPS NO. 020-096 Contains 28 Fuel Injection Hose Clamps. 1/4, 5/16, 3/8. Refer to page 139. |
|  | EXPANSION PLUGS NO. 020-048 Contains 50 Plugs. 260-008, 010, 014, 018, 020, 024, 026, 028, 030, 034, 036, 039, 045, 054, 057, 069, 130, 144. Refer to page 121. |  | 6-LOBE TRIM SCREWS NO. 020-071 Pan Head. Contains 70 Screws. 231-251, 252, 257, 264. Refer to page 77. |  | HOSE CLAMPS NO. 020-097 Contains 60 Constant Tension Hose Clamps. 3/8, 7/16, 1/2, 5/8, 3/4, 1". Refer to page 139. |
|  | TAPER PINS NO. 020-050 Contains 46 Taper Pins. 00 x 1", 1-1/2 ; 0 x 1", 1-1/2 ; 1 x 1", 1-1/2, 2" 2 x 1-1/4, 1-1/2, 2" ; 3 x 1-1/4, 1-1/2, 2" 4 x 2", 2-1/2 ; 5 x 1-1/2, 2", 2-1/2. Refer to page 137. |  | O-RINGS NO. 020-072 Contains 78 Rings. 15 sizes from 1/8" to 3/4" I.D. Refer to page 135. |  | METRIC CAP SCREWS NO. 020-125 I.S.O. Coarse Thread. Contains 82 Screws. M4 x 16 ; M5 x 16, 20, 25 ; M6 x 16, 25, 35. Refer to page 26. |
|  | TAPER PINS NO. 020-051 Contains 36 Large size. 4 x 1-1/2, 2", 2-1/2 ; 5 x 1-1/2, 2", 2-1/2 ; 6 x 2", 2-1/2, 3" ; 7 x 3". Refer to page 137. |  | HITCH PIN CLIPS NO. 020-073 Contains 40 Clips. 255-303, 310, 316, 321, 325, 326. Refer to page 46. |  | METRIC CAP SCREWS NO. 020-126 I.S.O. Coarse Thread. Contains 25 Screws. M8 x 16, 20, 25, 35 ; M10 x 30, 40, 50. Refer to page 26. |
|  | PALNUTS NO. 020-052 Self-Threading. Contains 100 Nuts. 9 sizes for 1/8" to 5/16" dia. studs in both regular and sealer types. Refer to page 89. |  | PALNUT LOCK NUTS NO. 020-074 Regular and Washer Types — Inch. Contains 100 Nuts. 242-016, 018, 020, 022. 242-108, 110, 114, 116. Refer to page 89. |  | METRIC HEX NUTS NO. 020-127 I.S.O. Coarse Thread. Contains 110 Nuts. M4, M5, M6, M8, M10, M12. Refer to page 26. |
|  | TENSILOCK FLANGE NUTS NO. 020-053 Contains 50 Nuts. 118-014, 016, 018, 020 and 022. Refer to page 34. |  | PALNUT LOCK NUTS NO. 020-075 Regular and Washer Types — Metric. Contains 100 Nuts. 243-004, 005, 105, 106. Refer to page 89. |  | METRIC LOCK NUTS NO. 020-128 Nylon Collar — Pozzi-Lok. Contains 33 Nuts. M4, M5, M6, M8, M10. Refer to page 26. |
|  | NYLON DRAIN PLUG GASKETS NO. 020-054 Contains 60 Gaskets. 263-816, 817, 818, 820, 824 and 828. Refer to page 129. |  | BOLT RETAINERS NO. 020-076 Inch sizes. Contains 100 Retainers. 242-314, 316, 318, 320, 322. Refer to page 90. |  | METRIC FLAT WASHERS NO. 020-129 Contains 235 Washers. 4mm, 5mm, 6mm, 8mm, 10mm. Refer to page 26. |
|  | KEEPS LOCK NUTS NO. 020-055 Contains 75 Nuts. 119-006, 008, 010, 011, 014, 015, 016 and 018. Refer to page 37. |  | BOLT RETAINERS NO. 020-077 Metric Sizes. Contains 100 Retainers. 243-306, 308, 310, 312. Refer to page 90. |  | METRIC LOCK WASHERS NO. 020-130 Contains 300 Washers. 4mm, 5mm, 6mm, 8mm, 10mm. Refer to page 26. |
|  | BRASS WASHERS NO. 020-056 Contains 100 Washers. 162-810, 812, 814, 816, 818, 820 and 822. Refer to page 60. |  | 'U' NUTS NO. 020-078 Multi-Thread. Contains 65 Nuts. 240-614, 616, 617, 618. Refer to page 91. |  | METRIC SPRING WASHERS NO. 020-131 Contains 250 Washers. 4mm, 5mm, 6mm, 8mm, 10mm. Refer to page 26. |
|  | FENDER WASHERS NO. 020-057 Contains 71 Washers. 1/4 x 1-1/4 ; 5/16 x 1", 1-1/4 ; 3/8 x 1-1/2. Refer to page 58. |  | 'U' NUTS NO. 020-079 Multi-Thread — Metric. Contains 50 Nuts. 241-604, 605, 606, 607, 608, 609, 610. Refer to page 91. |  | METRIC SOCKET SET SCREWS NO. 020-132 Contains 29 Screws. M4 x 5, 10 ; M5 x 10, 15 ; M6 x 8, 12, 20 ; M8 x 8, 12, 20. Refer to page 26. |
|  | STEEL SPACER WASHERS NO. 020-058 Contains 125 Washers. 1/4, 5/16, 3/8, 7/16, 1/2, 9/16, 5/8, 3/4, 7/8, 1", 1-1/8, 1-1/4, 1-3/8 and 1-1/2. Refer to page 61. |  | 'U' NUTS NO. 020-080 Single-Thread. Contains 65 Nuts. 240-708, 709, 710, 714, 715. Refer to page 91. |  | METRIC MACHINE SCREWS NO. 020-133 Contains 210 Screws and Nuts. M4 x 6, 12 — Nuts M5 x 10, 16 — Nuts M6 x 10, 16, 20 — Nuts Refer to page 26. |
|  | FIBRE WASHERS NO. 020-059 Contains 130 Washers. 1/32" Thick — 162-203, 206, 209, 211, 212, 214, 215, 210, 221. 1/16" Thick — 162-256, 259, 261, 262. Refer to page 58. |  | BLIND WELL NUTS NO. 020-081 Contains 20 Nuts. 6-32, 8-32, 10-32, 1/4-20. Refer to page 83. |  | METRIC COTTER PINS NO. 020-134 Contains 275 Pins. 1.5 x 16 ; 2 x 20 ; 3 x 25, 40 ; 4 x 50. Refer to page 26. |
|  | UNIVERSAL CLEVIS PINS NO. 020-061 Contains 15 Pins. 255-044, 054, 064. Refer to page 45. |  | COPPER WASHERS NO. 020-083 Contains 100 Washers. 162-860, 864, 866, 868, 870, 872. Refer to page 60. |  | METRIC SPRING PINS NO. 020-135 Contains 64 Pins. 2 x 16 ; 2.5 x 18 ; 3 x 40 ; 4 x 18, 36 ; 5 x 36, 50 ; 6 x 50. Refer to page 26. |
|  | CLEVIS PINS NO. 020-062 Contains 41 Pins. 255-225, 226, 228, 230, 231, 235, 236, 237, 238, 241, 242, 244, 246, 251. Refer to page 46. |  | PUSHNUT FASTENERS NO. 020-084 Contains 100 Fasteners. 242-406, 408, 410, 414, 416, 418, 422 ; 243-404, 405. Refer to page 90. |  | TAPPING SCREWS NO. 020-200 Pan Head — Socket Steel. Contains 175 Screws. 6 x 1/2 ; 6 x 5/8 ; 8 x 5/8 ; 8 x 3/4 ; 8 x 1 ; 10 x 1/2 ; 10 x 3/4 ; 10 x 1. Refer to page 68. |
|  | UTILITY SPRINGS NO. 020-063 Compression and Extension Types. Contains 100 Springs Refer to page 144. |  | SOCKET PIPE PLUGS NO. 020-087 Contains 20 Pipe Plugs. 260-921, 922 and 923. Refer to page 132. |  | WOOD SCREWS NO. 020-201 Flat Head — Socket Steel. Contains 160 Screws. 6 x 1/2 ; 6 x 5/8 ; 6 x 3/4 ; 8 x 3/4 ; 8 x 1 ; 8 x 1-1/4 ; 10 x 1 ; 10 x 1-1/4. Refer to page 66. |
|  | POZI-LOCK NUTS NO. 020-064 UNC Coarse Thread. Contains 40 Nuts. 1/4, 5/16, 3/8, 7/16 and 1/2 Refer to page 35. |  | CABLE CLAMPS NO. 020-088 Contains 40 Nylon Clamps. 1/4, 3/8, 1/2, 5/8, 3/4, 1". Refer to page 146. |  | BRASS WOOD SCREWS NO. 020-210 Contains 155 pieces — 8 sizes. 6 x 1/2, 3/4, 1" ; 8 x 3/4, 1" ; 1-1/4, 1-1/2 Flat Socket Head — 6 x 3/4 Round Socket Head. Refer to page 66. |
| | POZI-LOCK NUTS NO. 020-065 UNF Fine Thread. Contains 40 Nuts. 1/4, 5/16, 3/8, 7/16 and 1/2 Refer to page 35. |  | SERT-A-NUTS NO. 020-090 Contains 20 Inserts plus Installation Tools. 6-32, 8-32, 10-24, and 1/4-20. Refer to page 83. | | STAINLESS STEEL FASTENERS NO. 020-212 Contains 110 pieces — 8 sizes. 6 x 3/4 ; 8 x 3/4, 1" ; 10 x 1, 1-1/2 Flat Socket Head — 6 x 3/4 Round Socket Head. No. 6, 8 Finishing Washers. Refer to page 164. |

Note: Contents of assortments subject to change with market



FOR GARAGE AND HARDWARE USE

These practical assortments enable every garage and repair shop to carry a useful stock of these popular fastener.

- Every size in an individual compartment.
- Sturdy, reinforced fireboard display boxes with plastic trays.
- Wide range of popular items at small cost.
- Refills available from standard stock.
- Suggested retail codes shown in lid.
- Contents bright plated.
- 5-1/2" w. x 11-1/4" l. x 1-1/2" d.

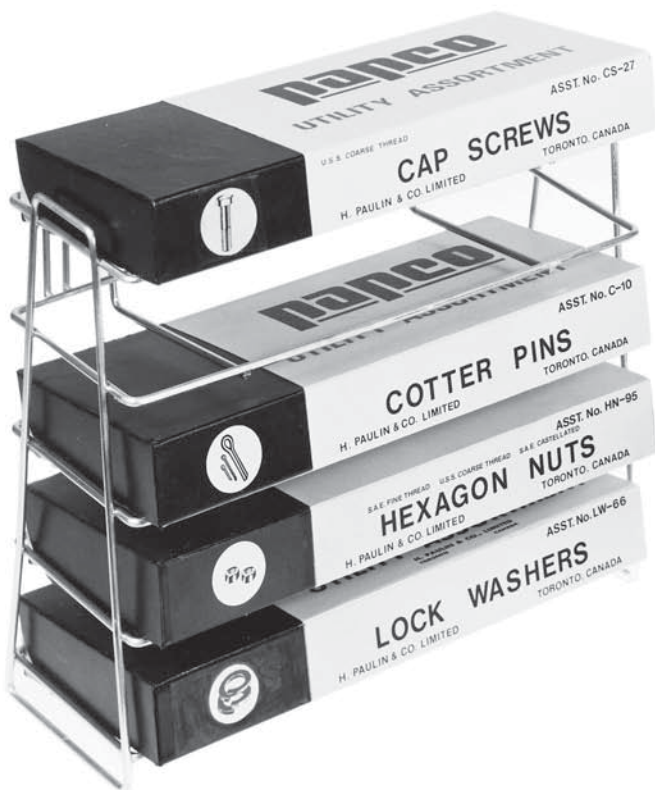



paperco UTILITY ASSORTMENTS

| | | | | | |
|-------------------------------|--|-----------------------|--|----------------------|--|
| | WING NUTS NO. 020-310 Forged Steel. Contains 151 Wing Nuts. 8-31, 10-24, 1/4-20, 5/16-18, 3/8-16. Refer to page 36. | | CAP SCREWS NO. 020-327 U.N.C. Coarse Thread. Contains 105 Screws. Sizes same as listed for 020-326. | | SQUARE HEAD SET SCREW NO. 020-344 Contains 66 Screws. 1/4 x 1/2, 1"; 5/16 x 3/4, 1", 1-1/2; 3/8 x 3/4, 1", 1-1/2; 1/2 x 1", 2". Refer to page 39. |
| | WHEEL NUTS NO. 020-311 Contains 40 Wheel Nuts. 558-014, 016, 027, 044, 047, 100; 559-125, 150. Refer to separate catalogue Refer to page 154. | | SOCKET HEAD CAP SCREWS NO. 020-328 Contains 36 Screws. 1/4 x 3/4, 1", 1-1/2; 5/16 x 3/4, 1", 1-1/2; 3/8 x 1", 1-1/2; 7/16 x 1-1/2; 1/2 x 1-1/2. Refer to page 40. | | HEX NUTS NO. 020-347 U.N.C. and U.N.F. Contains 133 Nuts. 1/4, 5/16, 3/8, 7/16, and 1/2. Refer to page 29. |
| | TAPPING SCREWS NO. 020-312 Pan and Oval Slot. Contains 495 Screws. Pan — 6 x 3/8, 1/2, 3/4, 1"; 8 x 3/8, 1/2, 3/4, 1"; 10 x 1/2, 3/4, 1"; 14 x 1". Oval — 6 x 3/4, 1"; 8 x 3/4, 1"; 10 x 3/4, 1". Refer to page 68. | | CLEVIS PINS NO. 020-329 Universal Type. Contains 24 Pins with Cotter Pins. 255-044, 054, 064, 074, 084, 106. Refer to page 45. | | STOVER® LOCKNUTS NO. 020-348 U.N.F. Fine Thread Contains 90 Nuts. 1/4, 5/16, 3/8, 7/16, and 1/2. Refer to page 34. |
| | COTTER PINS NO. 020-313 Contains 1000 Cotter Pins. 1/16 x 3/4, 1", 1-1/2; 3/32 x 3/4, 1", 1-1/2; 1/8 x 1", 1-1/2, 2"; 5/32 x 1-1/2. Refer to page 47. | | CARRIAGE BOLTS NO. 020-330 Contains 70 Bolts and 70 Nuts. 1/4 x 1", 1-1/2; 5/16 x 1", 1-1/2, 2"; 3/8 x 1", 1-1/2, 2", 3"; 1/2 x 2", 3", 3-1/2; 5/8 x 3", 4". Refer to page 38. | | STOVER® LOCKNUTS NO. 020-349 U.N.C. Coarse Thread Contains 90 Nuts. 1/4, 5/16, 3/8, 7/16, and 1/2. Refer to page 34. |
| | HAMMER-LOCK COTTER PINS NO. 020-314 Contains 800 Pins. 1/16 x 3/4, 1", 1-1/2; 3/32 x 3/4, 1", 1-1/2; 1/8 x 1", 1-1/2, 2"; 5/32 x 1-1/2. Refer to page 48. | | MACHINE SCREWS NO. 021-331 Round Head — Square Drive. Contains 320 Screws and 320 Nuts. 4-40 x 1/2, 3/4 — Nuts. 6-32 x 3/8, 1/2, 3/4, 1" — Nuts. 8-32 x 3/8, 1/2, 3/4, 1", 1-1/2, 2" — Nuts. 10-32 x 1/2, 3/4, 1", 1-1/2 — Nuts. Refer to page 64. | | TENSION WASHERS NO. 020-351 Contains 210 Washers. 3/16, 1/4, 5/16, 3/8, 7/16, and 1/2. Refer to page 61. |
| | SPEED NUTS NO. 020-315 Flat Type. Contains 325 Nuts. 240-090, 091, 097, 100, 101, 107, 120, 121, 127, 160. Refer to page 87. | | SQUARE HEAD PIPE PLUGS NO. 020-332 Contains 42 Plugs. 1/8, 1/4, 3/8, 1/2. Refer to page 132. | | PLAIN STEEL WASHERS NO. 020-352 Contains 379 Washers (5.5 lbs.). 3/16, 1/4, 5/16, 3/8, 7/16, 1/2, 9/16, and 5/8 — Bolt Sizes. Refer to page 53. |
| | SPEED NUTS NO. 020-316 Formed Type. Contains 110 Nuts. 240-210, 220, 227, 243, 246, 247, 248, 249, 263, 268. Refer to page 87. | | MACHINE SCREWS NO. 020-333 Flat Head — Square Drive. Contains 350 Bolts and 350 Nuts. Refer to page 64. | | TAPPING SCREWS NO. 020-353 Pan Head — Socket. Contains 500 Screws. 4 x 1/2; 6 x 3/8, 1/2, 3/4, 1"; 8 x 3/8, 1/2, 3/4, 1", 1-1/4; 10 x 1/2, 5/8, 3/4, 1"; 12 x 3/4; 14 x 1". Refer to page 68. |
| | SPEED NUTS NO. 020-317 Push-on and Tubular. Contains 275 Nuts. 240-320, 325, 340, 350, 355, 365, 370, 375, 410, 415, 430, 431, 440. Refer to page 87. | | SOCKET KEYS NO. 020-335 Contains 52 Keys. 140-102, 103, 104, 107, 108, 109, 110, 111, 112. Refer to page 41. | | WOOD SCREWS NO. 020-354 Flat and Round Head — Socket. Contains 460 Screws. Flat — 4 x 1/2; 5 x 5/8; 6 x 3/4; 8 x 3/4, 1", 1-1/4, 1-1/2; 10 x 1/2. Round — 4 x 1/2; 5 x 5/8; 6 x 3/4; 8 x 1". Refer to page 66. |
| 'E-Z Seal' expansion plugs"/> | 'E-Z SEAL' EXPANSION PLUGS NO. 020-318 Contains 13 Plugs. 263-548, 556, 564, 572, 580, 588, 596, 604, 612, 620, 628, 633, 644. Refer to page 122. | | ACORN (CAP) NUTS NO. 020-336 Zinc Alloy — Nickel Plated. Contains 87 Nuts. 6-32, 8-32, 10-24, 1/4-20, 5/16-18, 3/8-16, 1/2-13. Refer to page 36. | | 6-LOBE TRIM SCREWS NO. 020-355 Oval and Pan Head. Contains 140 Screws. 231-205, 206, 209, 210, 213, 219, 251, 252, 257, 264. Refer to page 77. |
| Spring pins"/> | SPRING PINS NO. 020-319 Contains 116 Pins. 3/32 x 1/2, 1"; 1/8 x 1/2, 1"; 5/32 x 3/4, 1-1/2; 3/16 x 1", 1-1/2; 1/4 x 1", 1-1/2; 5/16 x 1-1/2; 3/8 x 2". Refer to page 133. | Hitch pin clips"/> | HITCH PIN CLIPS NO. 020-338 Contains 105 Clips. 255-303, 306, 307, 308, 310, 311, 316, 320. Refer to page 46. | Brass wood screws"/> | BRASS WOOD SCREWS NO. 020-356 Flat and Round Head — Socket. Contains 380 Screws. 4 x 1/2; 5 x 5/8; 6 x 3/4; 8 x 3/4, 1", 1-1/4, 1-1/2; 10 x 1/2 — Flat Socket. 4 x 1/2; 5 x 5/8; 6 x 3/4; 8 x 1" — Round Socket. Refer to page 66. |
| Socket set screws"/> | SOCKET SET SCREWS NO. 020-321 Contains 120 Screws. Refer to page 42. | Lock washers"/> | LOCK WASHERS NO. 020-339 Contains 505 Washers. 3/16, 1/4, 5/16, 3/8, 7/16, 1/2, 9/16, 5/8, 3/4. Refer to page 56. | 'Plasti-Rivets'"/> | 'PLASTI-RIVETS' NO. 020-357 Contains 130 Rivets. 247-410, 415, 420, 450, 455, 460, 465, 470, 475, 480, 485. Refer to pages 103, 104. |
| Brass cotter pins"/> | BRASS COTTER PINS NO. 020-322 Contains 500 Pins. 3/64 x 3/8; 1/16 x 3/4, 1", 1-1/2; 3/32 x 3/4, 1", 1-1/2; 1/8 x 1", 1-1/2, 2". Refer to page 48. | Tooth lock washers"/> | TOOTH LOCK WASHERS NO. 020-340 Internal and External Types. Contains 900 Washers. No. 6, No. 8, No. 10, 1/4, 5/16, 3/8, 7/16, 1/2. Refer to page 57. | Anchor nuts"/> | ANCHOR NUTS NO. 020-358 Contains 150 Anchor Nuts. Complete coverage. Refer to page 103. |
| Stove bolts"/> | STOVE BOLTS NO. 020-323 Round Head — Longer Lengths. Contains 80 Bolts and 80 Nuts. 3/16 x 1/2, 3/4, 1", 1-1/2; 1/4 x 3/4, 1", 1-1/2, 2". Refer to page 62. | S.A.E. washers"/> | S.A.E. WASHERS NO. 020-341 Contains 370 Washers. 3/16, 1/4, 5/16, 3/8, 7/16, 1/2, 9/16, and 5/8. Refer to page 54. | Metric cap screws"/> | METRIC CAP SCREWS NO. 020-425 Fine Thread Series. Contains 100 Screws and Nuts. Refer to page 26. |
| Stove bolts"/> | STOVE BOLTS NO. 020-324 Round Head — Square Drive. Contains 200 Bolts and 200 Nuts. 3/16 x 1/2, 3/4, 1", 1-1/2; 1/4 x 3/4, 1", 1-1/2, 2". Refer to page 62. | Utility springs"/> | UTILITY SPRINGS NO. 020-342 Extension and Compression. Contains 83 Springs. 311-604, 605, 606, 608, 609, 610, 611, 612, 615, 616, 618, 676, 677, 678, 684. Refer to page 144. | Metric cap screws"/> | METRIC CAP SCREWS NO. 020-426 I.S.O. Coarse Thread. Contains 160 Screws and Nuts. Refer to page 26. |
| Cap screws"/> | CAP SCREWS NO. 020-326 U.N.F. Fine Thread. Contains 105 Screws. 1/4 x 3/4, 1", 1-1/2; 5/16 x 3/4, 1", 1-1/2; 3/8 x 1", 1-1/2; 7/16 x 1-1/2; 1/2 x 1-1/2. Refer to page 29. | Cotter pins"/> | COTTER PINS NO. 020-343 Large sizes. Contains 195 Pins. 5/32 x 2"; 3/16 x 2", 2-1/2; 1/4 x 2", 2-1/2, 3"; 5/16 x 2-1/2, 3"; 3/8 x 3". Refer to page 47. | | |

Note: Contents of assortments subject to change with market

Papco STAX-SIX CABINET



The modern method of stocking Master Assortments. Each steel STAX-SIX Cabinet holds six Master Assortments in its own rigid drawer slide.

No. 022-091



(Assortments or Assortment Drawers NOT included.)

- Heavy gauge steel construction.
- Baked black enamel finish.
- Rigid drawer slide.
- No spill feature.

No. 022-091
 Holds one Master Assortment

- Build as you buy.
- Designed for efficient stacking one on top of another.

NOT ILLUSTRATED

MASTER ASSORTMENTS

| | | |
|--|--|---|
|  <p>COMPRESSION FITTINGS * NO. 020-500 Contains 99 Fittings. 660-3, 660-4, 660-5, 660-6, 661-3, 661-4, 661-5, 661-6, 662-3, 662-4, 662-5, 662-6, 668-2A, 668-3A, 668-4A, 668-5A, 669-2A, 669-3A, 669-4A, 669-5A.</p> <p>FLARE FITTINGS * NO. 020-501 Contains 45 Fittings. 441-3, 441-4, 441-5, 441-6, 442-3, 442-4, 442-5, 442-6, 446-4A, 446-5A, 448-3A, 448-4A, 448-4B, 448-5A, 448-5B, 448-6B, 449-4A, 449-5B, 449-6B.</p> <p>INVERTED FLARE * NO. 020-502 Contains 84 Fittings. 141-3, 141-4, 141-5, 141-6, LS141-3, LS141-4, 142-3, 142-4, 142-5, 142-6, 148-3A, 148-4A, 148-5A, 148-5B, 148-6B, 149-3A, 149-4A, 149-5A, 149-5B, 149-6B.</p> <p>PIPE FITTINGS * NO. 020-503 Contains 71 Fittings. 101-A, 101-B, 103-A, 103-B, 109-A, 109-B, 109-C, 110-BA, 110-CB, 110-DC, 112-A, 112-B, 112-C, 115-A, 115-B, 115-C, 124-A, 124-B, 124-C, TF-8.</p> <p>FUEL LINE FITTINGS * NO. 020-505 Contains 70 Fittings. P1537, P1551, P1555, P1556, P1557, P1560, P1561, P1564, P1565, P1566, P1570, P1571, P1572, P1581, P1582, P1598, 101-C, 307-001, 307-002, 307-008.</p> <p>HOSE BARBS * NO. 020-506 Contains 59 Fittings. 9125-4A, 9125-4B, 9125-5A, 9125-5B, 9125-6B, 9125-6C, 9125-8C, 9125-8D, 9125-10C, 9125-10D, 9125-12D, 9125-12E, 9126-4A, 9126-4B, 9126-6B, 9126-6C, 9126-8D, 9129-4, 9129-6, 9129-8.</p> <p>HYDRAULIC BRAKE FITTINGS * NO. 020-507 Contains 52 Fittings. S141-3, S141-4, S141-5, 142-3, 142-4, 142-5, PC1176, PC1177, PC1190, PC1191, PC1192, 7818, 7828, 7829, 7897, 7908, 7910, 7911, 7912.</p> <p>WOOD SCREWS NO. 020-600 Flat and Round Head — Socket. Contains 850 Screws. 4 x 1/2, 3/4, 5 x 5/8; 6 x 3/4, 1", 1-1/4, 1-1/2; 8 x 3/4, 1", 1-1/4, 1-1/2; 10 x 3/4, 1", 1-1/2 — Flat Socket. 4 x 1/2; 5 x 5/8; 6 x 3/4; 8 x 3/4, 1", 1-1/4; 10 x 1-1/2 — Round Socket. Refer to page 66.</p> <p>BRASS WOOD SCREWS NO. 020-601 Flat and Round Head — Socket. Contains 735 Screws. Sizes same as listed for 020-600</p> |  <p>BRAKE BLEEDER SCREWS NO. 020-604 Contains 63 pcs. 904-200, 201, 203, 204, 206, 209, 212, 213, 218, 219, DS141-3, -4, -5, -6, PC1176, PC1177, PC1178, MA300, MC300. Refer to page 170.</p> <p>VACUUM CONNECTORS NO. 020-605 Contains 138 pcs. 904-901, 902, 920, 922, 923, 924, 932, 939, 941, 960, 965, 975, 976, 990, 991, 992, 339. Refer to page 167.</p> <p>DRAIN COCKS AND FITTINGS NO. 020-606 Contains 119 Fittings. D39B, D40B, D60-3, -4, -5, -6, D61-3, -4, -5, -6, D62-3, -4, -5, -6; 260-902, 903, 904, 951, 952, 953, 957, 958. Refer to page 117.</p> <p>DRAIN PLUG GASKETS NO. 020-607 Contains 210 Gaskets. 263-800, 801, 802, 803, 804, 805, 807, 808, 809, 810, 815, 816, 817, 818, 855, 856, 860, 870, 873, 875. Refer to pages 129, 131.</p> <p>WING NUTS AND HOOD PROPS NO. 020-608 103-010,014, 016, 018; 247-808, 809, 813, 823, 861; 263-314, 316, 324, 325, 326; 700-106, 108. Refer to page 124.</p> <p>CARBURETOR CLIPS NO. 020-609 Contains 293 Clips. 262-008, 009, 010, 011, 014, 015, 054, 056, 062, 064, 073, 075, 076, 078, 080, 084, 088, 268-516. Refer to page 125.</p> <p>TAPER PINS NO. 020-610 Contains 100 Pins. 00 x 1", 1-1/2; 0 x 1", 1-1/2; 1 x 1", 1-1/2, 2" 2 x 1-1/4, 1-1/2, 2"; 3 x 1-1/4, 1-1/2, 2" 4 x 1-1/2, 2", 2-1/2; 5 x 1-1/2, 2", 2-1/2, 3". Refer to page 137.</p> <p>BUMPER BAR BOLTS NO. 020-611 Contains 68 Bolts and 68 Nuts. 245-154, 160, 161, 164, 165, 167, 172, 173, 174, 175, 182, 183, 184, 220, 221; 101-916, 918, 920, 922; 700-008. Refer to page 94.</p> <p>TAPPING SCREWS NO. 020-612 Pan, Oval and Hex — Slot. Contains 937 Screws. Pan — 6 x 3/8, 1/2, 3/4, 1"; 8 x 3/8, 1/2, 3/4, 1"; 10 x 1/2, 3/4, 1"; 14 x 1". Oval — 6 x 3/4, 1"; 10 x 3/4. Hex — 8 x 1/2; 10 x 3/4; 14 x 1". Refer to pages 67, 68, 69.</p> |  <p>TAPPING SCREWS NO. 020-613 Pan, Oval Regular, Oval Small — Phillips. Contains 530 Screws. Pan — 6 x 1/2; 8 x 1/2, 3/4; 10 x 1/2, 3/4, 1-1/2; 10 x 3/4, 1", 1-1/2; 8 x 3/4, 1"; 10 x 5/8, 1". Oval Small — 8 x 1/2, 3/4, 1", 1-1/8, 1-1/4, 1-1/2; 10 x 3/4, 1", 1-1/2; 230-205, 207, 302, 304, 305. Refer to page 74.</p> <p>WOODRUFF KEYS NO. 020-614 Contains 210 Keys. 302-010, 020, 030, 040, 050, 060, 070, 080, 090, 100, 110, 121, 130, 150, 152, 160, 180, 200, 210, 240. Refer to page 134.</p> <p>TAPPING SCREWS NO. 020-615 Hexagon Head — Fender Washers. Contains 280 Screws — 125 Washers. 8 x 1/2; 10 x 3/8, 1/2, 5/8, 3/4; 14 x 1/2, 5/8, 3/4, 1", 1-1/4; 5/16 x 3/4, 1", 1-1/2; 3/8 x 1", 1-1/2; 162-394, 395, 396, 397, 398. Refer to pages 68, 69.</p> <p>MARINE FASTENERS NO. 020-616 Solid Brass — Nickel Plated. Contains 1005 pieces. Wood Screws — Oval Slot. 6 x 3/4; 8 x 3/4, 1", 1-1/4, 1-1/2; 10 x 1-1/4. Machine Screws — Oval Slot. 6-32 x 1"; 8-32 x 1", 1-1/2; 10-24 x 1-1/2; 1/4-20 x 2". Hex Machine Screw Nuts. 6-32, 8-32, 10-24, 1/4-20. Finishing Washers — Countersunk. No. 6, 8, 10. Refer to page 163.</p> <p>SPEE-DRILL SCREWS 020-617 Contains 1000 Screws. 6 x 3/8; 7 x 1/2; 8 x 1/2; 10 x 1/2, 3/4. Also includes Magnetic Chuck. Refer to page 73.</p> <p>COTTER PINS NO. 020-618 Contains 1230 Pins. 1/16 x 1/2, 3/4, 1", 1-1/4, 1-1/2; 3/32 x 3/4, 1", 1-1/4; 1/8 x 1-1/2, 1-3/4, 2"; 5/32 x 1-1/2, 2"; 3/16 x 1-1/2, 2". Refer to page 47.</p> <p>S.A.E. WASHERS NO. 020-619 Contains 1200 Washers. 1/8, 3/16, 1/4, 5/16, 3/8, 7/16, 1/2, 9/16, 5/8, 3/4, 7/8, 1". Refer to page 54.</p> <p>PLAIN STEEL WASHERS NO. 020-620 Contains 1615 Washers. 1/8, 3/16, 1/4, 5/16, 3/8, 7/16, 1/2, 9/16, 5/8, 3/4. Refer to page 53.</p> |
|--|--|---|

* For these Assortments see current 'Papco' Brass Fittings catalogue.





papco MASTER ASSORTMENTS

| | | |
|---|--|--|
|  <p>LOCK WASHERS NO. 020-621 Contains 1257 Washers. 1/8, 5/32, 3/16, 1/4, 5/16, 3/8, 7/16, 1/2, 9/16, 5/8, 3/4, 7/8, 1". Refer to pages 55, 56.</p> |  <p>UTILITY SPRINGS NO. 020-637 Contains 250 Compression, Extension and Throttle Springs. 311-601, 602, 603, 604, 605, 606, 607, 608, 610, 611, 612, 615, 616, 617, 618, 622, 623, 624, 628, 631, 632, 635, 636, 650, 653, 655, 656, 658, 661, 676, 677, 678. Refer to pages 143, 144.</p> |  <p>CHROME TRIM SCREWS NO. 020-661 Contains 350 Screws. 229-806, 811, 815, 819, 833, 837, 985, 986, 230-203, 205, 206, 207, 301, 302, 304, 305. Refer to page 73.</p> |
|  <p>BOLTS, NUTS, SCREWS NO. 020-622 Cap Screws (U.N.C.), Nuts (U.N.C.), Lock Washers, S.A.E. Washers, Stove Bolts (Round Head). Contains 155 Screws, 143 Nuts, 924 Washers, 145 Bolts. Cap Screws — 1/4 x 3/4, 1"; 5/16 x 3/4, 1"; 3/8 x 1", 1-1/2. Nuts — 1/4, 5/16, 3/8. Lock Washers — 1/4, 5/16, 3/8. S.A.E. Washers — 1/4, 5/16, 3/8. Stove Bolts — 3/16 x 1"; 1/4 x 3/4, 1". Refer to pages 29, 30.</p> |  <p>EXHAUST SYSTEM FASTENERS NO. 020-639 Contains 170 pieces. Cap Screws — 5/16-18 x 1-1/4, 1-1/2, 2"; 3/8-16 x 1-1/2, 2", 4-1/2, 5-1/2; 7/16-14 x 2"; 9/16-12 x 2". Brass Nuts — 264-955, 958, 959, 957. Steel Nuts — 264-903, 905, 908. Carriage Bolts — 5/16 x 1-1/2; 3/8 x 1-1/2. Hex Nuts — 5/16-18, 3/8-16, 7/16-14, 9/16-12. Refer to pages 114, 115.</p> |  <p>BLACK TRIM SCREWS NO. 020-662 Contains 350 Screws. 229-401, 402, 403, 405, 407, 414, 416, 849, 851, 855, 883, 887, 911, 915, 919, 933, 937, 945, 962, 968, 972, 980, 982, 987, 988; 230-303, 306. Refer to page 73.</p> |
|  <p>MACHINE SCREWS NO. 020-623 Round and Oval Head — Phillips. Contains 393 Screws, 393 Nuts. Round — 6-32 x 3/8, 1/2; 8-32 x 3/8, 1/2, 3/4, 1"; 10-32 x 1/2, 3/4; 10-24 x 1/2; 1/4-20 x 1/2, 3/4, 1". Oval — 8-32 x 1/2; 10-32 x 1/2; 10-24 x 3/4. Nuts — 6-32, 8-32, 10-32, 10-24, 1/4-20. Refer to page 65.</p> |  <p>EXPANSION PLUGS NO. 020-640 Contains 140 Standard and Cup Types. 260-008, 010, 014, 018, 020, 024, 028, 030, 036, 039, 045, 054, 057, 069, 114, 159, 174, 186, 194. Refer to page 121.</p> |  <p>METRIC EXPANSION PLUGS NO. 020-666 Contains 120 Standard and Cup Types. 261-024, 046, 090, 100, 107, 126, 132, 145, 155, 161, 165, 177, 182, 184, 185, 188. Refer to page 121.</p> |
|  <p>MACHINE SCREWS NO. 020-624 Round and Flat Head Square Drive. Contains 560 Screws, 560 Nuts. Round — 6-32 x 3/8, 1/2, 1", 1-1/2; 8-32 x 3/4, 1", 1-1/2; 10-32 x 1/2, 1", 1-1/2; 1/4-20 x 3/4, 1", 1-1/4. Flat — 6-32 x 3/8, 1/2, 1"; 8-32 x 1/2, 3/4, 1", 1-1/2; 10-32 x 1/2, 1", 1-1/2; 1/4-20 x 1". Nuts — 6-32, 8-32, 10-32, 10-24, 1/4-20. Refer to pages 63, 64.</p> |  <p>CLEVIS PINS NO. 020-641 Contains 78 Pins. 255-044, 054, 064, 074, 086, 203, 221, 224, 225, 226, 228, 235, 236, 237, 241, 244, 245, 246, 251, 248. Refer to pages 46.</p> |  <p>BLIND RIVETS NO. 020-667 Contains 1200 pieces. 239-492, 493, 494, 611, 617, 653, 714, 717, 750, 753, 811, 814, 817. Refer to pages 80, 81.</p> |
|  <p>MACHINE SCREWS NO. 020-624 Round and Flat Head Square Drive. Contains 560 Screws, 560 Nuts. Round — 6-32 x 3/8, 1/2, 1", 1-1/2; 8-32 x 3/4, 1", 1-1/2; 10-32 x 1/2, 1", 1-1/2; 1/4-20 x 3/4, 1", 1-1/4. Flat — 6-32 x 3/8, 1/2, 1"; 8-32 x 1/2, 3/4, 1", 1-1/2; 10-32 x 1/2, 1", 1-1/2; 1/4-20 x 1". Nuts — 6-32, 8-32, 10-32, 10-24, 1/4-20. Refer to pages 63, 64.</p> |  <p>SPRING PINS NO. 020-642 Contains 275 Pins. 3/32 x 1/2, 3/4, 1"; 1/8 x 1/2, 3/4, 1"; 5/32 x 3/4, 1", 1-1/2; 3/16 x 3/4, 1", 1-1/2; 1/4 x 1-1/2, 2"; 5/16 x 1", 1-1/2, 2"; 3/8 x 1-1/2, 2". Refer to pages 133.</p> |  <p>'DRILL-X' SELF-TAPPING SCREWS NO. 020-668 Contains 395 Screws. Complete Coverage. Refer to page 76.</p> |
|  <p>MACHINE SCREWS NO. 020-624 Round and Flat Head Square Drive. Contains 560 Screws, 560 Nuts. Round — 6-32 x 3/8, 1/2, 1", 1-1/2; 8-32 x 3/4, 1", 1-1/2; 10-32 x 1/2, 1", 1-1/2; 1/4-20 x 3/4, 1", 1-1/4. Flat — 6-32 x 3/8, 1/2, 1"; 8-32 x 1/2, 3/4, 1", 1-1/2; 10-32 x 1/2, 1", 1-1/2; 1/4-20 x 1". Nuts — 6-32, 8-32, 10-32, 10-24, 1/4-20. Refer to pages 63, 64.</p> |  <p>SPEED NUTS NO. 020-643 Contains 467 Push-on and Tubular Types. 240-310, 315, 320, 325, 330, 331, 335, 340, 350, 355, 360, 365, 370, 375, 380, 405, 410, 430, 431, 450, 470, 471. Refer to page 88.</p> |  <p>6-LOBE TRIM SCREWS NO. 020-669 Contains 240 Screws. Complete Coverage. Refer to page 77.</p> |
|  <p>TOOTH LOCK WASHERS NO. 020-625 Internal and External Types Plated. Contains 1370 Washers. 161-106, 108, 110, 114, 118, 120, 122, 124, 128, 132, 206, 208, 210, 214, 218, 220, 222, 224, 228, 232. Refer to page 57.</p> |  <p>SPRING PINS NO. 020-642 Contains 275 Pins. 3/32 x 1/2, 3/4, 1"; 1/8 x 1/2, 3/4, 1"; 5/32 x 3/4, 1", 1-1/2; 3/16 x 3/4, 1", 1-1/2; 1/4 x 1-1/2, 2"; 5/16 x 1", 1-1/2, 2"; 3/8 x 1-1/2, 2". Refer to pages 133.</p> |  <p>FLANGED BOLTS AND NUTS NO. 020-670 Contains 145 Bolts and Nuts. 244-425, 520, 523, 540, 625, 630, 640, 645, 650, 695, 699, 899, 986, 987, 988, 990; 245-122, 225, 325, 516. Refer to page 93.</p> |
|  <p>UNIVERSAL O-RINGS NO. 020-626 Contains 300 Rings. Complete coverage. Refer to page 135.</p> |  <p>SPEED NUTS NO. 020-644 Contains 421 Formed and Flat Types. 240-090, 091, 097, 100, 101, 107, 120, 121, 125, 127, 160, 210, 220, 227, 248, 249, 260, 263, 267, 268. Refer to page 88.</p> |  <p>MARINE FASTENERS NO. 020-673 Contains 500 pieces. 18.8 Stainless Steel Fasteners. Tapping Screws — 4 x 1/2; 6 x 3/4; 8 x 3/4, 1"; 10 x 1" — Pan and Oval Slot. Wood Screws — 6 x 3/4; 8 x 3/4, 1"; 10 x 1", 1-1/2. Machine Screws — 6-32 x 1/2; 8-32 x 1"; 10-24 x 1-1/2; 1/4-20 x 2". Nuts — 6-32, 8-32, 10-24, 1/4-20. Finishing Washers — No. 6, 8, 10, 1/4. Refer to page 164.</p> |
|  <p>SNAP RINGS NO. 020-627 Contains 401 Rings — 36 sizes. 268-222, 224, 226, 227, 230, 231, 232, 234, 237, 238, 242, 246, 329, 330, 332, 414, 418, 422, 424, 426, 428, 430, 505, 506, 511, 514, 516, 518, 520, 522, 606, 610, 614, 616, 618, 620. Refer to page 126.</p> |  <p>CASTER AND CAMBER SHIMS NO. 020-645 Contains 310 Shims. 250-081, 082, 083, 091, 092, 093, 095, 096, 097, 098, 105, 106, 107, 108, 166, 168, 170, 176, 177, 178, 179, 192, 193, 194, 195, 282, 283, 284. Refer to page 111.</p> |  <p>'PALNUT' FASTENERS NO. 020-674 Contains 325 pieces. 242-016, 018, 108, 110, 114, 116, 207, 209, 211, 215, 216, 314, 316, 318, 406, 408, 410, 413; 243-004, 106, 204, 306, 308, 310, 404, 405. Refer to page 90.</p> |
|  <p>BATTERY HOLD-DOWN BOLTS NO. 020-628 Contains 130 pieces. 570-610, 611, 612, 613, 614, 615, 617. Refer to page 162.</p> |  <p>CAP SCREWS NO. 020-646 Contains 208 U.N.F. Fine Thread. Grade 5 Plated. 1/4 x 1/2, 3/4, 1", 1-1/2, 2"; 5/16 x 3/4, 1", 1-1/4; 5/16 x 1-1/2, 2"; 3/8 x 1", 1-1/2, 2"; 7/16, 1", 1-1/2, 2"; 1/2 x 1-1/2, 2"; 5/8 x 1-1/2, 2". Refer to page 28, 29.</p> |  <p>HEADLAMP SCREWS NO. 020-675 General Motors. Contains 50 Screws and Nuts. Complete coverage. Refer to page 105.</p> |
|  <p>SOCKET SET SCREWS NO. 020-629 Contains 166 Screws. 138-132, 133, 184, 185, 301, 303, 305, 437, 438, 440, 483, 575; 139-184, 301, 437. Refer to pages 40, 42.</p> |  <p>CAP SCREWS NO. 020-647 Contains 208 U.N.C. Coarse Thread. Grade 5 Plated. Same sizes as listed for 020-646.</p> |  <p>HEADLAMP SCREWS NO. 020-676 Chrysler and Ford. Contains 50 Screws and Nuts. Complete coverage. Refer to page 106.</p> |
|  <p>PERMA-THREAD INSERTS NO. 020-631 Includes contents of one Repair Kit of each 10-24, 1/4-20, 5/16-18, 3/8-16, 7/16-14, 1/2-13 and 14mm with 3/8, 7/16, 1/2 and 3/4 reach. Includes Inserts, Taps, Installation Tools, and Instructions. Refer to page 165.</p> |  <p>HEX NUTS NO. 020-648 Contains 376 Nuts. U.N.C., U.N.F. and Thick Slotted. 1/4, 5/16, 3/8, 7/16, 1/2, 5/8, 3/4. Refer to pages 29, 31.</p> |  <p>ANCHOR GROMMETS AND NUTS NO. 020-678 Contains 295 Grommets and Nuts. 247-610, 611, 620, 625, 630, 650, 660, 665, 670, 710, 715, 720, 730, 735, 811, 812, 815, 820, 826, 830, 840. Refer to pages 102, 103.</p> |
|  <p>MANIFOLD STUDS AND NUTS NO. 020-632 Contains 80 pieces. Studs — 264-048, 049, 060, 094. Nuts — 264-954, 955, 956, 957, 958, 959. Refer to pages 114, 115.</p> |  <p>POZI-LOK NUTS NO. 020-649 Contains 175 of both U.N.C. Coarse and U.N.F. Fine Threads. 1/4, 5/16, 3/8, 7/16, 1/2, 9/16, 5/8, 3/4. Refer to page 35.</p> |  <p>TRIM FASTENERS NO. 020-679 General Motors. Contains 150 Fasteners. 247-012, 053, 056, 061, 080, 082, 085, 090, 101, 150, 210, 211, 212, 215, 216, 222, 235, 248, 249, 250. Refer to pages 100, 101.</p> |
|  <p>EXPANSION PLUGS NO. 020-633 Contains 110 Cup and Shallow Cup Types. 260-114, 120, 130, 142, 144, 159, 168, 174, 186, 194, 198, 219, 311, 327, 333, 339, 365, 368. Refer to page 121.</p> |  <p>WIRING TERMINALS NO. 020-650 Contains 325 Wiring Terminals Complete coverage. Refer to page 157.</p> |  <p>TRIM FASTENERS NO. 020-680 Chrysler and Ford. Contains 150 Fasteners. 247-025, 038, 052, 055, 062, 065, 110, 136, 165, 211, 215, 230, 231, 232, 236, 237, 238, 245, 252, 253. Refer to pages 100, 101.</p> |
|  <p>DRAIN PLUGS NO. 020-635 Contains 40 Plugs and 85 Gaskets. 260-902, 903, 904. 263-710, 711, 712, 713, 781, 784, 794, 815, 816, 817, 820, 824, 828, 855, 856, 857, 860, 911, 913, 914, 916, 918, 920. Refer to pages 129, 130.</p> |  <p>WHEEL PARTS NO. 020-658 Contains 125 Bolts and Nuts. Universal. 558-014, 016, 027; 559-150; 560-103, 114, 138, 148, 155, 167, 172, 173, 386; 561-108, 109, 110, 129, 212, 248, 251. Refer to page 154.</p> |  <p>REVEAL WINDSHIELD CLIPS NO. 020-681 Contains 125 Clips. 246-409, 410, 411, 412, 413, 414, 415, 416, 417, 418, 419, 420, 425, 426, 427, 428, 429, 435, 436, 438. Refer to page 98.</p> |
|  <p>SQUARE HEAD SET SCREWS NO. 020-636 Contains 82 Screws. 1/4 x 1/2, 3/4, 1"; 5/16 x 1/2, 3/4, 1", 1-1/2; 3/8 x 1/2, 3/4, 1", 1-1/4, 1-1/2; 7/16 x 3/4, 1", 1-1/2; 1/2 x 3/4, 1", 1-1/4, 1-1/2, 2". Refer to page 39.</p> |  <p>TAPPING SCREWS NO. 020-660 Pan Head-Socket. Contains 1000 Screws. 4 x 3/8, 1/2; 6 x 3/8, 1/2, 3/4, 1"; 8 x 3/8, 1/2, 5/8, 3/4, 1", 1-1/4, 1-1/2; 10 x 1/2, 3/4, 1", 1-1/4, 1-1/2, 2"; 12 x 3/4, 1", 1-1/4; 14 x 1", 1-1/2, 2". Refer to pages 68, 69.</p> | |

PAPCO MASTER ASSORTMENTS



| | | |
|---|--|--|
|  <p>TRIM FASTENERS NO. 020-682 Import. Contains 100 pieces. 246-350, 351, 352, 353, 354, 355, 356, 357, 358, 359, 360 ; 247-069, 073, 074, 075, 076, 077, 308, 490, 491, 493, 494, 850, 851, 852, 853, 854, 855, 856, 857, 858, 859, 860. Refer to pages 97-104.</p> |  <p>BODY BOLTS NO. 020-691 Contains 150 Bolts. 245-322, 325, 400, 405, 407, 420, 424, 425, 440, 450, 505, 507, 510, 525, 527, 610, 615, 516, 620, 630. Refer to page 92.</p> |  <p>METRIC WASHERS NO. 020-727 Contains 1000 Flat, Lock and Spring Washers. 4mm, 5mm, 6mm, 8mm, and 10 mm of all three types. Refer to page 26.</p> |
| <p>PCV VALVE GROMMETS NO. 020-683 Contains 42 Grommets. 263-201, 202, 203, 204, 205, 206, 207, 208, 209, 210, 211, 212, 213, 214, 215, 216, 217, 218, 225, 226. Refer to page 124.</p> | <p>'U' NUTS NO. 020-692 Contains 100 Nuts. 240-614, 615, 616, 617, 618, 619, 706, 708, 709, 710, 714, 715 ; 241-604, 605, 606, 607, 608, 609, 610, 612. Refer to page 91.</p> | <p>METRIC SOCKET SET SCREWS AND MACHINE SCREWS NO. 020-728 Contains 100 Set Screws. M4 x 5, 10 ; M5 x 10, 15 ; M6 x 8, 12, 20 ; M8 x 8, 12, 20 ; plus M2, 2.5, 3, 4 Keys. Contains 140 Machine Screws and Nuts. M4 x 6, 12 ; M5 x 10, 16 ; M6 x 10, 16, 20 — Screws. M4, 5, 6 — Nuts. Refer to page 26.</p> |
| <p>MOULDING CLIPS NO. 020-684 General Motors. Contains 100 Clips. 246-112, 114, 120, 122, 124, 212, 216, 310, 316, 320, 395, 396, 397, 398, 399, 400, 401, 402, 408. Refer to page 97.</p> | <p>'PLASTI-RIVETS' NO. 020-693 Contain 150 Rivets. 247-300, 301, 302, 303, 304, 305, 306, 307, 401, 402, 403, 405, 406, 407, 411, 462, 464, 466, 467, 468. Refer to pages 82, 104.</p> | <p>METRIC COTTER AND SPRING PINS NO. 020-729 Contains 675 Cotter Pins. 1.5 x 16 ; 2 x 20 ; 3 x 25, 40 ; 4 x 50. Contains 160 Spring Pins. 2 x 16 ; 2.5 x 18 ; 3 x 24, 40 ; 4 x 18, 36, 50 ; 5 x 36, 50 ; 6 x 22, 50. Refer to page 26.</p> |
| <p>GREASE FITTINGS NO. 020-685 Contains 160 Inch and Metric Fittings. 904-610, 612, 613, 363, 641, 652, 688, 691, 701, 702, 703, 745, 746, 747, 790, 791, 792. Refer to page 171.</p> | <p>METRIC CAP SCREWS AND NUTS NO. 020-725 Contains 570 Cap Screws and Nuts. M4 x 16 ; M5 x 12, 16, 20, 25 ; M6 x 12, 16, 20, 25, 30, 35, 45 — Cap Screws M4, 5, 6 — Nuts and Lock Nuts. Refer to page 26.</p> | <p>METRIC COTTER AND SPRING PINS NO. 020-729 Contains 675 Cotter Pins. 1.5 x 16 ; 2 x 20 ; 3 x 25, 40 ; 4 x 50. Contains 160 Spring Pins. 2 x 16 ; 2.5 x 18 ; 3 x 24, 40 ; 4 x 18, 36, 50 ; 5 x 36, 50 ; 6 x 22, 50. Refer to page 26.</p> |
| <p>MOULDING CLIPS NO. 020-688 Chrysler and Ford. Contains 100 Clips. 246-112, 120, 122, 124, 126, 218, 222, 226, 228, 230, 320, 324, 400, 403, 405, 407. Refer to page 97.</p> | <p>METRIC CAP SCREWS AND NUTS NO. 020-726 Contains 186 Cap Screws and Nuts. M8 x 12, 16, 20, 25, 30, 40, 60, 70 ; M10 x 30, 40, 50, 60, 70 — Cap Screws M8, 10 — Nuts and Lock Nuts. Refer to page 26.</p> | <p>METRIC CAP SCREWS AND NUTS NO. 020-730 Fine and Extra Fine Thread. Contains 130 Cap Screws and Nuts. 609-320, 324, 368, 370, 372, 374, 416, 418 ; 610-366, 368, 372, 374, 414, 416, 418 ; 670-208, 210, 212, 750, 765, Refer to page 26.</p> |

PAPCO STAX-SIX CABINET No. 022-091

'Papco' Stax-Six Cabinet No. 022-091 holds six Master Assortments in its own rigid drawer slide. Made of heavy gauge steel with a baked-on enamel finish. Size: 15-1/2" h. x 11-3/4" d.



(Assortments or Assortment Drawers NOT included.)

- Assortments are packed in a sturdy, metal container with high-strength, moulded plastic compartments and hinged lid .
- Individual compartments separate items for quick selection.
- Illustrations and retail price codes shown on grease-resistant lid label.
- Curved, 'coin-drawer' bottom makes removal easy.
- Refill available in standard packages or 'Papco' Handy-Paks.
- Carrying handle and safety snap lock for greater convenience.
- Merchandiser size:
9-3/4" w. x 13-3/4" l. x 2" d.



Papco 'SUPER-SERVICE' ASSORTMENTS

Perfect for Dealers, Jobbers and large users.
These popular assortments have a wide range
of carefully selected items in balanced quantities.

Papco STAX FOUR CABINET No. 022-093

- Welded steel construction.
- Rigid drawer slide.
- Baked black enamel finish.
- No-spill safety feature.







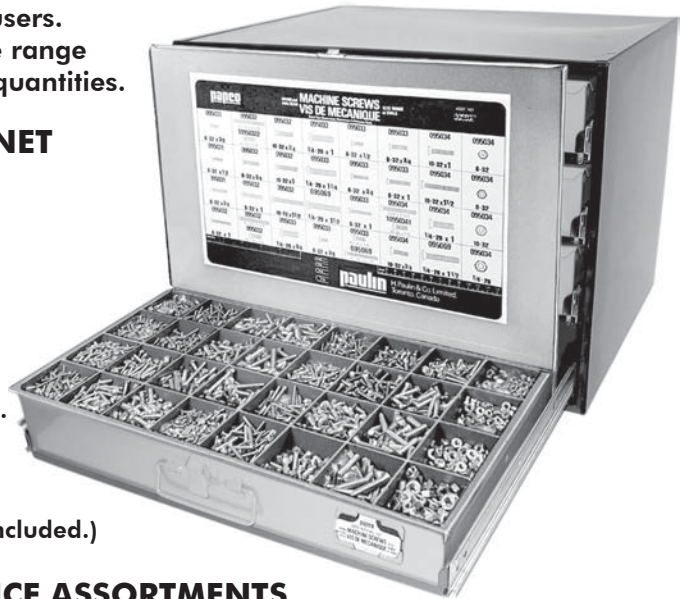















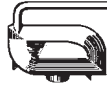

Each 'Papco' STAX-FOUR Cabinet
holds four Super-Service Assortments.

Stax-Four Cabinet No. 022-093
Size: 20" w. x 14-1/2" h. x 15-3/4" d.

(Assortments or Assortment Drawers NOT included.)

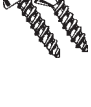
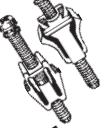

SUPER SERVICE ASSORTMENTS

| | | |
|--|---|---|
|  <p>EXPANSION PLUGS NO. 020-800 Contains 200 Standard and Cup Types. 260-008, 010, 014, 018, 020, 024, 028, 030, 036, 039, 045, 054, 057, 114, 120, 130, 142, 144, 159, 165, 168, 174, 177, 180, 186, 194, 198, 204, 240. Refer to page 121.</p> |  <p>TAPPING SCREWS NO. 020-808 Contains 650 Hex Head Tapping Screws and Fender Washers. Complete coverage of Hex Head Tapping Screws. Fender Washers — 162-394, 395, 396, 397, 398, 399. Refer to page 69.</p> |  <p>SNAP RINGS NO. 020-817 Contains 705 Snap Rings - 50 Sizes. Complete coverage 268-222 to 724. Refer to page 126.</p> |
|  <p>EXPANSION PLUGS NO. 020-801 Contains 170 Cup and Shallow Cup Types. 260-114, 118, 120, 130, 142, 144, 159, 165, 168, 174, 177, 180, 186, 194, 198, 204, 207, 219, 240, 311, 318, 327, 333, 339, 351, 365, 368, 370, 372, 378. Refer to page 121.</p> |  <p>PHILLIPS TRIM SCREWS NO. 020-809 Contains 1225 Phillips Screws. 229-010, 012, 022, 024, 026, 044, 110, 120, 122, 140, 142, 164, 220, 222, 224, 226, 228, 240, 242, 244, 248, 250, 252 ; 230-203, 205, 207, 301, 302, 304, 305. Refer to page 74.</p> |  <p>ENGINE STUDS AND NUTS NO. 020-818 Contains 295 Engine Studs and Nuts. Studs — 264-018, 024, 032, 048, 049, 060, 066, 086, 088, 094, 096, 134, 150. Metric Studs — 264-231, 328, 335, 338, 346, 443, 450, 451. Nuts — 264-953, 954, 955, 956, 958, 959, 960, 961. Metric Nuts — 670-006, 008, 010. Refer to page 115.</p> |
|  <p>WHEEL PARTS NO. 020-802 Contains 180 Bolts and Nuts. Universal. 558-014, 016, 027 ; 559-125, 150 ; 560-102, 103, 105, 114, 138, 148, 155, 167, 172, 173, 386, 604 ; 561-100, 102, 106, 108, 109, 110, 111, 120, 129, 154, 166, 167, 212, 248, 251. Refer to page 154.</p> |  <p>SPEED NUTS NO. 020-810 Contains 685 Speed Nuts in Flat, Push-on and Formed Types. 240-090, 091, 097, 100, 101, 107, 120, 121, 125, 127, 160, 210, 220, 227, 228, 243, 245, 246, 247, 248, 249, 260, 263, 267, 268, 335, 350, 355, 360, 365, 370. Refer to page 88.</p> |  <p>SPRING PINS NO. 020-819 Contains 770 Spring Pins. 1/16 x 1/2, 3/4, 1" ; 3/32 x 1/2, 3/4, 1" ; 1/8 x 3/8, 1/2, 3/4, 1" ; 1-1/4, 1-1/2, 2" ; 5/32 x 1/2, 3/4, 1" ; 1-1/2 ; 3/16 x 1/2, 3/4, 1" ; 1-1/2, 2" ; 1/4 x 3/4, 1", 1-1/2, 2" ; 5/16 x 1", 1-1/2, 2" ; 3/8 x 1", 1-1/2, 2". Refer to page 133.</p> |
|  <p>SOCKET SET SCREWS NO. 020-803 Contains 240 Set Screws and Keys. Complete coverage of Socket Set Screws plus 140-101, 102, 103, 104, 107, 108, 110, and 111 Hex Keys. Refer to pages 40-42.</p> |  <p>PALNUT FASTENERS NO. 020-811 Contains 500 Regular and Self-Threading Palnuts plus Bolt Retainers and Pushnuts. 242-016, 018, 020, 022, 110, 114, 116, 206, 207, 208, 209, 210, 211, 214, 215, 216, 314, 316, 318, 406, 408, 410, 414, 416, 418 ; 243-004, 106, 204, 306, 308, 310, 404. Refer to page 90.</p> |  <p>WOODRUFF KEYS NO. 020-820 Contains 374 Woodruff Keys. 302-010, 020, 030, 040, 050, 060, 061, 070, 080, 090, 091, 100, 110, 120, 121, 130, 140, 150, 152, 160, 170, 180, 183, 190, 200, 210, 214, 220, 240, 250, 270, 280. Refer to page 134.</p> |
|  <p>FLAT AND LOCK WASHERS NO. 020-804 Contains 3020 Plain, S.A.E., Lock, Tooth Lock and Fender Washers. Flat — 3/16, 1/4, 5/16, 3/8, 7/16, 1/2. S.A.E. — No. 8, 10, 1/4, 5/16, 3/8, 7/16, 1/2. Lock — No. 8, 10, 1/4, 5/16, 3/8, 7/16, 1/2. Int. Tooth — 3/16, 1/4, 5/16, 3/8. Ext. Tooth — 3/16, 1/4, 5/16, 3/8. Fender — 162-395, 396, 398, 399. Refer to page 56.</p> |  <p>WIRING TERMINALS NO. 020-812 Contains 500 Terminals. Complete coverage. Refer to page 156.</p> |  <p>UNIVERSAL O-RINGS NO. 020-821 Contains 390 O-Rings. Complete coverage. Refer to page 135.</p> |
|  <p>COTTER PINS NO. 020-805 Contains 3345 Cotter Pins and Throttle Rod Retainers. 1/16 x 1/2, 3/4, 1", 1-1/4, 1-1/2 ; 3/32 x 3/4, 1", 1-1/4, 2" ; 1/8 x 3/4, 1", 1-1/4, 1-1/2, 1-3/4, 2" ; 5/32 x 1", 1-1/4, 1-1/2, 2" ; 3/16 x 1", 1-1/4, 1-1/2, 2". Retainers — 262-203, 205, 206, 208, 210, 214, 216, 218. Refer to page 47.</p> |  <p>TRIM FASTENERS NO. 020-813 Contains 300 Trim and Weatherstrip Fasteners plus Shield Retainers. Complete coverage (except 247-026). Refer to page 101.</p> |  <p>MOULDING BOLTS NO. 020-822 Universal. Contains 195 Moulding Bolts. Complete coverage 246-112 to 324. Refer to page 96.</p> |
|  <p>MACHINE SCREWS AND NUTS NO. 020-806 Contains 2750 Round and Flat Sq. Drive Screws and Nuts. Round — 6-32 x 3/8, 1/2, 3/4, 1", 1-1/2 ; 8-32 x 1/2, 3/4, 1", 1-1/2 ; 10-32 x 1/2, 3/4, 1", 1-1/2 ; 1/4-20 x 3/4, 1", 1-1/4, 1-1/2. Flat — 6-32 x 3/8, 1/2, 3/4, 1", 1-1/2 ; 8-32 x 1/2, 3/4, 1", 1-1/2 ; 10-32 x 1/2, 3/4, 1", 1-1/2 ; 1/4-20 x 1", 1-1/2. Nuts — 6-32, 8-32, 10-32, 1/4-20. Refer to page 64.</p> |  <p>ANCHOR GROMMETS AND NUTS NO. 020-814 Contains 465 Grommets and Nuts. 247-610, 611, 615, 620, 621, 650, 655, 660, 665, 670, 710, 715, 720, 725, 730, 735, 810, 811, 812, 815, 820, 826, 830, 840, 821, 825. Refer to page 102-103.</p> |  <p>'U' NUTS AND BODY BOLTS NO. 020-823 Contains 329 'U' Nuts and Body Bolts. Complete coverage of 240-614 to 715 and 245-322 to 616. Refer to page 88.</p> |
|  <p>TAPPING SCREWS NO. 020-807 Contains 1450 Pan & Oval Slot Tapping Screws. Pan — 6 x 3/8, 1/2, 3/4, 1", 1-1/4 ; 8 x 3/8, 1/2, 3/4, 1", 1-1/4, 1-1/2 ; 10 x 1/2, 3/4, 1", 1-1/4, 1-1/2 ; 12 x 3/4, 1", 1-1/4 ; 14 x 1", 1-1/4. Oval — 6 x 1/2, 3/4, 1" ; 8 x 1/2, 3/4, 1" ; 10 x 3/4, 1", 1-1/4 ; 12 x 1-1/2. Refer to page 68.</p> |  <p>HEADLAMP SCREWS NO. 020-815 Universal. Contains 105 Screws and Nuts. 247-615, 621, 665, 816, 830 ; 248-010, 015, 016, 020, 025, 026, 031, 032, 033, 035, 040, 045, 050, 055, 060, 110, 115, 116, 120, 121, 125, 210, 215, 220, 225, 226. Refer to page 106.</p> |  <p>METRIC EXPANSION PLUGS NO. 020-840 Contains 180 Metric Standard and Cup Types. 261-014, 024, 026, 046, 064, 090, 100, 107, 109, 114, 117, 124, 126, 132, 138, 145, 146, 149, 150, 155, 161, 165, 177, 182, 184, 185, 186, 188. Refer to page 121.</p> |
| |  <p>CLEVISS PINS AND CLIPS NO. 020-816 Contains 173 Standard and Universal Cleviss Pins and Clips. 255-004, 054, 064, 074, 076, 084, 086, 106, 126, 208, 221, 224, 226, 228, 231, 235, 236, 237, 239, 241, 242, 244, 246, 251 ; Hitch Pins — 255-303, 307, 310, 311, 316. Cotter Pins — 1/16 x 1/2 ; 3/32 x 3/4 ; 1/8 x 1". Refer to page 45.</p> |  <p>METRIC EXPANSION PLUGS NO. 020-841 Contains 150 Metric Cup and Shallow Cup Types. 261-100, 107, 109, 126, 132, 138, 145, 146, 149, 150, 155, 161, 162, 165, 177, 182, 184, 185, 186, 188, 326, 347, 364, 367, 377. Refer to page 121.</p> |
| | |  <p>METRIC CAP SCREWS NO. 020-842 AND NUTS Contains 535 Metric Cap Screws and Nuts. 608-139, 198, 201, 203, 205, 267, 270, 272, 274, 276, 278, 279, 311, 314, 316, 318, 320, 321, 322, 324, 326, 328, 370, 372, 374, 376, 378 ; 670-004, 005, 006, 008, 010. Refer to pages 24, 26.</p> |

Note: Contents of assortments subject to change with market

papco[®] BOLT BINS

COFFRE POUR BOULONS



Store your Cap Screws, Nuts and other fasteners in these modern, all-steel 'Papco' Bolt Bins. Every item is easy to see - your stock is kept clean, neat and always available.

40

No. 022-017 (empty)
36" wide x 24" high x 12" deep
40 Bins Size: 4-1/2 x 4-1/2 x 12

42

No. 022-018 (empty)
36" wide x 42" high x 12" deep
42 Bins Size: 5-3/8 x 5-7/16 x 12

72

No. 022-019 (empty)
36" wide x 42" high x 12" deep
72 Bins Size: 4-1/2 x 4-1/2 x 12

FEATURES

OPTIONAL STEEL DOORS
with Chrome Handles
and Magnetic Catches.

No. 022-023 for Bolt Bin No. 022-017
No. 022-025 for Bolt Bin No. 022-018
and 019

HEAVY GAUGE STEEL
Welded Construction.

'SAFETY' BIN LIPS
Avoid Spillage.

BAKED FINISH

OPTIONAL STEEL BASE
4 Inches High, Black Finish.

022-027 Base fits either model.



papco[®] MOD-U-BIN

Build a 'Papco' Bolt Bin as large as you need. New modular design allows you to mount additional bins to the top, bottom or sides.

- Heavy gauge steel construction.
- 12 Large hand size compartments.
- Baked orange enamel finish.
- Label holder rails.

Mount anywhere, on the wall, on a workbench or on the floor.

12

No. 022-020 (empty)
17" w. x 16-1/2" h. x 6-1/4" d.
12 Bins Size: 4-1/4 x 5-1/2 x 6-1/4



Papco BOLT BIN ASSORTMENTS ASSORTIMENTS DE BOULONS



PLATED GRADE 5 CAP SCREWS AND NUTS No. 022-021

72 Popular Sizes - Over 4,750 Pieces.

| UNC Cap Screws | | UNC Cap Screws | | UNF Cap Screws | |
|----------------|--------------|-----------------------|--------------|---------------------|---------|
| 100 | 1/4 x 3/4 | 25 | 5/8 x 4 | 25 | 5/8 x 2 |
| 100 | 1/4 x 1 | 25 | 5/8 x 5 | 25 | 5/8 x 3 |
| 100 | 1/4 x 1-1/2 | 20 | 3/4 x 2-1/2 | 25 | 5/8 x 4 |
| 100 | 5/16 x 3/4 | 20 | 3/4 x 3 | 20 | 3/4 x 3 |
| 100 | 5/16 x 1 | 20 | 3/4 x 4 | 20 | 3/4 x 4 |
| 100 | 5/16 x 1-1/2 | 20 | 3/4 x 5 | UNC Hex Nuts | |
| 100 | 5/16 x 2 | 20 | 3/4 x 6 | | |
| 100 | 3/8 x 1 | 20 | 7/8 x 2-1/2 | 300 | 1/4 |
| 100 | 3/8 x 1-1/2 | 20 | 7/8 x 3 | 200 | 5/16 |
| 100 | 3/8 x 2 | 20 | 7/8 x 4 | 200 | 3/8 |
| 100 | 3/8 x 2-1/2 | 20 | 1 x 3 | 50 | 7/16 |
| 100 | 3/8 x 3 | 10 | 1 x 4 | 50 | 1/2 |
| 50 | 7/16 x 1-1/2 | UNC Cap Screws | | 25 | 9/16 |
| 50 | 7/16 x 2 | 100 | 1/4 x 1 | 25 | 5/8 |
| 50 | 7/16 x 3 | 100 | 1/4 x 1-1/2 | 20 | 3/4 |
| 50 | 1/2 x 1 | 100 | 5/16 x 1 | 20 | 7/8 |
| 50 | 1/2 x 1-1/2 | 100 | 5/16 x 1-1/2 | 20 | 1 |
| 50 | 1/2 x 2 | 100 | 5/16 x 2 | UNF Hex Nuts | |
| 50 | 1/2 x 2-1/2 | 100 | 3/8 x 1 | 200 | 1/4 |
| 50 | 1/2 x 3 | 100 | 3/8 x 2 | 200 | 5/16 |
| 50 | 1/2 x 4 | 50 | 7/16 x 1-1/2 | 200 | 3/8 |
| 25 | 9/16 x 2 | 50 | 1/2 x 2 | 100 | 7/16 |
| 25 | 5/8 x 2 | 50 | 1/2 x 3 | 50 | 1/2 |
| 25 | 5/8 x 2-1/2 | 50 | 1/2 x 4 | 25 | 9/16 |
| 25 | 5/8 x 3 | 25 | 9/16 x 2 | 25 | 5/8 |
| | | | | 20 | 3/4 |



Size: 36" x 42" x 12"
DOORS AND BASE ARE OPTIONAL EXTRAS

These assortments include a set of Bolt Bin Stock Labels with space for inventory control or prices; a 'Papco' Measurement and Decimal Equivalents Chart, and Popular Fastener Order Forms.

You can also purchase 'Papco' Bolt Bins empty and make up your own custom assortments. You have the option of ordering the Doors and Base as extra items. As your requirements grow, you can add more Bolt Bins to store other Fasteners and Supplies.

PLATED GRADE 5 CAP SCREWS AND NUTS No. 022-022

40 Popular Sizes - Over 4,000 Pieces.

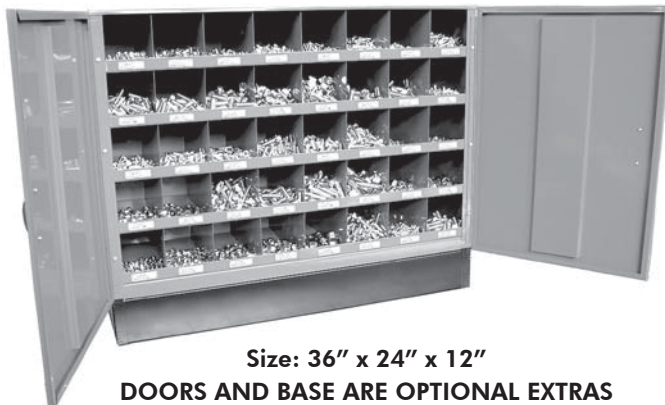

Size: 36" x 24" x 12"
DOORS AND BASE ARE OPTIONAL EXTRAS

| UNC Cap Screws | | UNC Cap Screws | | UNC Hex Nuts | |
|----------------|--------------|-----------------------|--------------|---------------------|------|
| 100 | 1/4 x 3/4 | 25 | 5/8 x 2 | 200 | 1/4 |
| 100 | 1/4 x 1 | 25 | 5/8 x 3 | 100 | 5/16 |
| 100 | 1/4 x 1-1/2 | UNF Cap Screws | | 100 | 3/8 |
| 100 | 5/16 x 3/4 | 100 | 1/4 x 1 | 100 | 7/16 |
| 100 | 5/16 x 1 | 100 | 1/4 x 1-1/2 | 100 | 1/2 |
| 100 | 5/16 x 1-1/2 | 100 | 5/16 x 3/4 | 50 | 9/16 |
| 200 | 3/8 x 1 | 200 | 5/16 x 1 | 25 | 5/8 |
| 200 | 3/8 x 1-1/2 | 100 | 5/16 x 1-1/2 | UNF Hex Nuts | |
| 200 | 3/8 x 2 | 100 | 3/8 x 1 | 200 | 1/4 |
| 100 | 7/16 x 1-1/2 | 100 | 3/8 x 1-1/2 | 100 | 5/16 |
| 100 | 1/2 x 1-1/2 | 100 | 3/8 x 2 | 100 | 3/8 |
| 100 | 1/2 x 2 | 100 | 7/16 x 1-1/2 | 100 | 7/16 |
| 100 | 1/2 x 2-1/2 | 50 | 1/2 x 2 | 100 | 1/2 |
| 25 | 9/16 x 1-1/2 | 50 | 1/2 x 2-1/2 | | |
| 25 | 9/16 x 2 | | | | |

papco BOLT-N-NUT CABINET



The `Papco` Bolt-n-Nut Cabinet was developed for Service Stations, Garages, Car Dealers, Body Shops and many other fastener users. Each compact space-saving cabinet features:



Size: 34" w. x 11" h. x 11-5/8" d.

No. 022-086 (Empty)

- All steel construction.
- 18 Man-size, no-spill drawers (11-1/4" l. x 5-1/2" w. x 3" d.)
- Colour-coded labels for ease of identification.
- Full width handles.
- Multi-divisible drawers for future additions.
- Can be mounted on bench or placed in a standard three foot shelf.

papco BOLT-N-NUT CABINET MERCHANDISERS

Merchandiser No. 022-098 INCH EXPANSION PLUGS

Includes 54 items (see page 121) one empty cabinet No. 022-086, labels and instructions

Merchandiser No. 022-099 METRIC EXPANSION PLUGS

Includes 54 items (see page 121) one empty cabinet No. 022-086, labels and instructions

Merchandiser No. 022-084 PLATED BOLTS-n-NUTS

Includes 47 items as listed below, one empty cabinet No. 022-086, labels and instructions

Merchandiser No. 022-085 BARE BOLTS-n-NUTS

Includes 47 items as listed below, one empty cabinet No. 022-086, labels and instructions

Merchandiser No. 022-087 PLATED METRIC FASTENERS

Includes 52 items as listed below, one empty cabinet No. 022-086, labels and instructions

| UNC Grade 5 Cap Scr. | | UNF Grade 5 Cap Scr. | | Flat Washers | |
|-----------------------------|--------------|----------------------|--------------|-------------------------|--------------|
| 100 | 1/4 x 3/4 | 100 | 5/16 x 3/4 | 100 | 5/16 |
| 100 | 1/4 x 1 | 100 | 5/16 x 1 | 100 | 3/8 |
| 100 | 1/4 x 1-1/2 | 100 | 5/16 x 1-1/2 | 100 | 7/16 |
| 100 | 5/16 x 3/4 | 100 | 3/8 x 1 | 100 | 1/2 |
| 100 | 5/16 x 1 | 100 | 3/8 x 1-1/2 | Lock Washers | |
| 100 | 5/16 x 1-1/2 | 100 | 3/8 x 2 | 100 | 1/4 |
| 100 | 3/8 x 1 | UNC Hex Nuts | | 100 | 5/16 |
| 100 | 3/8 x 1-1/2 | 100 | 1/4 | 100 | 3/8 |
| 100 | 3/8 x 2 | 100 | 5/16 | 100 | 7/16 |
| 50 | 7/16 x 1-1/2 | 100 | 3/8 | 100 | 1/2 |
| 50 | 7/16 x 2 | 50 | 7/16 | R.H. Stove Bolts | |
| 50 | 1/2 x 1-1/2 | 50 | 1/2 | 100 | 3/16 x 1 |
| 50 | 1/2 x 2 | UNF Hex Nuts | | 100 | 3/16 x 1-1/2 |
| 50 | 1/2 x 2-1/2 | 100 | 1/4 | 100 | 1/4 x 1 |
| UNF Grade 5 Cap Scr. | | 100 | 5/16 | Cotter Pins | |
| 100 | 1/4 x 3/4 | 100 | 3/8 | 100 | 3/32 x 1-1/2 |
| 100 | 1/4 x 1 | Flat Washers | | 100 | 1/8 x 1-1/2 |
| 100 | 1/4 x 1-1/2 | 100 | 1/4 | 100 | 1/8 x 2 |

| Cap Screws | | Cap Screws | | Lock Washers | |
|------------|---------|---------------------|----------|--|------------|
| 100 | M4 x 16 | 50 | M10 x 30 | 100 | 6mm |
| 100 | M5 x 12 | 50 | M10 x 40 | 100 | 8mm |
| 100 | M5 x 16 | 50 | M10 x 50 | 100 | 10mm |
| 100 | M5 x 20 | 25 | M10 x 60 | Fine & Extra Fine Cap Screws and Nuts | |
| 100 | M5 x 25 | 25 | M10 x 70 | 10 | M8 x 1 |
| 100 | M6 x 12 | Hex Nuts | | 10 | M10 x 1 |
| 100 | M6 x 16 | 100 | M4 | 10 | M10 x 1.25 |
| 100 | M6 x 20 | 100 | M5 | 10 | M12 x 1.25 |
| 100 | M6 x 25 | 100 | M6 | 10 | M12 x 1.5 |
| 100 | M6 x 30 | 100 | M8 | Stove Bolts | |
| 100 | M6 x 35 | 100 | M10 | 100 | M4 x 6 |
| 100 | M8 x 12 | Flat Washers | | 100 | M4 x 12 |
| 100 | M8 x 16 | 100 | 4mm | 100 | M5 x 10 |
| 100 | M8 x 20 | 100 | 5mm | 100 | M5 x 16 |
| 100 | M8 x 25 | 100 | 6mm | 100 | M6 x 10 |
| 100 | M8 x 30 | 100 | 8mm | 100 | M6 x 16 |
| 50 | M8 x 40 | 100 | 10mm | 100 | M6 x 20 |
| 50 | M8 x 50 | Lock Washers | | | |
| 25 | M8 x 60 | 100 | 4mm | | |
| 25 | M8 x 70 | 100 | 5mm | | |

Optional steel drawer dividers No. 022-088 for above cabinet. Standard Package contains 12 dividers.



papeco BULK BINS

Durable Polypropylene, coloured bins are stackable and can be divided to hold more than one part. Standard Package 12 Bins.

| Stock No. | Colour | W | D | H |
|-----------|--------|---------------------------------|----------------------------------|----|
| 022-263 | Blue | 6 ⁵ / ₈ " | 18" | 4" |
| 022-264 | Red | 6 ⁵ / ₈ " | 18" | 4" |
| 022-265 | Yellow | 6 ⁵ / ₈ " | 18" | 4" |
| 022-266 | Green | 6 ⁵ / ₈ " | 18" | 4" |
| 022-267 | Orange | 6 ⁵ / ₈ " | 18" | 4" |
| 022-268 | Blue | 6 ⁵ / ₈ " | 11 ⁵ / ₈ " | 4" |
| 022-269 | Red | 6 ⁵ / ₈ " | 11 ⁵ / ₈ " | 4" |
| 022-270 | Yellow | 6 ⁵ / ₈ " | 11 ⁵ / ₈ " | 4" |
| 022-271 | Black | Bin dividers | | |

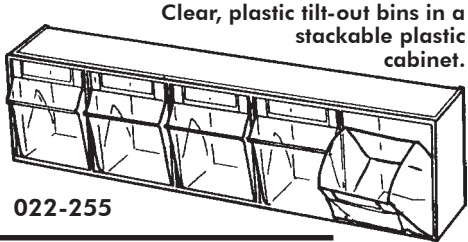
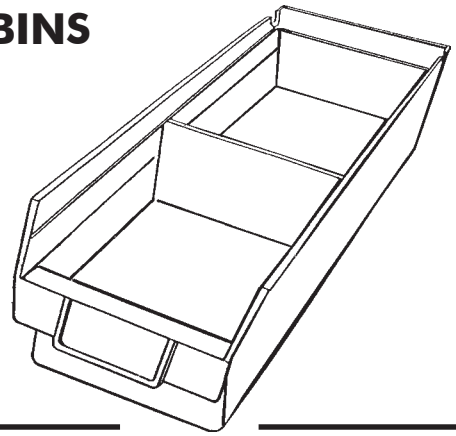

Clear, plastic tilt-out bins in a stackable plastic cabinet.

022-255

CLEAR PLASTIC BINS

| Stock No. | Description | W | D | H |
|-----------|------------------------|----------------------------------|---------------------------------|----------------------------------|
| 022-259 | 9 Compartment Tilt-Bin | 23 ⁵ / ₈ " | 2 ¹ / ₂ " | 3 ⁵ / ₁₆ " |
| 022-256 | 6 Compartment Tilt-Bin | 23 ⁵ / ₈ " | 3 ⁵ / ₈ " | 4 ¹ / ₂ " |
| 022-255 | 5 Compartment Tilt-Bin | 23 ⁵ / ₈ " | 5 ¹ / ₄ " | 6 ¹ / ₂ " |
| 022-254 | 4 Compartment Tilt-Bin | 23 ⁵ / ₈ " | 6 ⁵ / ₈ " | 8 ¹ / ₈ " |
| 022-253 | 3 Compartment Tilt-Bin | 23 ⁵ / ₈ " | 7 ³ / ₄ " | 9 ¹ / ₂ " |

papeco PLASTIC SERVICE BINS

- **DURABLE**
Frames are of heavy steel construction for long life.
- **EASY TO REMOVE**
Carry bin to the job.
- **EASY TO CLEAN**
Individual Hook-on Bins lift out.
- **EASY TO RE-ARRANGE**
Add new stock sizes as required.
- **COMPLETELY VISIBLE**
Bins have forward tilt.
- **COMPLETELY ACCESSIBLE**
Coin drawer bin bottom for easy parts removal.
- **EASY TO SERVICE**
Stock can be checked and refilled.
- **VERSATILE**
Sold empty - Choice of 5 sizes of Racks.
Free Label Service.

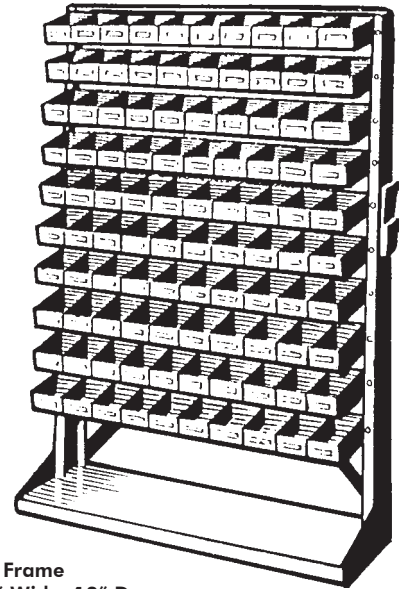

022-045
100 Bins and Frame
56" High, 41" Wide, 12" Deep

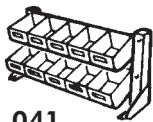

022-041
10 Bins and Frame
10" High, 21¹/₂" Wide, 8" Deep

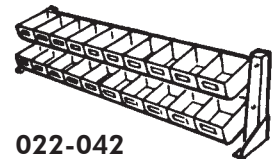

022-042
20 Bins and Frame
10" High, 41" Wide, 8" Deep

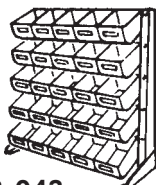

022-043
25 Bins and Frame
23" High, 21¹/₂" Wide, 8" Deep



INDIVIDUAL HOOK-ON PLASTIC BINS
022-040
Empty Service Bin
7" Long, 3³/₄" Wide, 2³/₄" Deep

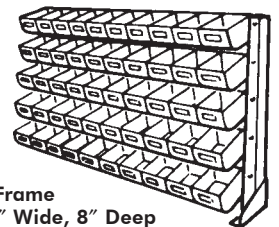

022-044
50 Bins and Frame
23" High, 41" Wide, 8" Deep

Papco HANDY-PAKS

JOBBER MERCHANDISER No. 022-067

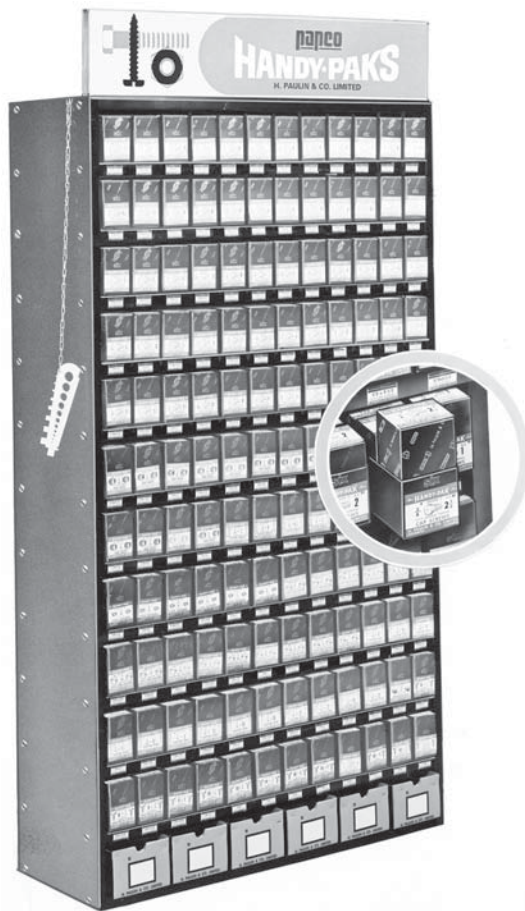

Contains 792 Handy-Packs, Rack and sign. 132 Sizes of Cap Screws, Nuts, Washers, Cotter Pins, Stove Bolts, etc.

UNIFORM PRICED PACKAGES OF FAST-MOVING HARDWARE ITEMS

- All Bright Plated Material
- No Broken Boxes
- Good For Regular Stock
- Ideal For Assortment Refills
- Best Value
- Fully Illustrated, Colour-Coded Labels



'Papco' Handy-Paks are the most modern method of stocking fasteners. They contain the most popular sizes of Bolts, Nuts, Screws and Washers as well as the best sizes of replacement parts. The available merchandisers are designed to give maximum coverage for a minimum investment.

HANDY-PAK MERCHANDISER No. 022-067 CONTENTS

| Part No. | Size | Qty. | Part No. | Size | Qty. | Part No. | Size | Qty. | Part No. | Size | Qty. |
|-------------------------------|--------------|------|-------------------------------|--------------|------|-------------------------------|--------------|------|-------------------------------------|--------------|------|
| UNF Grade 5 Cap Screws | | | UNC Grade 5 Cap Screws | | | UNC Hex Nuts | | | 023-307 | 1/2 | 6 |
| 023-101 | 1/4 x 1/2 | 6 | 023-018 | 5/16 x 1 | 12 | 023-203 | 3/8 | 12 | 023-309 | 5/8 | 6 |
| 023-103 | 1/4 x 3/4 | 6 | 023-019 | 5/16 x 1-1/4 | 6 | 023-204 | 7/16 | 12 | Cotter Pins | | |
| 023-105 | 1/4 x 1 | 6 | 023-020 | 5/16 x 1-1/2 | 12 | 023-205 | 1/2 | 6 | 023-703 | 1/16 x 1 | 6 |
| 023-107 | 1/4 x 1-1/2 | 6 | 023-022 | 5/16 x 2 | 6 | 023-207 | 5/8 | 6 | 023-705 | 1/16 x 1-1/2 | 6 |
| 023-109 | 1/4 x 2 | 6 | 023-029 | 3/8 x 3/4 | 6 | Round Head Stove Bolts | | | 023-709 | 3/32 x 1 | 6 |
| 023-116 | 5/16 x 3/4 | 6 | 023-031 | 3/8 x 1 | 12 | 023-502 | 3/16 x 3/4 | 6 | 023-710 | 3/32 x 1-1/4 | 6 |
| 023-118 | 5/16 x 1 | 12 | 023-032 | 3/8 x 1-1/4 | 12 | 023-503 | 3/16 x 1 | 6 | 023-711 | 3/32 x 1-1/2 | 6 |
| 023-119 | 5/16 x 1-1/4 | 6 | 023-033 | 3/8 x 1-1/2 | 12 | 023-505 | 3/16 x 1-1/2 | 6 | 023-715 | 1/8 x 1 | 6 |
| 023-120 | 5/16 x 1-1/2 | 6 | 023-035 | 3/8 x 2 | 12 | 023-511 | 1/4 x 3/4 | 6 | 023-716 | 1/8 x 1-1/4 | 6 |
| 023-122 | 5/16 x 2 | 6 | 023-037 | 3/8 x 2-1/2 | 6 | 023-512 | 1/4 x 1 | 6 | 023-717 | 1/8 x 1-1/2 | 12 |
| 023-131 | 3/8 x 1 | 6 | 023-042 | 7/16 x 1 | 6 | Lock Washers | | | 023-718 | 1/8 x 2 | 12 |
| 023-132 | 3/8 x 1-1/4 | 6 | 023-043 | 7/16 x 1-1/4 | 6 | 023-342 | 3/16 | 6 | 023-722 | 5/32 x 1-1/2 | 6 |
| 023-133 | 3/8 x 1-1/2 | 6 | 023-044 | 7/16 x 1-1/2 | 6 | 023-343 | 1/4 | 6 | 023-723 | 5/32 x 2 | 6 |
| 023-135 | 3/8 x 2 | 6 | 023-046 | 7/16 x 2 | 6 | 023-344 | 5/16 | 12 | Hex Machine Screw Nuts | | |
| 023-137 | 3/8 x 2-1/2 | 6 | 023-048 | 7/16 x 2-1/2 | 6 | 023-345 | 3/8 | 12 | 023-462 | 10-32 | 6 |
| 023-144 | 7/16 x 1-1/2 | 6 | 023-053 | 1/2 x 1 | 6 | 023-346 | 7/16 | 6 | Pan Head Sheet Metal Screws | | |
| 023-146 | 7/16 x 2 | 6 | 023-054 | 1/2 x 1-1/4 | 6 | 023-347 | 1/2 | 6 | 023-605 | 6 x 1/2 | 6 |
| 023-153 | 1/2 x 1 | 6 | 023-055 | 1/2 x 1-1/2 | 6 | 023-349 | 5/8 | 6 | 023-612 | 8 x 1/2 | 6 |
| 023-155 | 1/2 x 1-1/2 | 6 | 023-057 | 1/2 x 2 | 6 | S.A.E. Washers | | | 023-614 | 8 x 3/4 | 6 |
| 023-157 | 1/2 x 2 | 6 | 023-059 | 1/2 x 2-1/2 | 6 | 023-323 | 1/4 | 12 | 023-616 | 8 x 1 | 6 |
| 023-159 | 1/2 x 2-1/2 | 6 | UNF Hex Nuts | | | 023-324 | 5/16 | 12 | 023-618 | 10 x 1/2 | 6 |
| UNC Grade 5 Cap Screws | | | 023-221 | 1/4 | 12 | 023-325 | 3/8 | 12 | 023-619 | 10 x 3/4 | 6 |
| 023-001 | 1/4 x 1/2 | 6 | 023-222 | 5/16 | 12 | 023-326 | 7/16 | 6 | 023-621 | 10 x 1 | 6 |
| 023-003 | 1/4 x 3/4 | 12 | 023-223 | 3/8 | 12 | 023-327 | 1/2 | 6 | 023-628 | 14 x 3/4 | 6 |
| 023-005 | 1/4 x 1 | 6 | 023-224 | 7/16 | 6 | Plain Steel Washers | | | 023-629 | 14 x 1 | 6 |
| 023-006 | 1/4 x 1-1/4 | 6 | 023-225 | 1/2 | 6 | 023-302 | 3/16 | 6 | Oval Head Sheet Metal Screws | | |
| 023-007 | 1/4 x 1-1/2 | 6 | 023-227 | 5/8 | 6 | 023-303 | 1/4 | 6 | 023-651 | 10 x 1 | 6 |
| 023-009 | 1/4 x 2 | 6 | UNC Hex Nuts | | | 023-304 | 5/16 | 6 | Hex Head Sheet Metal Screws | | |
| 023-014 | 5/16 x 1/2 | 6 | 023-201 | 1/4 | 12 | 023-305 | 3/8 | 6 | 023-673 | 14 x 3/4 | 6 |
| 023-016 | 5/16 x 3/4 | 12 | 023-202 | 5/16 | 12 | 023-306 | 7/16 | 6 | 023-677 | 5/16 x 1 | 6 |



papco® **FASTENER CENTRE** **CENTRE DE BOULONNERIE**

No. 022-075

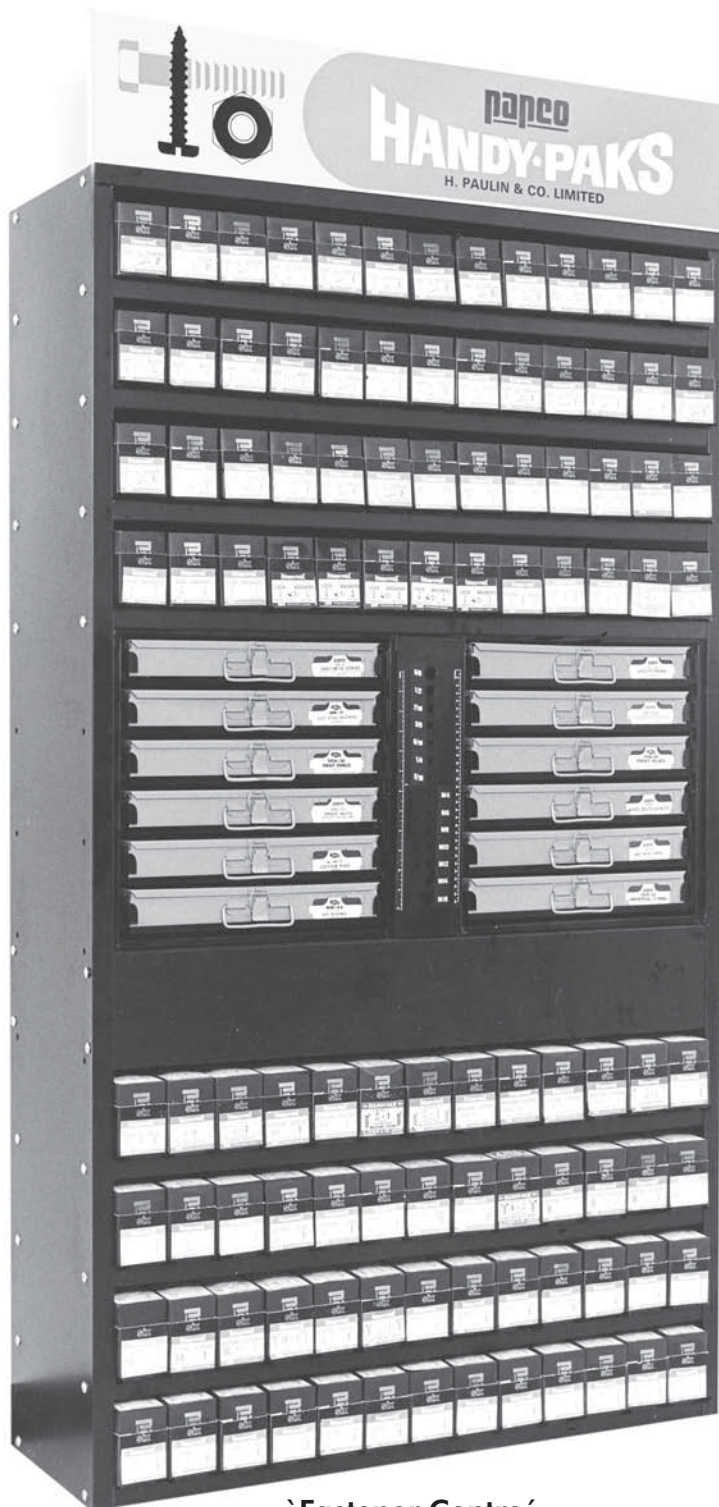

**‘Fastener Centre’
Merchandiser No. 022-075
(Complete as illustrated)**

The ‘Papco’ Fastener Centre enables every Jobber to carry the widest possible coverage of bolts, nuts and screws for the lowest possible investment.

Included are 312 Handy-Paks (104 items with a Starter Stock of 3 paks per item) of Grade 5 Cap Screws, Hex Nuts, Flat Washers, Lock Washers, Tapping Screws, Machine Screws, Stove Bolts and Cotter Pins - plus 12 Master Assortments (240 coin-drawer compartments) of replacement parts such as Wheel Bolts, Frost Plugs, Woodruff Keys, O-Rings, Spring Pins and more.

Each durable, long lasting merchandiser is of all-steel construction with a baked-on, black enamel finish and features two built-in Stax-Six cabinets with master assortments that slide out for easy access. A handy bolt measuring gauge in both inch and metric sizes and an attractive, three-colour sign are also included.

The complete ‘Fastener Centre’ - designed to save time, improve efficiency and increase profits.

For complete list of contents of Merchandiser No. 022-075 see reverse side.

MERCHANDISER No. 022-075 CONTENTS



| UNC GRADE 5 HEXAGON HEAD CAP SCREW | | | | | |
|---|----------------|--------------|----------------|---------------|----------------|
| Size | Handy-Pak No. | Size | Handy-Pak No. | Size | Handy-Pak No. |
| 1/4 x 3/4 | 023-003 | 5/16 x 2 | 023-022 | 7/16 x 1 | 023-042 |
| 1/4 x 1 | 023-005 | 5/16 x 2-1/2 | 023-024 | 7/16 x 1-1/2 | 023-044 |
| 1/4 x 1-1/2 | 023-007 | | | 7/16 x 2 | 023-046 |
| 1/4 x 2 | 023-009 | 3/8 x 1 | 023-031 | | |
| | | 3/8 x 1-1/4 | 023-032 | 1/2 x 1-1/2 | 023-055 |
| 5/16 x 1/2 | 023-014 | 3/8 x 1-1/2 | 023-033 | 1/2 x 2 | 023-057 |
| 5/16 x 3/4 | 023-016 | 3/8 x 2 | 023-035 | 1/2 x 3 | 023-060 |
| 5/16 x 1 | 023-018 | 3/8 x 2-1/2 | 023-037 | | |
| 5/16 x 1-1/2 | 023-020 | 3/8 x 3 | 023-038 | | |
| UNF GRADE 5 HEXAGON HEAD CAP SCREW | | | | | |
| Size | Handy-Pak No. | Size | Handy-Pak No. | Size | Handy-Pak No. |
| 1/4 x 1 | 023-105 | 5/16 x 1-1/2 | 023-120 | 3/8 x 1-1/2 | 023-133 |
| 1/4 x 1-1/2 | 023-107 | 5/16 x 2 | 023-122 | 3/8 x 2 | 023-135 |
| 5/16 x 3/4 | 023-116 | 3/8 x 1 | 023-131 | 1/2 x 1-1/2 | 023-155 |
| 5/16 x 1 | 023-118 | 3/8 x 1-1/4 | 023-132 | 1/2 x 2 | 023-157 |
| UNC HEXAGON NUTS PLATED | | | | | |
| Size | Handy-Pak No. | Size | Handy-Pak No. | Size | Handy-Pak No. |
| 1/4 | 023-201 | 3/8 | 023-203 | 1/2 | 023-205 |
| 5/16 | 023-202 | 7/16 | 023-204 | | |
| UNF HEXAGON NUTS PLATED | | | | | |
| Size | Handy-Pak No. | Size | Handy-Pak No. | Size | Handy-Pak No. |
| 1/4 | 023-221 | 3/8 | 023-223 | 1/2 | 023-225 |
| 5/16 | 023-222 | 7/16 | 023-224 | | |
| FLAT WASHERS PLATED | | | | | |
| Size | Handy-Pak No. | Size | Handy-Pak No. | Size | Handy-Pak No. |
| 3/16 | 023-302 | 5/16 | 023-304 | 7/16 | 023-306 |
| 1/4 | 023-303 | 3/8 | 023-305 | 1/2 | 023-307 |
| LOCK WASHERS PLATED | | | | | |
| Size | Handy-Pak No. | Size | Handy-Pak No. | Size | Handy-Pak No. |
| 3/16 | 023-342 | 5/16 | 023-344 | 7/16 | 023-346 |
| 1/4 | 023-343 | 3/8 | 023-345 | 1/2 | 023-347 |
| ROUND HEAD (SOCKET) MACHINE SCREWS | | | | | |
| Size | Handy-Pak No. | Size | Handy-Pak No. | Size | Handy-Pak No. |
| 6-32 x 3/4 | 023-404 | 8-32 x 1 | 023-412 | 10-32 x 1-1/2 | 023-421 |
| 6-32 x 1 | 023-405 | 8-32 x 1-1/2 | 023-414 | 1/4 x 3/4 | 023-424 |
| 6-32 x 1-1/2 | 023-407 | 10-32 x 3/4 | 023-418 | 1/4 x 1 | 023-425 |
| 8-32 x 3/4 | 023-411 | 10-32 x 1 | 023-419 | | |
| HEXAGON MACHINE NUTS | | | | | |
| Size | Handy-Pak No. | Size | Handy-Pak No. | Size | Handy-Pak No. |
| 6-32 | 023-460 | 8-32 | 023-461 | 10-32 | 023-462 |
| ROUND HEAD STOVE BOLTS | | | | | |
| Size | Handy-Pak No. | Size | Handy-Pak No. | Size | Handy-Pak No. |
| 3/16 x 3/4 | 023-502 | 3/16 x 2 | 023-507 | 1/4 x 1-1/2 | 023-514 |
| 3/16 x 1 | 023-503 | 1/4 x 3/4 | 023-511 | 1/4 x 2 | 023-516 |
| 3/16 x 1-1/2 | 023-505 | 1/4 x 1 | 023-512 | | |
| PAN HEAD (SOCKET) TAPPING SCREWS | | | | | |
| Size | Handy-Pak No. | Size | Handy-Pak No. | Size | Handy-Pak No. |
| 4 x 1/2 | 023-602 | 8 x 1/2 | 023-612 | 10 x 3/4 | 023-619 |
| 6 x 1/2 | 023-605 | 8 x 3/4 | 023-614 | 10 x 1 | 023-621 |
| 6 x 3/4 | 023-607 | 8 x 1 | 023-616 | 14 x 1 | 023-629 |
| HEXAGON HEAD TAPPING SCREWS | | | | | |
| Size | Handy-Pak No. | Size | Handy-Pak No. | Size | Handy-Pak No. |
| 8 x 1/2 | 023-665 | 5/16 x 1 | 023-677 | | |
| 10 x 3/4 | 023-669 | 3/8 x 1 | 023-679 | | |
| OVAL PHILLIPS SMALL TAPPING SCREWS | | | | | |
| Size | Handy-Pak No. | Size | Handy-Pak No. | Size | Handy-Pak No. |
| 8 x 1/2 | 023-685 | 8 x 3/4 | 023-687 | 8 x 1 | 023-689 |
| OVAL PHILLIPS REGULAR TAPPING SCREWS | | | | | |
| Size | Handy-Pak No. | Size | Handy-Pak No. | Size | Handy-Pak No. |
| 6 x 3/4 | 023-637 | | | | |
| COTTER PINS | | | | | |
| Size | Handy-Pak No. | Size | Handy-Pak No. | Size | Handy-Pak No. |
| 1/16 x 3/4 | 023-702 | 3-32 x 3/4 | 023-708 | 1/8 x 1 | 023-715 |
| 1/16 x 1 | 023-703 | 3-32 x 1 | 023-709 | 1/8 x 1-1/2 | 023-717 |
| 1/16 x 1-1/2 | 023-705 | 3-32 x 1-1/2 | 023-711 | 1/8 x 2 | 023-718 |

MASTER ASSORTMENTS (Includes 2 Stax-Six Cabinets)

| New Stock No. | Description | New Stock No. | Description | New Stock No. | Description |
|----------------|---------------|----------------|-------------------|----------------|---------------------|
| 020-614 | Woodruff Keys | 020-635 | Drain Plugs | 020-643 | Speed Nuts |
| 020-626 | 'O' Rings | 020-637 | Utility Springs | 020-658 | Wheel Parts |
| 020-627 | Snap Rings | 020-640 | Frost Plugs (Cup) | 020-725 | Metric Bolts & Nuts |
| 020-633 | Frost Plugs | 020-642 | Spring Pins | 020-726 | Metric Bolts & Nuts |

Note: Fastener Centre Conversion Kit No. 022-076 :
Includes two empty Stax-Six cabinets, Shelf and Bolt Gauge - for converting existing 022-067 Merchandiser.



Papco 'HANDY-PAK' MERCHANDISERS PRESENTOIRS 'HANDY-PAK'

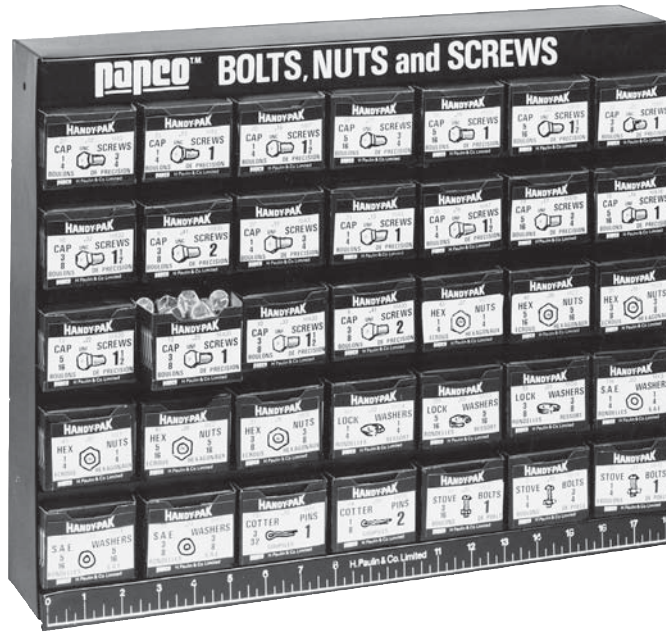

- Sturdy, Heavy Gauge, Reinforced Steel
- Use on Work Bench or Hang on Wall
- Colourful - Durable - Efficient
- Retail Prices on each Pak - Fastener Fact Chart
- Handy Bolt measuring Gauge Included.
- Inventory Control Strips

18-1/2" wide and 14-3/4" high

Note: Empty metal Merchandiser Rack No. 022-070 available to make up your own Merchandiser of any 35 'Papco' Handy-Paks.

| PLATED FASTENERS MERCHANDISER No. 022-061 | | | | | | | | | | | |
|---|---------|--------------|-----------------|---------|------|-----------------------|------|------|--------------------|-----------|------|
| Part No. | | Size | Part No. | | Size | Part No. | | Size | Part No. | | Size |
| Plated Grade 5 Cap Screws | | | Hex Nuts | | | Lock Washers | | | Cotter Pins | | |
| UNC | UNF | | UNC | UNF | | | | | | | |
| 023-003 | 023-103 | 1/4 x 3/4 | 023-201 | 023-221 | 1/4 | 023-343 | 1/4 | | 023-709 | 3/32 x 1 | |
| 023-005 | 023-105 | 1/4 x 1 | 023-202 | 023-222 | 5/16 | 023-344 | 5/16 | | 023-718 | 1/8 x 2 | |
| 023-007 | 023-107 | 1/4 x 1-1/2 | 023-203 | 023-223 | 3/8 | 023-345 | 3/8 | | Stove Bolts | | |
| 023-016 | 023-116 | 5/16 x 3/4 | | | | S.A.E. Washers | | | 023-503 | 3/16 x 1 | |
| 023-020 | 023-120 | 5/16 x 1-1/2 | | | | 023-323 | 1/4 | | 023-511 | 1/4 x 3/4 | |
| 023-031 | 023-131 | 3/8 x 1 | | | | 023-324 | 5/16 | | 023-512 | 1/4 x 1 | |
| 023-033 | 023-133 | 3/8 x 1-1/2 | | | | 023-325 | 3/8 | | | | |
| 023-035 | 023-135 | 3/8 x 2 | | | | | | | | | |

| PLATED BODYSHOP FASTENERS MERCHANDISER No. 022-063 | | | | | | | | | | | |
|--|----------|------|---------------------------------|----------|------|--|------------|------|----------------------------------|------------|------|
| Part No. | | Size | Part No. | | Size | Part No. | | Size | Part No. | | Size |
| Tapping Screws Pan Head | | | Tapping Screws Oval Head | | | Tapping Screws Oval Phillips Head | | | Machine Screws Round Head | | |
| 023-604 | 6 x 3/8 | | 023-635 | 6 x 1/2 | | 023-696 | 6 x 3/4 | | 023-412 | 8-32 x 1 | |
| 023-605 | 6 x 1/2 | | 023-644 | 8 x 3/4 | | 023-687 | 8 x 3/4 | | 023-419 | 10-32 x 1 | |
| 023-612 | 8 x 1/2 | | 023-649 | 10 x 3/4 | | 023-692 | 8 x 1-1/2 | | Machine Screws Oval Head | | |
| 023-614 | 8 x 3/4 | | Tapping Screws Hex Head | | | Machine Screws Round Head | | | 023-433 | 6-32 x 1/2 | |
| 023-618 | 10 x 1/2 | | 023-665 | 8 x 1/2 | | 023-403 | 6-32 x 1/2 | | 023-440 | 8-32 x 1/2 | |
| 023-619 | 10 x 3/4 | | 023-668 | 10 x 5/8 | | 023-405 | 6-32 x 1 | | 023-442 | 8-32 x 1 | |
| 023-621 | 10 x 1 | | 023-673 | 14 x 3/4 | | 023-410 | 8-32 x 1/2 | | 023-449 | 10-32 x 1 | |
| 023-629 | 14 x 1 | | 023-675 | 14 x 1 | | | | | Fender Washers | | |
| | | | 023-677 | 5/16 x 1 | | | | | 023-395 | 1/4 | |
| | | | | | | | | | 023-396 | 5/16 | |
| | | | | | | | | | 023-397 | 5/16L | |

| PLATED CAP SCREWS and NUT MERCHANDISER No. 022-064 | | | | | | | | | |
|--|---------|--------------|----------------------------------|---------|--------------|-----------------|---------|------|--|
| Part No. | | Size | Part No. | | Size | Part No. | | Size | |
| Plated Grade 5 Cap Screws | | | Plated Grade 5 Cap Screws | | | Hex Nuts | | | |
| UNC | UNF | | UNC | UNF | | UNC | UNF | | |
| 023-003 | 023-103 | 1/4 x 3/4 | 023-035 | 023-135 | 3/8 x 2 | 023-201 | 023-221 | 1/4 | |
| 023-005 | 023-105 | 1/4 x 1 | 023-044 | 023-144 | 7/16 x 1-1/2 | 023-202 | 023-222 | 5/16 | |
| 023-007 | 023-107 | 1/4 x 1-1/2 | 023-055 | 023-155 | 1/2 x 1-1/2 | 023-203 | 023-223 | 3/8 | |
| 023-016 | 023-116 | 5/16 x 3/4 | 023-057 | 023-157 | 1/2 x 2 | 023-204 | 023-224 | 7/16 | |
| 023-018 | 023-118 | 5/16 x 1 | 023-059 | 023-159 | 1/2 x 2-1/2 | 023-205 | 023-225 | 1/2 | |
| 023-020 | 023-120 | 5/16 x 1-1/2 | | | | | | | |
| 023-031 | 023-131 | 3/8 x 1 | | | | | | | |
| 023-033 | 023-133 | 3/8 x 1-1/2 | | | | | | | |

For complete listing of 'METRIC' Handy-Pak's see pages 22 to 23.



023
Series

papco HANDY-PAKS



"Papco" Handy-Paks contain Grade 5 Medium Carbon Heat Treated Cap Screws. The higher strength and toughness of these fasteners is needed in vehicle repair work. All Handy-Paks are Bright Plated for improved rust resistance and longer life.

Order By Stock Number

| GRADE 5 | | | HEXAGON HEAD CAP SCREWS | | | DOUBLE HEAT TREATED | | |
|-------------------------------|---------------|-------------|-------------------------|---------------|-------------|---------------------|---------------|-------------|
| SIZE | Coarse Thread | Fine Thread | SIZE | Coarse Thread | Fine Thread | SIZE | Coarse Thread | Fine Thread |
| 1/4 x 1/2 | 023-001 | 023-101 | 5/16 x 2 | 023-022 | 023-122 | 7/16 x 1-3/4 | 023-045 | 023-145 |
| 1/4 x 3/4 | 023-003 | 023-103 | 5/16 x 2-1/2 | 023-024 | 023-124 | 7/16 x 2 | 023-046 | 023-146 |
| 1/4 x 1 | 023-005 | 023-105 | 5/16 x 3 | 023-025 | 023-125 | 7/16 x 2-1/2 | 023-048 | 023-148 |
| 1/4 x 1-1/4 | 023-006 | 023-106 | | | | 7/16 x 3 | 023-049 | 023-149 |
| 1/4 x 1-1/2 | 023-007 | 023-107 | 3/8 x 3/4 | 023-029 | 023-129 | | | |
| 1/4 x 1-3/4 | 023-008 | 023-108 | 3/8 x 1 | 023-031 | 023-131 | 1/2 x 1 | 023-053 | 023-153 |
| 1/4 x 2 | 023-009 | 023-109 | 3/8 x 1-1/4 | 023-032 | 023-132 | 1/2 x 1-1/4 | 023-054 | 023-154 |
| 1/4 x 2-1/2 | 023-011 | 023-111 | 3/8 x 1-1/2 | 023-033 | 023-133 | 1/2 x 1-1/2 | 023-055 | 023-155 |
| 1/4 x 3 | 023-012 | 023-112 | 3/8 x 1-3/4 | 023-034 | 023-134 | 1/2 x 1-3/4 | 023-056 | 023-156 |
| | | | 3/8 x 2 | 023-035 | 023-135 | 1/2 x 2 | 023-057 | 023-157 |
| 5/16 x 1/2 | 023-014 | 023-114 | 3/8 x 2-1/2 | 023-037 | 023-137 | 1/2 x 2-1/2 | 023-059 | 023-159 |
| 5/16 x 3/4 | 023-016 | 023-116 | 3/8 x 3 | 023-038 | 023-138 | 1/2 x 3 | 023-160 | 023-160 |
| 5/16 x 1 | 023-018 | 023-118 | | | | | | |
| 5/16 x 1-1/4 | 023-019 | 023-119 | 7/16 x 1 | 023-042 | 023-142 | 5/8 x 1-1/2 | 023-074 | 023-174 |
| 5/16 x 1-1/2 | 023-020 | 023-120 | 7/16 x 1-1/4 | 023-043 | 023-143 | 5/8 x 2 | 023-076 | 023-176 |
| 5/16 x 1-3/4 | 023-021 | 023-121 | 7/16 x 1-1/2 | 023-044 | 023-144 | 5/8 x 2-1/2 | 023-078 | 023-178 |
| HEXAGON NUTS | | | POZI-LOK' STOP | | | WING NUTS | | |
| FINISHED | | | UNC Coarse Thread | | | | | |
| SIZE | Coarse Thread | Fine Thread | SIZE | Coarse Thread | Fine Thread | SIZE | HANDY-PAK NO. | |
| 1/4 | 023-201 | 023-221 | 1/4 | 023-204 | 023-224 | 1/4-20 | 023-264 | |
| 5/16 | 023-202 | 023-222 | 5/16 | 023-205 | 023-225 | 5/16-18 | 023-265 | |
| 3/8 | 023-203 | 023-223 | 3/8 | 023-206 | 023-226 | 3/8-16 | 023-266 | |
| 7/16 | 023-204 | 023-224 | 7/16 | 023-207 | 023-227 | | | |
| 1/2 | 023-205 | 023-225 | 1/2 | 023-208 | 023-228 | | | |
| 9/16 | 023-206 | 023-226 | | | | | | |
| 5/8 | 023-207 | 023-227 | | | | | | |
| 3/4 | 023-208 | 023-228 | | | | | | |
| PLAIN STEEL WASHERS | | | | | | | | |
| SIZE | HANDY-PAK NO. | | SIZE | HANDY-PAK NO. | | SIZE | HANDY-PAK NO. | |
| 3/16 | 023-302 | | 3/8 | 023-305 | | 9/16 | 023-308 | |
| 1/4 | 023-303 | | 7/16 | 023-306 | | 5/8 | 023-309 | |
| 5/16 | 023-304 | | 1/2 | 023-307 | | 3/4 | 023-310 | |
| S A E WASHERS | | | | | | | | |
| 3/16 | 023-322 | | 3/8 | 023-325 | | 9/16 | 023-328 | |
| 1/4 | 023-323 | | 7/16 | 023-326 | | 5/8 | 023-329 | |
| 5/16 | 023-324 | | 1/2 | 023-327 | | 3/4 | 023-330 | |
| SPRING LOCK WASHERS | | | | | | | | |
| 3/16 | 023-342 | | 3/8 | 023-345 | | 9/16 | 023-348 | |
| 1/4 | 023-343 | | 7/16 | 023-346 | | 5/8 | 023-349 | |
| 5/16 | 023-344 | | 1/2 | 023-347 | | 3/4 | 023-350 | |
| COUNTERSUNK FINISHING WASHERS | | | | | | | | |
| # 6 | 023-381 | | # 8 | 023-385 | | 1/4 | 023-389 | |
| # 8 | 023-383 | | | | | | | |
| FENDER WASHERS | | | | | | | | |
| 1/4 x 1-1/4 O.D. | 023-395 | | # 8 | 023-397 | | 1/4 | 023-398 | |
| # 8 | 023-396 | | | | | | | |

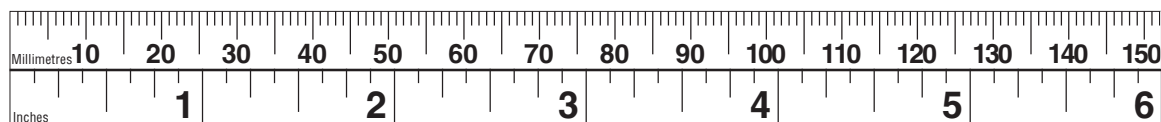



023
Series

papeo HANDY-PAKS (cont'd)



| ROUND HEAD — | | | MACHINE SCREWS AND NUTS | | | — OVAL HEAD | | |
|-------------------------------|---------------------|---------|-------------------------|---------------------|---------|----------------------|-----------------------|---------|
| SIZE | ROUND | OVAL | SIZE | ROUND | OVAL | SIZE | ROUND | OVAL |
| 6-32 x 1/2 | 023-403 | 023-433 | 8-32 x 1 | 023-412 | 023-442 | 1/4-20 x 3/4 | 023-424 | |
| 6-32 x 3/4 | 023-404 | | 8-32 x 1-1/2 | 023-414 | 023-444 | 1/4-20 x 1 | 023-425 | 023-455 |
| 6-32 x 1 | 023-405 | 023-435 | 10-32 x 1/2 | 023-417 | 023-447 | HEXAGON NUTS | | |
| 6-32 x 1-1/4 | 023-406 | | 10-32 x 3/4 | 023-418 | 023-448 | HANDY-PAK NO. | | |
| 6-32 x 1-1/2 | 023-407 | | 10-32 x 1 | 023-419 | 023-449 | 6-32 | 023-460 | |
| 8-32 x 3/8 | 023-409 | 023-439 | 10-32 x 1-1/4 | 023-420 | | 8-32 | 023-461 | |
| 8-32 x 1/2 | 023-410 | 023-440 | 10-32 x 1-1/2 | 023-421 | 023-451 | 10-32 | 023-462 | |
| 8-32 x 3/4 | 023-411 | 023-441 | | | | 1/4-20 | 023-464 | |
| ROUND HEAD STOVE BOLTS | | | | | | | | |
| SIZE | HANDY-PAK NO. | | SIZE | HANDY-PAK NO. | | SIZE | HANDY-PAK NO. | |
| 3/16 x 1/2 | 023-501 | | 3/16 x 1-1/2 | 023-505 | | 1/4 x 1 | 023-512 | |
| 3/16 x 3/4 | 023-502 | | 3/16 x 2 | 023-507 | | 1/4 x 1-1/4 | 023-513 | |
| 3/16 x 1 | 023-503 | | 1/4 x 1/2 | 023-510 | | 1/4 x 1-1/2 | 023-514 | |
| 3/16 x 1-1/4 | 023-504 | | 1/4 x 3/4 | 023-511 | | 1/4 x 2 | 023-516 | |
| SHEET METAL SCREWS | | | | | | | | |
| PAN HEAD | | | OVAL HEAD | | | HEX HEAD | | |
| SIZE | PAN | OVAL | SIZE | PAN | OVAL | SIZE | HEX | |
| 4 x 1/2 | 023-602 | | 8 x 1 | 023-616 | 023-646 | 8 x 1/2 | 023-665 | |
| 6 x 3/8 | 023-604 | | 10 x 1/2 | 023-618 | 023-648 | 10 x 1/2 | 023-667 | |
| 6 x 1/2 | 023-605 | 023-635 | 10 x 3/4 | 023-619 | 023-649 | 10 x 5/8 | 023-668 | |
| 6 x 3/4 | 023-607 | 023-637 | 10 x 1 | 023-621 | 023-651 | 10 x 3/4 | 023-669 | |
| 6 x 1 | 023-609 | 023-639 | 10 x 1-1/4 | 023-622 | 023-652 | 14 x 1/2 | 023-671 | |
| 8 x 3/8 | 023-611 | | 14 x 3/4 | 023-628 | 023-658 | 14 x 3/4 | 023-673 | |
| 8 x 1/2 | 023-612 | 023-642 | 14 x 1 | 023-629 | 023-659 | 14 x 1 | 023-675 | |
| 8 x 3/4 | 023-614 | 023-644 | | | | 5/16 x 1 | 023-677 | |
| | | | | | | 3/8 x 1 | 023-679 | |
| SIZE | OVAL PHILLIPS SMALL | | SIZE | OVAL PHILLIPS SMALL | | SIZE | OVAL PHILLIPS REGULAR | |
| 8 x 1/2 | 023-685 | | 8 x 1-1/2 | 023-692 | | 6 x 3/4 | 023-696 | |
| 8 x 3/4 | 023-687 | | 10 x 1 | 023-694 | | 8 x 3/4 | 023-698 | |
| 8 x 1 | 023-689 | | | | | | | |
| COTTER PINS | | | | | | | | |
| SIZE | HANDY-PAK NO. | | SIZE | HANDY-PAK NO. | | SIZE | HANDY-PAK NO. | |
| 1/16 x 3/4 | 023-702 | | 3/32 x 1 | 023-709 | | 1/8 x 1-1/2 | 023-717 | |
| 1/16 x 1 | 023-703 | | 3/32 x 1-1/4 | 023-710 | | 1/8 x 2 | 023-718 | |
| 1/16 x 1-1/2 | 023-705 | | 3/32 x 1-1/2 | 023-711 | | 5/32 x 1-1/2 | 023-722 | |
| 3/32 x 1/2 | 023-707 | | 1/8 x 1 | 023-715 | | 5/32 x 2 | 023-723 | |
| 3/32 x 3/4 | 023-708 | | 1/8 x 1-1/4 | 023-716 | | | | |

Note: Handy-Pak contents are based on Dealer Prices currently in effect and are subject to change.

INVERTED DRAWER BOX

- Upside-down Design Converts to Double Strength Drawer.
- Drawer Pull for Easy Access.
- Heavy Weight Fibreboard.



Convenient SIX-PAK trays.

025 Series

MEGAPAK™

More pieces per pack than Handy-Paks!

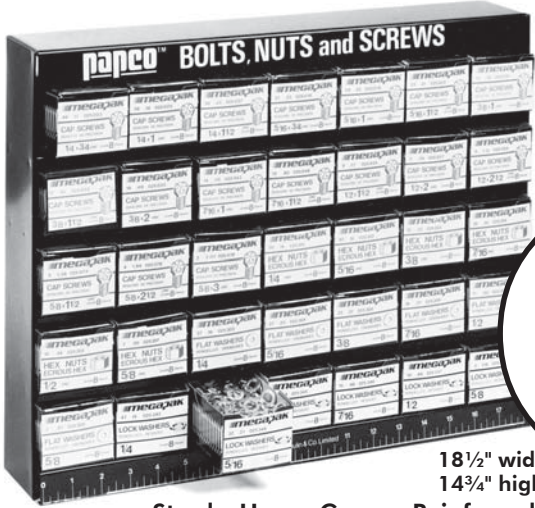

18 1/2" wide
14 3/4" high

'Papco' Mega-Paks™ are uniformly priced packages of the most popular High Strength Grade 8 Fasteners in both UNC Coarse and UNF Fine Thread, Stainless Steel, Marine Fasteners plus Wheel Bolts and Nuts. Each Mega-Pak™ features a larger quantity than standard Handy-Paks™, illustrated colour-coded

labels and a double strength drawer box conveniently packed in Six-Pak trays.

'Papco' Mega-Paks™ are available individually or in factory prepared Merchandisers containing 35 sizes of the fastest moving sizes of High Strength Grade 8 Fasteners, Marine Fasteners and Wheel Parts.

- Sturdy, Heavy Gauge, Reinforced Steel Cabinet
- Use on Work Bench or Hang on Wall
- Colourful-Durable-Efficient
- Includes handy Bolt measuring Gauge

| UNF PLATED GRADE 8 FASTENER MERCHANDISER No. 022-059 | | | | | | | | | |
|--|---------------|-----------------------------|---------------|----------------------|---------|-------------------------|------|----------------------|------|
| Part No. | Size | Part No. | Size | Part No. | Size | Part No. | Size | Part No. | Size |
| UNF Plated Gr. 8 Cap Screws | | UNF Plated Gr. 8 Cap Screws | | UNF Grade 8 Hex Nuts | | GRADE 8 Tension Washers | | GRADE 8 Lock Washers | |
| 025-103 | 1/4-28x3/4 | 025-142 | 7/16-20x1 | 025-221 | 1/4-28 | 025-303 | 1/4 | 025-343 | 1/4 |
| 025-105 | 1/4-28x1 | 025-144 | 7/16-20x1 1/2 | 025-222 | 5/16-24 | 025-304 | 5/16 | 025-344 | 5/16 |
| 025-107 | 1/4-28x1 1/2 | 025-155 | 1/2-20x1 1/2 | 025-223 | 3/8-24 | 025-305 | 3/8 | 025-345 | 3/8 |
| 025-116 | 5/16-24x3/4 | 025-157 | 1/2-20x2 | 025-224 | 7/16-20 | 025-306 | 7/16 | 025-346 | 7/16 |
| 025-118 | 5/16-24x1 | 025-159 | 1/2-20x2 1/2 | 025-225 | 1/2-20 | 025-307 | 1/2 | 025-347 | 1/2 |
| 025-120 | 5/16-24x1 1/2 | 025-174 | 5/8-18x1 1/2 | 025-227 | 5/8-18 | 025-309 | 5/8 | 025-349 | 5/8 |
| 025-131 | 3/8-24x1 | 025-176 | 5/8-18x2 | | | | | | |
| 025-133 | 3/8-24x1 1/2 | 025-178 | 5/8-18x2 1/2 | | | | | | |
| 025-135 | 3/8-24x2 | | | | | | | | |

| UNC PLATED GRADE 8 FASTENER MERCHANDISER No. 022-060 | | | | | | | | | |
|--|---------------|-----------------------------|---------------|----------------------|---------|-------------------------|------|----------------------|------|
| Part No. | Size | Part No. | Size | Part No. | Size | Part No. | Size | Part No. | Size |
| UNC Plated Gr. 8 Cap Screws | | UNC Plated Gr. 8 Cap Screws | | UNC Grade 8 Hex Nuts | | GRADE 8 Tension Washers | | GRADE 8 Lock Washers | |
| 025-003 | 1/4-20x3/4 | 025-042 | 7/16-14x1 | 025-201 | 1/4-20 | 025-303 | 1/4 | 025-343 | 1/4 |
| 025-005 | 1/4-20x1 | 025-044 | 7/16-14x1 1/2 | 025-202 | 5/16-18 | 025-304 | 5/16 | 025-344 | 5/16 |
| 025-007 | 1/4-20x1 1/2 | 025-055 | 1/2-13x1 1/2 | 025-203 | 3/8-16 | 025-305 | 3/8 | 025-345 | 3/8 |
| 025-016 | 5/16-18x3/4 | 025-057 | 1/2-13x2 | 025-204 | 7/16-14 | 025-306 | 7/16 | 025-346 | 7/16 |
| 025-018 | 5/16-18x1 | 025-059 | 1/2-13x2 1/2 | 025-205 | 1/2-13 | 025-307 | 1/2 | 025-347 | 1/2 |
| 025-020 | 5/16-18x1 1/2 | 025-074 | 5/8-11x1 1/2 | 025-207 | 5/8-11 | 025-309 | 5/8 | 025-349 | 5/8 |
| 025-031 | 3/8-16x1 | 025-076 | 5/8-11x2 | | | | | | |
| 025-033 | 3/8-16x1 1/2 | 025-078 | 5/8-11x2 1/2 | | | | | | |
| 025-035 | 3/8-16x2 | | | | | | | | |

| UNC 18.8 STAINLESS STEEL BOLT AND NUT MERCHANDISER No. 022-057 | | | | | | | | | |
|--|-----------|-------------------------------|------------|-------------------------------|-----------|--|------|-------------------------------------|------------|
| Part No. | Size | Part No. | Size | Part No. | Size | Part No. | Size | Part No. | Size |
| UNC 18.8 St. Steel Cap Screws | | UNC 18.8 St. Steel Cap Screws | | UNC 18.8 St. Steel Cap Screws | | UNC 18.8 Stainless Steel Pozi-Lok Nuts | | 18.8 Stainless Steel Fender Washers | |
| 025-401 | 1/4x1/2 | 025-418 | 5/16x1 | 025-437 | 3/8x2 1/2 | 025-511 | 1/4 | 025-531 | 1/4 |
| 025-403 | 1/4x3/4 | 025-420 | 5/16x1 1/2 | 025-438 | 3/8x3 | 025-512 | 5/16 | 025-532 | 5/16 |
| 025-405 | 1/4x1 | 025-422 | 5/16x2 | 025-439 | 3/8x3 1/2 | 025-513 | 3/8 | 025-533 | 3/8 |
| 025-407 | 1/4x1 1/2 | 025-424 | 5/16x2 1/2 | UNC 18.8 St. Steel Hex Nuts | | 18.8 Stainless Steel Flat Washers | | 18.8 Stainless Steel Cotter Pins | |
| 025-409 | 1/4x2 | 025-429 | 3/8x3/4 | 025-501 | 1/4 | 025-521 | 1/4 | 025-541 | 3/32x1 1/2 |
| 025-411 | 1/4x2 1/2 | 025-431 | 3/8x1 | 025-502 | 5/16 | 025-522 | 5/16 | 025-542 | 3/32x2 |
| 025-414 | 5/16x1/2 | 025-433 | 3/8x1 1/2 | 025-503 | 3/8 | 025-523 | 3/8 | 025-548 | 1/8x2 |
| 025-416 | 5/16x3/4 | 025-435 | 3/8x2 | | | | | 025-551 | 1/8x3 |

| 18.8 STAINLESS STEEL SCREW MERCHANDISER No. 022-058 | | | | | | | | | |
|---|-------------|---|-------------|---|---------|---|----------|---|--------|
| Part No. | Size | Part No. | Size | Part No. | Size | Part No. | Size | Part No. | Size |
| 18.8 Stainless Steel Round Slot Machine Screws | | 18.8 Stainless Steel Oval Phillips Machine Screws | | 18.8 Stainless Steel Flat Socket Tapping Screws | | 18.8 Stainless Steel Flat Socket Tapping Screws | | 18.8 Stainless Steel Hex Machine Screw Nuts | |
| 025-613 | 10-24x1 | 025-620 | 10-24x1 | 025-651 | 6x3/4 | 025-660 | 12x1 1/2 | 025-700 | 10-24 |
| 025-614 | 10-24x1 1/2 | 025-621 | 10-24x1 1/4 | 025-652 | 6x1 | 025-661 | 12x2 | 025-701 | 1/4 |
| 025-615 | 10-24x2 | 025-622 | 10-24x1 1/2 | 025-653 | 8x3/4 | 025-662 | 12x2 1/2 | 18.8 Stainless Steel Finishing Washers | |
| 025-616 | 1/4x1 | 025-623 | 1/4x1 | 025-654 | 8x1 | 18.8 Stainless Steel Pan Socket Tapping Screws | | 025-706 | No. 6 |
| 025-617 | 1/4x1 1/2 | 025-624 | 1/4x1 1/2 | 025-655 | 8x1 1/4 | 025-674 | 8x1 | 025-708 | No. 8 |
| 025-618 | 1/4x2 | 025-625 | 1/4x2 | 025-656 | 8x1 1/2 | 025-676 | 8x1 1/2 | 025-709 | No. 10 |
| 025-619 | 1/4x2 1/2 | | | 025-657 | 10x11/4 | 025-678 | 10x11/2 | 025-710 | 1/4 |
| | | | | 025-658 | 10x11/2 | 025-679 | 10x2 | | |
| | | | | 025-659 | 10x2 | | | | |

For Wheel Parts Mega-Pak™ Merchandiser No. 022-056 see Wheel Parts page 154 or current Wheel parts catalogue.



Metric HANDY-PAKS



71" h. x 36-1/4" w. x 12" d. incl. sign

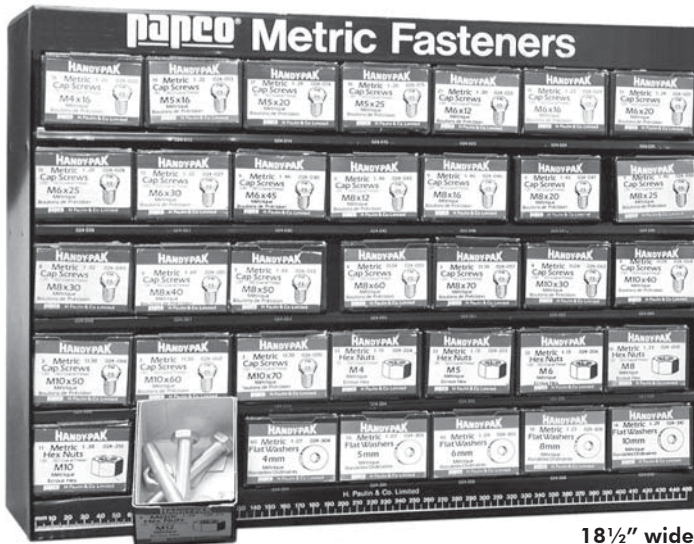

18 1/2" wide
14 3/4" high

UNIFORM PRICED PACKAGES OF METRIC FASTENERS

- All Bright Plated Material
- No Broken Boxes
- Good For Regular Stock
- Ideal For Assortment Refills
- Best Value
- Fully Illustrated, Colour-Coded Labels
- Five Shelf Empty Storage Area with Doors

'Papco' Handy-Paks are the most economical method of stocking Metric Fasteners. They contain the complete range of ISO Coarse, Fine and Extra Fine Cap Screws, Nuts and Washers. The available merchandiser is designed to provide maximum coverage for a minimum investment.



MASTER METRIC HANDY-PAK MERCHANDISER No. 022-068

Contains 273 Handy-Paks, 91 sizes of ISO Coarse, Fine and Extra Fine Cap Screws, Nuts and Washers plus rack, measuring gauge and sign.

- Sturdy, Heavy Gauge, Reinforced Steel Cabinet
- Use on Work Bench or Hang on Wall
- Colourful - Durable - Efficient
- Includes Handy Bolt Measuring Gauge and Inventory Control Strips

METRIC FINE THREAD MERCHANDISER No. 022-062

35 sizes of Metric Fine and Extra Fine Cap Screws, Nuts and Lock Washers.

METRIC ISO COARSE THREAD MERCHANDISER No. 022-065

35 best sizes of Metric Coarse Thread Cap Screws, Nuts and Washers.

PLATED METRIC FASTENERS MERCHANDISER No. 022-066

35 sizes of Metric Machine Screws, Lock Washers and Nuts, Spring Washers, Cotter Pins and Socket Screws. (see reverse side for contents)



| MERCHANDISER NO. 022-062 Contents | | | | | | | |
|-----------------------------------|--------|------------------------------|--------|------------------------------|----------|------------------------|----------|
| Part No. | Size | Part No. | Size | Part No. | Size | Part No. | Size |
| Fine Metric Cap Screws | | Fine Metric Cap Screws | | Extra Fine Metric Cap Screws | | Extra Fine Metric Nuts | |
| 024-120 | M8X20 | 024-138 | M10X60 | 024-174 | M10X40 | 024-270 | M10X1.00 |
| 024-122 | M8X30 | 024-144 | M12X30 | 024-176 | M10X50 | 024-272 | M12X1.25 |
| 024-124 | M8X40 | 024-146 | M12X40 | 024-184 | M12X30 | Metric Lock Washers | |
| 024-126 | M8X50 | 024-148 | M12X50 | 024-186 | M12X40 | 024-324 | 4mm |
| 024-130 | M10X20 | Extra Fine Metric Cap Screws | | 024-188 | M12X50 | 024-325 | 5mm |
| 024-131 | M10X25 | Extra Fine Metric Cap Screws | | Fine Metric Hex Nuts | | 024-326 | 6mm |
| 024-132 | M10X30 | 024-170 | M10X20 | 024-258 | M8X1.00 | 024-328 | 8mm |
| 024-134 | M10X40 | 024-171 | M10X25 | 024-260 | M10X1.25 | 024-330 | 10mm |
| 024-136 | M10X50 | 024-172 | M10X30 | 024-262 | M12X1.5 | 024-332 | 12mm |

| MERCHANDISER NO. 022-065 Contents | | | | | | | |
|-----------------------------------|-------|------------------------------|--------|------------------------------|--------|-----------------|------|
| Part No. | Size | Part No. | Size | Part No. | Size | Part No. | Size |
| ISO Coarse Metric Cap Screws | | ISO Coarse Metric Cap Screws | | ISO Coarse Metric Cap Screws | | Coarse Hex Nuts | |
| 024-002 | M4X16 | 024-045 | M8X12 | 024-064 | M10X40 | 024-204 | M4 |
| 024-013 | M5X16 | 024-046 | M8X16 | 024-066 | M10X50 | 024-205 | M5 |
| 024-014 | M5X20 | 024-047 | M8X20 | 024-068 | M10X60 | 024-206 | M6 |
| 024-015 | M5X25 | 024-048 | M8X25 | 024-070 | M10X70 | 024-208 | M8 |
| 024-023 | M6X12 | 024-049 | M8X30 | Metric Flat Washers | | 024-210 | M10 |
| 024-024 | M6X16 | 024-051 | M8X40 | 024-304 | 4mm | 024-212 | M12 |
| 024-025 | M6X20 | 024-053 | M8X50 | 024-305 | 5mm | | |
| 024-026 | M6X25 | 024-055 | M8X60 | 024-306 | 6mm | | |
| 024-027 | M6X30 | 024-057 | M8X70 | 024-308 | 8mm | | |
| 024-030 | M6X45 | 024-062 | M10X30 | 024-310 | 10mm | | |

| PLATED METRIC FASTENERS MERCHANDISER No. 022-066 | | | | | | | | | |
|--|-------|-----------------|------|---------------------|------|-----------------------|------|--------------------|--------|
| Part No. | Size | Part No. | Size | Part No. | Size | Part No. | Size | Part No. | Size |
| Metric Machine Screws | | Metric Locknuts | | Metric Lock Washers | | Metric Spring Washers | | Metric Cotter Pins | |
| 024-406 | M4X6 | 024-224 | M4 | 024-324 | 4mm | 024-344 | 4mm | 024-704 | 1.5X16 |
| 024-412 | M4X12 | 024-225 | M5 | 024-325 | 5mm | 024-345 | 5mm | 024-707 | 2X20 |
| 024-420 | M5X10 | 024-226 | M6 | 024-326 | 6mm | 024-346 | 6mm | 024-713 | 3X40 |
| 024-426 | M5X16 | 024-228 | M8 | 024-328 | 8mm | 024-348 | 8mm | 024-716 | 4X50 |
| 024-436 | M6X16 | 024-230 | M10 | 024-330 | 10mm | 024-350 | 10mm | 024-919 | M6X12 |
| 024-440 | M6X20 | | | | | | | 024-930 | M8X12 |
| | | | | | | | | 024-734 | 2X16 |
| | | | | | | | | 024-740 | 3X24 |
| | | | | | | | | 024-749 | 4X36 |
| | | | | | | | | 024-758 | 5X50 |
| | | | | | | | | 024-764 | 6X50 |

| MERCHANDISER NO. 022-068 Contents | | | | | | | |
|-----------------------------------|-------|------------------------------|--------|------------------------------|----------|----------------------------|----------|
| Part No. | Size | Part No. | Size | Part No. | Size | Part No. | Size |
| ISO Coarse Metric Cap Screws | | ISO Coarse Metric Cap Screws | | Fine Metric Cap Screws | | Extra Fine Metric Hex Nuts | |
| 024-002 | M4X16 | 024-060 | M10X20 | 024-144 | M12X30 | 024-270 | M10X1.00 |
| 024-004 | M4X25 | 024-061 | M10X25 | 024-146 | M12X40 | 024-272 | M12X1.25 |
| 024-012 | M5X12 | 024-062 | M10X30 | 024-148 | M12X50 | Metric Flat Washers | |
| 024-013 | M5X16 | 024-063 | M10X35 | Extra Fine Metric Cap Screws | | 024-304 | 4mm |
| 024-014 | M5X20 | 024-064 | M10X40 | 024-170 | M10X20 | 024-305 | 5mm |
| 024-015 | M5X25 | 024-066 | M10X50 | 024-171 | M10X25 | 024-306 | 6mm |
| 024-023 | M6X12 | 024-068 | M10X60 | 024-172 | M10X30 | 024-308 | 8mm |
| 024-024 | M6X16 | 024-070 | M10X70 | 024-174 | M10X40 | 024-310 | 10mm |
| 024-025 | M6X20 | 024-075 | M12X30 | 024-176 | M10X50 | 024-312 | 12mm |
| 024-026 | M6X25 | 024-077 | M12X40 | 024-176 | M10X50 | Metric Lock Washers | |
| 024-027 | M6X30 | 024-079 | M12X50 | 024-184 | M12X30 | 024-324 | 4mm |
| 024-028 | M6X35 | 024-081 | M12X60 | 024-186 | M12X40 | 024-325 | 5mm |
| 024-029 | M6X40 | 024-083 | M12X70 | 024-188 | M12X50 | 024-326 | 6mm |
| 024-030 | M6X45 | Fine Metric Cap Screws | | ISO Coarse Metric Hex Nuts | | 024-328 | 8mm |
| 024-031 | M6X50 | 024-120 | M8X20 | 024-204 | M4 | 024-330 | 10mm |
| 024-045 | M8X12 | 024-122 | M8X30 | 024-205 | M5 | 024-332 | 12mm |
| 024-046 | M8X16 | 024-124 | M8X40 | 024-206 | M6 | Metric Lock Nuts | |
| 024-047 | M8X20 | 024-126 | M8X50 | 024-208 | M8 | 024-224 | M4 |
| 024-048 | M8X25 | 024-130 | M10X20 | 024-210 | M10 | 024-226 | M6 |
| 024-049 | M8X30 | 024-131 | M10X25 | 024-212 | M12 | 024-228 | M8 |
| 024-050 | M8X35 | 024-132 | M10X30 | Fine Metric Hex Nuts | | 024-230 | M10 |
| 024-051 | M8X40 | 024-133 | M10X35 | 024-258 | M8X1.00 | Metric Machine Screws | |
| 024-052 | M8X45 | 024-134 | M10X40 | 024-260 | M10X1.25 | 024-430 | M6X10 |
| 024-053 | M8X50 | 024-136 | M10X50 | 024-262 | M12X1.5 | 024-436 | M6X16 |
| 024-055 | M8X60 | 024-138 | M10X60 | | | 024-440 | M6X20 |
| 024-057 | M8X70 | | | | | | |

Note: Metric Handy-Pak contents are based on Dealer prices currently in effect and are subject to change.



024
Series

papeo METRIC HANDY-PAKS

| CLASS 8.8 | | HEXAGON HEAD CAP SCREWS | | Regular ISO Coarse Thread Series | |
|---|---------------|---|---------------|---|---------------|
| Size | Handy-Pak No. | Size | Handy-Pak No. | Size | Handy-Pak No. |
| M4x16* | 024-002 | M8x12* | 024-045 | M10x35* | 024-063 |
| M4x25 | 024-004 | M8x16* | 024-046 | M10x40 | 024-064 |
| M5x12* | 024-012 | M8x20* | 024-047 | M10x50 | 024-066 |
| M5x16* | 024-013 | M8x25* | 024-048 | M10x60 | 024-068 |
| M5x20* | 024-014 | M8x30* | 024-049 | M10x70 | 024-070 |
| M5x25* | 024-015 | M8x35 | 024-050 | | |
| M6x12* | 024-023 | M8x40 | 024-051 | M12x30* | 024-075 |
| M6x16* | 024-024 | M8x45 | 024-052 | M12x40* | 024-077 |
| M6x20* | 024-025 | M8x50 | 024-053 | M12x50 | 024-079 |
| M6x25* | 024-026 | M8x60 | 024-055 | M12x60 | 024-081 |
| M6x30 | 024-027 | M8x70 | 024-057 | M12x70 | 024-083 |
| M6x35 | 024-028 | | | | |
| M6x40 | 024-029 | M10x20* | 024-060 | <i>Thread Length: Formula is 2D + 6mm. Items marked * are Fully Threaded.</i> | |
| M6x45 | 024-030 | M10x25* | 024-061 | | |
| M6x50 | 024-031 | M10x30* | 024-062 | | |
| CLASS 8 | | HEXAGON NUTS | | Regular ISO Coarse Thread Series | |
| M4 | 024-204 | M6 | 024-206 | M10 | 024-210 |
| M5 | 024-205 | M8 | 024-208 | M12 | 024-212 |
| CLASS 8.8 | | FINE THREAD HEXAGON HEAD CAP SCREWS | | | |
| M8x1.0x20* | 024-120 | M10x1.25x25* | 024-131 | M10x1.25x60 | 024-138 |
| M8x1.0x30* | 024-122 | M10x1.25x30* | 024-132 | M12x1.5x30* | 024-144 |
| M8x1.0x40* | 024-124 | M10x1.25x35* | 024-133 | M12x1.5x40* | 024-146 |
| M8x1.0x50* | 024-126 | M10x1.25x40* | 024-134 | M12x1.5x50* | 024-148 |
| M10x1.25x20* | 024-130 | M10x1.25x50* | 024-136 | | |
| CLASS 8.8 | | EXTRA FINE THREAD HEXAGON HEAD CAP SCREWS | | | |
| M10x1.0x20* | 024-170 | M10x1.0x40* | 024-174 | M12x1.25x40* | 024-186 |
| M10x1.0x25* | 024-171 | M10x1.0x50* | 024-176 | M12x1.25x50* | 024-188 |
| M10x1.0x30* | 024-172 | M12x1.25x30* | 024-184 | | |
| CLASS 8 | | FINE and EXTRA FINE THREAD HEXAGON NUTS | | | |
| M8x1.0 | 024-258 | M12x1.5 | 024-262 | M10x1.0 | 024-270 |
| M10x1.25 | 024-260 | | | M12x1.25 | 024-272 |
| NYLON COLLAR STOP NUTS | | ‘POZI-LOK’ NUTS | | Regular ISO Coarse Thread Series | |
| M4 | 024-224 | M6 | 024-226 | M10 | 024-230 |
| M5 | 024-225 | M8 | 024-228 | | |
| FLAT WASHERS | | | | | |
| 4mm | 024-304 | 6mm | 024-306 | 10mm | 024-310 |
| 5mm | 024-305 | 8mm | 024-308 | 12mm | 024-312 |
| LOCK WASHERS | | | | | |
| 4mm | 024-324 | 6mm | 024-326 | 10mm | 024-330 |
| 5mm | 024-325 | 8mm | 024-328 | 12mm | 024-332 |
| SPRING (wave type) WASHERS (PLAIN FINISH) | | | | | |
| 4mm | 024-344 | 6mm | 024-346 | 10mm | 024-350 |
| 5mm | 024-345 | 8mm | 024-348 | | |
| MACHINE SCREWS Pan Slot Head | | | | | |
| M4x6 | 024-406 | M5x10 | 024-420 | M6x10 | 024-430 |
| M4x12 | 024-412 | M5x16 | 024-426 | M6x16 | 024-436 |
| | | | | M6x20 | 024-440 |
| COTTER PINS | | | | | |
| M1.5x16 | 024-704 | M3x25 | 024-710 | M4x50 | 024-716 |
| M2.0x20 | 024-707 | M3x40 | 024-713 | | |
| SLOTTED SPRING PINS (PLAIN FINISH) | | | | | |
| M2.0x16 | 024-734 | M4x18 | 024-746 | M5x50 | 024-758 |
| M2.5x18 | 024-737 | M4x36 | 024-749 | M6x22 | 024-761 |
| M3.0x24 | 024-740 | M4x50 | 024-752 | M6x50 | 024-764 |
| M3.0x40 | 024-743 | M5x36 | 024-755 | | |
| SOCKET SET SCREWS with keys | | | | ALLOY STEEL | |
| M4x5 | 024-904 | M6x8 | 024-916 | M8x8 | 024-926 |
| M4x10 | 024-907 | M6x12 | 024-919 | M8x12 | 024-930 |
| M5x10 | 024-910 | M6x20 | 024-922 | M8x20 | 024-934 |
| M5x16 | 024-913 | | | | |
| SOCKET SCREW KEYS | | | | (PLAIN FINISH) | |
| 1.5mm | 024-980 | 3mm | 024-983 | 6mm | 024-986 |
| 2.0mm | 024-981 | 4mm | 024-984 | 8mm | 024-988 |
| 2.5mm | 024-982 | 5mm | 024-985 | | |

608's
Series



METRIC HEX HEAD CAP SCREWS
BOULONS DE PRECISION METRIQUE



High Tensile Screws made to ISO-Metric Specifications.
Property Class: 8.8 (nominal tensile strength 800 MPa or about 118,000 p.s.i., similar to SAE Grade 5)

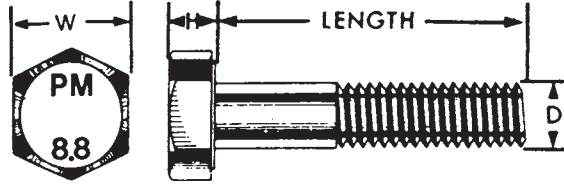

Heat Treated Steel

ZINC CHROMATE PLATED
REGULAR ISO COARSE THREAD SERIES

| Dia.(D) | M4 | M5 | M6 | M7 | M8 | M10 | M12 | M14 | M16 | M18 | M20 | M24 |
|-----------|----------|----------|----------|-------|----------|----------|----------|----------|----------|----------|----------|----------|
| Inch Size | .157" | .197" | .236" | .276" | .315" | .394" | .472" | .551" | .630" | .709" | .787" | .944" |
| A.F. (W) | 7 | 8 | 10 | 11 | 13 | 17 | 19 | 22 | 24 | 27 | 30 | 36 |
| Hght. (H) | 2.8 | 3.5 | 4.0 | 5.5 | 5.5 | 7.0 | 8.0 | 9.0 | 10.0 | 12.0 | 13.0 | 15.0 |
| Pitch(mm) | .70 | .80 | 1.00 | 1.00 | 1.25 | 1.50 | 1.75 | 2.00 | 2.00 | 2.50 | 2.50 | 3.00 |
| Length | | | | | | | | | | | | |
| 12 mm | - | 608-198* | 608-267* | - | 608-311* | - | - | - | - | - | - | - |
| 16 mm | 608-139* | 608-201* | 608-270* | - | 608-314* | 608-364* | - | - | - | - | - | - |
| 20 mm | 608-141* | 608-203* | 608-272* | - | 608-316* | 608-366* | - | - | - | - | - | - |
| 25 mm | 608-143* | 608-205* | 608-274* | - | 608-318* | 608-368* | 608-412* | 608-436* | 608-462* | - | - | - |
| 30 mm | - | - | 608-276 | - | 608-320* | 608-370* | 608-414* | 608-438* | 608-464* | - | - | - |
| 35 mm | - | - | 608-277 | - | 608-321 | 608-371* | 608-415* | - | 608-465* | - | - | - |
| 40 mm | - | - | 608-278 | - | 608-322 | 608-372 | 608-416* | 608-440* | 608-466* | 608-500* | 608-520* | - |
| 45 mm | - | - | 608-279 | - | 608-323 | 608-373 | 608-417 | - | 608-467 | - | - | - |
| 50 mm | - | - | 608-280 | - | 608-324 | 608-374 | 608-418 | 608-442 | 608-468 | 608-502* | 608-522* | 608-552* |
| 60 mm | - | - | - | - | 608-326 | 608-376 | 608-420 | 608-444 | 608-470 | 608-504 | 608-524* | 608-554* |
| 70 mm | - | - | - | - | 608-328 | 608-378 | 608-422 | 608-446 | 608-472 | 608-506 | 608-526 | 608-556* |
| 80 mm | - | - | - | - | 608-330 | 608-380 | 608-424 | 608-448 | 608-474 | 608-508 | 608-528 | 608-558 |
| 90 mm | - | - | - | - | - | - | 608-425 | 608-449 | 608-475 | 608-509 | 608-529 | 608-559 |
| 100 mm | - | - | - | - | - | - | 608-426 | 608-450 | 608-476 | 608-510 | 608-530 | 608-560 |
| 110 mm | - | - | - | - | - | - | 608-427 | 608-451 | 608-477 | 608-511 | 608-531 | 608-561 |
| 120 mm | - | - | - | - | - | - | 608-428 | 608-452 | 608-478 | 608-512 | 608-532 | 608-562 |
| 130 mm | - | - | - | - | - | - | 608-429 | - | 608-479 | 608-513 | 608-533 | 608-563 |
| 140 mm | - | - | - | - | - | - | 608-430 | - | 608-480 | 608-514 | 608-534 | 608-564 |
| 150 mm | - | - | - | - | - | - | 608-431 | - | 608-481 | 608-515 | 608-535 | 608-565 |
| 160 mm | - | - | - | - | - | - | 608-432 | - | 608-482 | - | 608-536 | 608-5667 |
| 170 mm | - | - | - | - | - | - | 608-433 | - | - | - | 608-537 | - |
| 180 mm | - | - | - | - | - | - | 608-434 | - | - | - | 608-538 | 608-5687 |
| 200 mm | - | - | - | - | - | - | 608-435 | - | - | - | 608-539 | - |

Standard Packages: M4 to M10 - 100pcs, M12 - 50 pcs, M14 to M24x80 -25pcs, M24x90 to 180mm - 10 pcs.

* - Indicates items fully threaded. Thread Length Formula is 2d+6mm.

609
Series



METRIC HEX HEAD CAP SCREWS
FINE and EXTRA FINE THREAD

610
Series

High Tensile Screws made to ISO-Metric Specifications.
Property Class: 8.8 (nominal tensile strength 800 MPa or about 118,000 p.s.i.)

Heat Treated Steel RED (Fine Thread) GREEN (Extra Fine Thread) DICHROMATE PLATED

| Dia. x Pitch | M8 x 1.0 | M10 x 1.25 | M12 x 1.5 | M14 x 1.5 | M16 x 1.5 | M18 x 1.5 | M20 x 1.5 | M10 x 1.0 | M12 x 1.25 |
|--------------|-------------|-------------|-------------|-------------|-------------|-------------|-------------|---------------|---------------|
| Length | Fine Thread | Fine Thread | Fine Thread | Fine Thread | Fine Thread | Fine Thread | Fine Thread | X-Fine Thread | X-Fine Thread |
| 20 mm | 609-316* | 609-366* | - | - | - | - | - | 610-366* | - |
| 25 mm | - | 609-368* | - | 609-436* | - | - | - | 610-368* | - |
| 30 mm | 609-320* | 609-370* | 609-414* | 609-438* | 609-464* | - | - | 610-370* | 610-414* |
| 40 mm | 609-322* | 609-372* | 609-416* | 609-440* | 609-466* | 609-500* | 609-520* | 610-372* | 610-416* |
| 45 mm | - | - | 609-417* | 609-441* | - | - | - | - | - |
| 50 mm | 609-324* | 609-374* | 609-418* | 609-442 | 609-468* | 609-502* | 609-522* | 610-374* | 610-418* |
| 55 mm | - | - | 609-419 | - | - | - | - | - | - |
| 60 mm | - | 609-376 | 609-420 | 609-444 | 609-470 | 609-504 | 609-524* | - | - |
| 65 mm | - | - | 609-421 | - | - | - | - | - | - |
| 70 mm | - | 609-378 | 609-422 | 609-446 | 609-472 | 609-506 | 609-526 | - | - |
| 80 mm | - | 609-380 | 609-424 | 609-448 | 609-474 | 609-508 | 609-528 | - | - |
| 90 mm | - | 609-382 | 609-425 | - | 609-475 | 609-509 | 609-529 | - | - |
| 100 mm | - | 609-384 | 609-426 | - | 609-476 | - | 609-530 | - | - |
| 110 mm | - | - | - | - | 609-477 | - | 609-532 | - | - |

Standard Packages: FINE THREAD - M8 to M10 x 60 -50pcs, M10x70 to M18x90 - 25 pcs, M20 - 10pcs.

EXTRA FINE THREAD - 25 pcs.

* - Indicates items fully threaded. Thread Length Formula is 2d+6mm.

612's
Series



METRIC HEX HEAD CAP SCREWS
BOULONS DE PRECISION METRIQUE



High Tensile Screws made to ISO-Metric Specifications.

Property Class: 10.9 (nominal tensile strength 1040 MPa or about 150,000 p.s.i., similar to SAE Grade 8)

Heat Treated Steel

PLAIN FINISH
REGULAR ISO COARSE THREAD SERIES

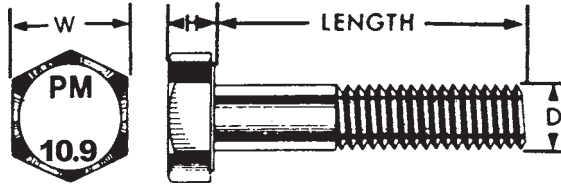

| Dia. | M6 | M8 | M10 | M12 | M14 | M16 | M20 | M24 |
|------------|----------|----------|----------|----------|----------|----------|----------|----------|
| Inch Size | .236" | .315" | .394" | .472" | .551" | .630" | .787" | .944" |
| A.F (W) | 10 | 13 | 17 | 19 | 22 | 24 | 30 | 36 |
| Height (H) | 4.0 | 5.5 | 7.0 | 8.0 | 9.0 | 10.0 | 13.0 | 15.0 |
| Pitch (mm) | 1.00 | 1.25 | 1.50 | 1.75 | 2.00 | 2.00 | 2.50 | 3.00 |
| Length | | | | | | | | |
| 20mm | 612-272* | 612-316* | 612-366* | - | - | - | - | - |
| 25mm | 612-274* | 612-318* | 612-368* | 612-412* | - | - | - | - |
| 30mm | 612-276* | 612-320* | 612-370* | 612-414* | 612-438* | - | - | - |
| 35mm | 612-277 | 612-321 | 612-371* | 612-415* | - | - | - | - |
| 40mm | 612-278 | 612-322 | 612-372 | 612-416* | 612-440* | 612-466* | - | - |
| 45mm | 612-279 | 612-323 | 612-373 | 612-417 | - | - | - | - |
| 50mm | 612-280 | 612-324 | 612-374 | 612-418 | 612-442 | 612-468 | 612-522* | 612-552* |
| 60mm | 612-282 | 612-326 | 612-376 | 612-419 | 612-444 | 612-469 | 612-524* | 612-554* |
| 70mm | - | 612-328 | 612-378 | 612-420 | 612-446 | 612-472 | 612-526 | 612-556* |
| 80mm | - | - | 612-380 | 612-422 | - | 612-474 | 612-528 | 612-558 |
| 90mm | - | - | - | 612-424 | - | 612-475 | 612-529 | 612-559 |
| 100mm | - | - | - | 612-425 | - | 612-476 | 612-530 | 612-560 |
| 110mm | - | - | - | 612-426 | - | - | 612-531 | 612-561 |
| 120mm | - | - | - | 612-428 | - | 612-478 | 612-532 | 612-562 |
| 130mm | - | - | - | - | - | - | 612-533 | 612-563 |
| 140mm | - | - | - | - | - | - | 612-534 | 612-564 |
| 150mm | - | - | - | - | - | - | 612-535 | 612-565 |
| 160mm | - | - | - | - | - | - | 612-536 | 612-566 |
| 170mm | - | - | - | - | - | - | - | 612-567 |
| 180mm | - | - | - | - | - | - | - | 612-568 |
| 200mm | - | - | - | - | - | - | - | 612-570 |

Standard Packages: M6 to M10 – 100pcs, M12 – 50 pcs, M14 to M24x80 – 25pcs, M24x90 to 180mm – 10 pcs.
* - Indicates items fully threaded. Thread Length Formula is 2d+6mm.

671
Series



METRIC HEX NUTS
ECROUS HEX METRIQUE

High Tensile Nuts conform to ISO-Metric Specifications.
Property Class: 10

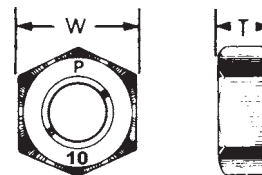

PLAIN FINISH

REGULAR ISO COARSE THREAD SERIES

| Dia. | M6 | M8 | M10 | M12 | M14 | M16 | M18 | M20 | M24 |
|------------|---------|---------|---------|---------|---------|---------|---------|---------|---------|
| A.F (W) | 10 | 13 | 17 | 19 | 22 | 24 | 27 | 30 | 36 |
| Thick. (T) | 5 | 6.5 | 8 | 9.5 | 11 | 13 | 15 | 16 | 18 |
| Pitch(mm) | 1.00 | 1.25 | 1.50 | 1.75 | 2.00 | 2.00 | 2.50 | 2.50 | 3.00 |
| Part No. | 671-006 | 671-008 | 671-010 | 671-012 | 671-014 | 671-016 | 671-018 | 671-020 | 671-024 |
| Std. Pkg. | 100 | 100 | 100 | 50 | 25 | 25 | 25 | 25 | 25 |



670
Series

papeco METRIC HEX NUTS ECROUS HEX METRIQUE

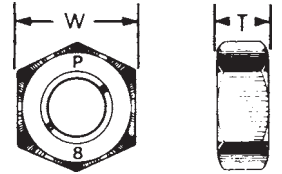

High Tensile Nuts conform to ISO-Metric Specifications.
Property Class: 8

ZINC CHROMATE PLATED

REGULAR ISO COARSE THREAD SERIES

| Dia. | M3 | M4 | M5 | M6 | M7 | M8 | M10 | M12 | M14 | M16 | M18 | M20 | M24 |
|------------|---------|---------|---------|---------|---------|---------|---------|---------|---------|---------|---------|---------|---------|
| A.F (W) | 5.5 | 7 | 8 | 10 | 10 | 13 | 17 | 19 | 22 | 24 | 27 | 30 | 36 |
| Thick. (T) | 2.4 | 3.2 | 4 | 5 | 5.5 | 6.5 | 8 | 9.5 | 11 | 13 | 15 | 16 | 18 |
| Pitch(mm) | 0.5 | 0.7 | 0.8 | 1 | 1 | 1.25 | 1.5 | 1.75 | 2 | 2 | 2.5 | 2.5 | 3 |
| Part No. | 670-003 | 670-004 | 670-005 | 670-006 | 670-007 | 670-008 | 670-010 | 670-012 | 670-014 | 670-016 | 670-018 | 670-020 | 670-024 |
| Std. Pkg. | 100 | 100 | 100 | 100 | 100 | 100 | 100 | 50 | 25 | 25 | 25 | 25 | 25 |

papeco METRIC FINE and EXTRA FINE THREAD HEX NUTS ECROUS FILETAGE METRIQUE A PAS FIN ET EXTRA FIN

High Tensile Nuts conform to ISO-Metric Specifications. Property Class: 8

FINE THREAD
RED DICHROMATE PLATED

EXTRA FINE THREAD
GREEN DICHROMATE PLATED

| Dia. | M8 | M10 | M12 | M14 | M16 | M18 | M20 | M10 | M12 |
|------------|---------|---------|---------|---------|---------|---------|---------|---------|---------|
| Pitch (mm) | 1.0 | 1.25 | 1.5 | 1.5 | 1.5 | 1.5 | 1.5 | 1.0 | 1.25 |
| Part No. | 670-208 | 670-210 | 670-212 | 670-214 | 670-216 | 670-218 | 670-220 | 670-750 | 670-765 |
| Std. Pkg. | 25 | 25 | 25 | 25 | 25 | 25 | 25 | 25 | 25 |

'POZI-LOK' NYLON COLLAR STOP NUTS

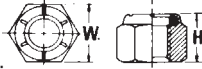

Regular ISO Coarse Thread Series

| Stock No. | Size | Width A.F. (W) | Height (H) | Std. Pkg. |
|-----------|------|-------------------|---------------|--------------|
| 700-004 | M4 | 7 | 5.0 | 100 |
| 700-005 | M5 | 8 | 5.0 | 100 |
| 700-006 | M6 | 10 | 6.0 | 100 |
| 700-008 | M8 | 13 | 8.0 | 100 |
| 700-010 | M10 | 17 | 10.0 | 100 |
| 700-012 | M12 | 19 | 12.0 | 50 |
| 700-016 | M16 | 24 | 16.0 | 25 |

'TRI-LOK' LOCK NUTS

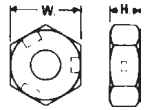

Regular ISO Coarse Thread Series

All metal for high temperature applications.

| Stock No. | Size | Width A.F. (W) | Height (H) | Std. Pkg. |
|-----------|------|-------------------|---------------|--------------|
| 705-006 | M6 | 10 | 5.0 | 100 |
| 705-008 | M8 | 13 | 6.5 | 100 |
| 705-010 | M10 | 17 | 8.0 | 100 |
| 705-012 | M12 | 19 | 10.0 | 50 |

FLAT WASHERS

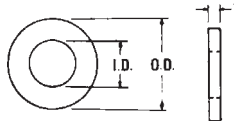

| Stock No. | Bolt Size | I.D. | O.D. | (T) Thick. | Std. Pkg. |
|-----------|--------------|------|------|---------------|--------------|
| 730-004 | 4mm | 4.3 | 9.0 | 0.8 | 100 |
| 730-005 | 5mm | 5.3 | 11.0 | 1.0 | 100 |
| 730-006 | 6mm | 6.4 | 12.5 | 1.6 | 100 |
| 730-008 | 8mm | 8.4 | 17.0 | 1.6 | 100 |
| 730-010 | 10mm | 10.5 | 21.0 | 2.0 | 100 |
| 730-012 | 12mm | 13.0 | 24.0 | 2.5 | 50 |
| 730-014 | 14mm | 15.0 | 28.0 | 2.5 | 25 |
| 730-016 | 16mm | 17.0 | 30.0 | 3.0 | 25 |
| 730-018 | 18mm | 19.0 | 34.0 | 3.0 | 25 |
| 730-020 | 20mm | 21.0 | 37.0 | 3.0 | 25 |
| 730-024 | 24mm | 25.0 | 44.0 | 4.0 | 25 |

LOCK WASHERS

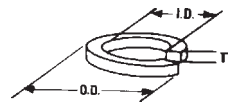

| Stock No. | Bolt Size | I.D. | O.D. | (T) Thick. | Std. Pkg. |
|-----------|--------------|------|------|---------------|--------------|
| 740-004 | 4mm | 4.1 | 7.1 | 0.9 | 100 |
| 740-005 | 5mm | 5.1 | 8.7 | 1.2 | 100 |
| 740-006 | 6mm | 6.1 | 11.1 | 1.6 | 100 |
| 740-008 | 8mm | 8.2 | 14.2 | 2.0 | 100 |
| 740-010 | 10mm | 10.2 | 17.2 | 2.2 | 100 |
| 740-012 | 12mm | 12.2 | 20.2 | 2.5 | 50 |
| 740-014 | 14mm | 14.2 | 23.2 | 3.0 | 25 |
| 740-016 | 16mm | 16.2 | 26.2 | 3.5 | 25 |
| 740-018 | 18mm | 18.2 | 28.2 | 3.5 | 25 |
| 740-020 | 20mm | 20.2 | 32.2 | 4.0 | 25 |
| 740-024 | 24mm | 24.5 | 40.0 | 5.0 | 25 |

COTTER PINS

Standard Package 100 pieces.



| Stock No. | Size | Stock No. | Size |
|-----------|--------|-----------|------|
| 752-006 | 1.5x16 | 752-027 | 3x40 |
| 752-015 | 2x20 | 752-037 | 4x50 |
| 752-024 | 3x25 | | |

MACHINE SCREWS PAN SLOT HEAD

Standard Package 100 pieces.



| Stock No. | Size | Stock No. | Size |
|-----------|-------|-----------|-------|
| 770-132 | M4x6 | 770-266 | M6x10 |
| 770-136 | M4x12 | 770-270 | M6x16 |
| 770-197 | M5x10 | 770-272 | M6x20 |
| 770-201 | M5x16 | | |

All dimensions are in millimetres.

All Standard Metric Fasteners Zinc Plated.

For Metric Wing Nuts see page 124.

Note: For other Metric Products see index.

020-425

020-426

Includes 100 pcs. M8x1.0, M10x1.0, M10x1.25, M12x1.25 and M12x1.5 Cap Screws and Nuts. Fine Thread Series.

Includes 160 pcs. M5x20, M6x20, M6x30, M8x20, M8x30, M8x40 M10x40 and M12x40 Cap Screws and Nuts. Coarse Thread Series.



METRIC MASTER ASSORTMENTS

Most popular METRIC FASTENERS packed in durable steel merchandisers with illustrated lid labels.

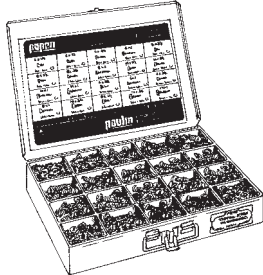

| | | | | | | | | | | | | | | | | | | | | | | | | | | | | | | | | | | | | | | | | | | | | | | | | | | | | | | | | |
|--|--------------------------------|------------------------------------|---------------------------|----------------------------|------------------------------------|-------------------|------------------|-------------|-------------------|------------------|------------|-------------------|-------------------|-------------|-------------------|-------------------|------------------------------|-------------------|--|-----------|-------------------|-------------------|------------|-------------------|-------------------|------------|----------|-------------------|----------|---------|-------------|---------|-----|---|--------------------|--------------------|-----|---|------------------------------|--------------------------------|------------------------------|----------|--------|--------|--------|--------|--------|--------|--------|--------|--------|--------|-----|--------|------|------|
| <p align="center">No. 020-730 METRIC CAP SCREWS AND NUTS Fine and Extra Fine Thread</p> <table border="0"> <tr> <td>25 pcs. Extra Fine</td> <td>40 pcs. Fine Thread</td> <td>25 pcs. Extra Fine Hex Nuts</td> </tr> <tr> <td>M10 x 1.00 x 20mm</td> <td>M8 x 1.00 x 30mm</td> <td>M10 x 1.00</td> </tr> <tr> <td>M10 x 1.00 x 25mm</td> <td>M8 x 1.00 x 50mm</td> <td>M12 x 1.25</td> </tr> <tr> <td>M10 x 1.00 x 40mm</td> <td>M10 x 1.25 x 25mm</td> <td></td> </tr> <tr> <td>M10 x 1.00 x 50mm</td> <td>M10 x 1.25 x 30mm</td> <td>40 pcs. Fine Hex Nuts</td> </tr> <tr> <td>M12 x 1.25 x 30mm</td> <td>M10 x 1.25 x 40mm</td> <td>M8 x 1.00</td> </tr> <tr> <td>M12 x 1.25 x 40mm</td> <td>M10 x 1.25 x 50mm</td> <td>M10 x 1.25</td> </tr> <tr> <td>M12 x 1.25 x 50mm</td> <td>M12 x 1.50 x 40mm</td> <td>M12 x 1.50</td> </tr> <tr> <td></td> <td>M12 x 1.50 x 50mm</td> <td></td> </tr> </table> | | | 25 pcs. Extra Fine | 40 pcs. Fine Thread | 25 pcs. Extra Fine Hex Nuts | M10 x 1.00 x 20mm | M8 x 1.00 x 30mm | M10 x 1.00 | M10 x 1.00 x 25mm | M8 x 1.00 x 50mm | M12 x 1.25 | M10 x 1.00 x 40mm | M10 x 1.25 x 25mm | | M10 x 1.00 x 50mm | M10 x 1.25 x 30mm | 40 pcs. Fine Hex Nuts | M12 x 1.25 x 30mm | M10 x 1.25 x 40mm | M8 x 1.00 | M12 x 1.25 x 40mm | M10 x 1.25 x 50mm | M10 x 1.25 | M12 x 1.25 x 50mm | M12 x 1.50 x 40mm | M12 x 1.50 | | M12 x 1.50 x 50mm | | | | | | | | | | | | | | | | | | | | | | | | | | | | |
| 25 pcs. Extra Fine | 40 pcs. Fine Thread | 25 pcs. Extra Fine Hex Nuts | | | | | | | | | | | | | | | | | | | | | | | | | | | | | | | | | | | | | | | | | | | | | | | | | | | | | | |
| M10 x 1.00 x 20mm | M8 x 1.00 x 30mm | M10 x 1.00 | | | | | | | | | | | | | | | | | | | | | | | | | | | | | | | | | | | | | | | | | | | | | | | | | | | | | | |
| M10 x 1.00 x 25mm | M8 x 1.00 x 50mm | M12 x 1.25 | | | | | | | | | | | | | | | | | | | | | | | | | | | | | | | | | | | | | | | | | | | | | | | | | | | | | | |
| M10 x 1.00 x 40mm | M10 x 1.25 x 25mm | | | | | | | | | | | | | | | | | | | | | | | | | | | | | | | | | | | | | | | | | | | | | | | | | | | | | | | |
| M10 x 1.00 x 50mm | M10 x 1.25 x 30mm | 40 pcs. Fine Hex Nuts | | | | | | | | | | | | | | | | | | | | | | | | | | | | | | | | | | | | | | | | | | | | | | | | | | | | | | |
| M12 x 1.25 x 30mm | M10 x 1.25 x 40mm | M8 x 1.00 | | | | | | | | | | | | | | | | | | | | | | | | | | | | | | | | | | | | | | | | | | | | | | | | | | | | | | |
| M12 x 1.25 x 40mm | M10 x 1.25 x 50mm | M10 x 1.25 | | | | | | | | | | | | | | | | | | | | | | | | | | | | | | | | | | | | | | | | | | | | | | | | | | | | | | |
| M12 x 1.25 x 50mm | M12 x 1.50 x 40mm | M12 x 1.50 | | | | | | | | | | | | | | | | | | | | | | | | | | | | | | | | | | | | | | | | | | | | | | | | | | | | | | |
| | M12 x 1.50 x 50mm | | | | | | | | | | | | | | | | | | | | | | | | | | | | | | | | | | | | | | | | | | | | | | | | | | | | | | | |
| <p>No. 020-725 METRIC CAP SCREWS and Nuts 255 Cap Screws - 255 Nuts - 60 Lock Nuts</p> <table border="0"> <tr><td>M4 x 16</td><td>M6 x 30</td></tr> <tr><td>M5 x 12</td><td>M6 x 35</td></tr> <tr><td>M5 x 16</td><td>M6 x 45</td></tr> <tr><td>M5 x 20</td><td>M4 Hex Nuts</td></tr> <tr><td>M5 x 25</td><td>M5</td></tr> <tr><td>M6 x 12</td><td>M6</td></tr> <tr><td>M6 x 16</td><td>M4 Locknuts</td></tr> <tr><td>M6 x 20</td><td>M5</td></tr> <tr><td>M6 x 25</td><td>M6</td></tr> </table> | M4 x 16 | M6 x 30 | M5 x 12 | M6 x 35 | M5 x 16 | M6 x 45 | M5 x 20 | M4 Hex Nuts | M5 x 25 | M5 | M6 x 12 | M6 | M6 x 16 | M4 Locknuts | M6 x 20 | M5 | M6 x 25 | M6 | <p>No. 020-726 METRIC CAP SCREWS and Nuts 83 Cap Screws - 83 Nuts - 20 Lock Nuts</p> <table border="0"> <tr><td>M8 x 12</td><td>M10 x 30</td></tr> <tr><td>M8 x 16</td><td>M10 x 40</td></tr> <tr><td>M8 x 20</td><td>M10 x 50</td></tr> <tr><td>M8 x 25</td><td>M10 x 60</td></tr> <tr><td>M8 x 30</td><td>M10 x 70</td></tr> <tr><td>M8 x 40</td><td>M8 Hex Nuts</td></tr> <tr><td>M8 x 50</td><td>M10</td></tr> <tr><td>M8 x 60</td><td>M8 Locknuts</td></tr> <tr><td>M8 x 70</td><td>M10</td></tr> </table> | M8 x 12 | M10 x 30 | M8 x 16 | M10 x 40 | M8 x 20 | M10 x 50 | M8 x 25 | M10 x 60 | M8 x 30 | M10 x 70 | M8 x 40 | M8 Hex Nuts | M8 x 50 | M10 | M8 x 60 | M8 Locknuts | M8 x 70 | M10 | <p>No. 020-727 METRIC FLAT WASHERS, SPRING WASHERS, LOCK WASHERS</p> <table border="0"> <tr> <td>425 pcs. Flat Washers</td> <td>125 pcs. Spring Washers</td> <td>450 pcs. Lock Washers</td> </tr> <tr> <td>4mm</td> <td>4mm</td> <td>4mm</td> </tr> <tr> <td>5mm</td> <td>5mm</td> <td>5mm</td> </tr> <tr> <td>6mm</td> <td>6mm</td> <td>6mm</td> </tr> <tr> <td>8mm</td> <td>8mm</td> <td>8mm</td> </tr> <tr> <td>10mm</td> <td>10mm</td> <td>10mm</td> </tr> </table> | 425 pcs. Flat Washers | 125 pcs. Spring Washers | 450 pcs. Lock Washers | 4mm | 4mm | 4mm | 5mm | 5mm | 5mm | 6mm | 6mm | 6mm | 8mm | 8mm | 8mm | 10mm | 10mm | 10mm |
| M4 x 16 | M6 x 30 | | | | | | | | | | | | | | | | | | | | | | | | | | | | | | | | | | | | | | | | | | | | | | | | | | | | | | | |
| M5 x 12 | M6 x 35 | | | | | | | | | | | | | | | | | | | | | | | | | | | | | | | | | | | | | | | | | | | | | | | | | | | | | | | |
| M5 x 16 | M6 x 45 | | | | | | | | | | | | | | | | | | | | | | | | | | | | | | | | | | | | | | | | | | | | | | | | | | | | | | | |
| M5 x 20 | M4 Hex Nuts | | | | | | | | | | | | | | | | | | | | | | | | | | | | | | | | | | | | | | | | | | | | | | | | | | | | | | | |
| M5 x 25 | M5 | | | | | | | | | | | | | | | | | | | | | | | | | | | | | | | | | | | | | | | | | | | | | | | | | | | | | | | |
| M6 x 12 | M6 | | | | | | | | | | | | | | | | | | | | | | | | | | | | | | | | | | | | | | | | | | | | | | | | | | | | | | | |
| M6 x 16 | M4 Locknuts | | | | | | | | | | | | | | | | | | | | | | | | | | | | | | | | | | | | | | | | | | | | | | | | | | | | | | | |
| M6 x 20 | M5 | | | | | | | | | | | | | | | | | | | | | | | | | | | | | | | | | | | | | | | | | | | | | | | | | | | | | | | |
| M6 x 25 | M6 | | | | | | | | | | | | | | | | | | | | | | | | | | | | | | | | | | | | | | | | | | | | | | | | | | | | | | | |
| M8 x 12 | M10 x 30 | | | | | | | | | | | | | | | | | | | | | | | | | | | | | | | | | | | | | | | | | | | | | | | | | | | | | | | |
| M8 x 16 | M10 x 40 | | | | | | | | | | | | | | | | | | | | | | | | | | | | | | | | | | | | | | | | | | | | | | | | | | | | | | | |
| M8 x 20 | M10 x 50 | | | | | | | | | | | | | | | | | | | | | | | | | | | | | | | | | | | | | | | | | | | | | | | | | | | | | | | |
| M8 x 25 | M10 x 60 | | | | | | | | | | | | | | | | | | | | | | | | | | | | | | | | | | | | | | | | | | | | | | | | | | | | | | | |
| M8 x 30 | M10 x 70 | | | | | | | | | | | | | | | | | | | | | | | | | | | | | | | | | | | | | | | | | | | | | | | | | | | | | | | |
| M8 x 40 | M8 Hex Nuts | | | | | | | | | | | | | | | | | | | | | | | | | | | | | | | | | | | | | | | | | | | | | | | | | | | | | | | |
| M8 x 50 | M10 | | | | | | | | | | | | | | | | | | | | | | | | | | | | | | | | | | | | | | | | | | | | | | | | | | | | | | | |
| M8 x 60 | M8 Locknuts | | | | | | | | | | | | | | | | | | | | | | | | | | | | | | | | | | | | | | | | | | | | | | | | | | | | | | | |
| M8 x 70 | M10 | | | | | | | | | | | | | | | | | | | | | | | | | | | | | | | | | | | | | | | | | | | | | | | | | | | | | | | |
| 425 pcs. Flat Washers | 125 pcs. Spring Washers | 450 pcs. Lock Washers | | | | | | | | | | | | | | | | | | | | | | | | | | | | | | | | | | | | | | | | | | | | | | | | | | | | | | |
| 4mm | 4mm | 4mm | | | | | | | | | | | | | | | | | | | | | | | | | | | | | | | | | | | | | | | | | | | | | | | | | | | | | | |
| 5mm | 5mm | 5mm | | | | | | | | | | | | | | | | | | | | | | | | | | | | | | | | | | | | | | | | | | | | | | | | | | | | | | |
| 6mm | 6mm | 6mm | | | | | | | | | | | | | | | | | | | | | | | | | | | | | | | | | | | | | | | | | | | | | | | | | | | | | | |
| 8mm | 8mm | 8mm | | | | | | | | | | | | | | | | | | | | | | | | | | | | | | | | | | | | | | | | | | | | | | | | | | | | | | |
| 10mm | 10mm | 10mm | | | | | | | | | | | | | | | | | | | | | | | | | | | | | | | | | | | | | | | | | | | | | | | | | | | | | | |
| <p>No. 020-728 METRIC SOCKET SET SCREWS and KEYS METRIC MACHINE SCEWS and NUTS 100 Socket Set Screws 4 Keys - 140 Machine Screws, 140 Nuts</p> <table border="0"> <tr> <td>Socket Set Screws</td> <td>Machine Screws</td> <td></td> <td></td> </tr> <tr> <td>M4 x 5</td> <td>M8 x 8</td> <td>M4 x 6</td> <td>M6 x 16</td> </tr> <tr> <td>M4 x 10</td> <td>M8 x 12</td> <td>M4 x 12</td> <td>M6 x 20</td> </tr> <tr> <td>M5 x 10</td> <td>M8 x 20</td> <td>M5 x 10</td> <td>M4 Nuts</td> </tr> <tr> <td>M5 x 15</td> <td>M2 Keys</td> <td>M5 x 16</td> <td>M5</td> </tr> <tr> <td>M6 x 8</td> <td>M2.5</td> <td>M6 x 10</td> <td>M6</td> </tr> <tr> <td>M6 x 12</td> <td>M3</td> <td></td> <td></td> </tr> <tr> <td>M6 x 20</td> <td>M4</td> <td></td> <td></td> </tr> </table> | | Socket Set Screws | Machine Screws | | | M4 x 5 | M8 x 8 | M4 x 6 | M6 x 16 | M4 x 10 | M8 x 12 | M4 x 12 | M6 x 20 | M5 x 10 | M8 x 20 | M5 x 10 | M4 Nuts | M5 x 15 | M2 Keys | M5 x 16 | M5 | M6 x 8 | M2.5 | M6 x 10 | M6 | M6 x 12 | M3 | | | M6 x 20 | M4 | | | <p>No. 020-729 METRIC COTTER PINS & SLOTTED SPRING PINS 675 Cotter Pins - 160 Spring Pins</p> <table border="0"> <tr> <td>Cotter Pins</td> <td>Spring Pins</td> <td></td> </tr> <tr> <td>1.5 x 16</td> <td>2 x 16</td> <td>4 x 50</td> </tr> <tr> <td>2 x 20</td> <td>2.5 x 18</td> <td>5 x 36</td> </tr> <tr> <td>3 x 25</td> <td>3 x 24</td> <td>5 x 50</td> </tr> <tr> <td>3 x 40</td> <td>3 x 40</td> <td>6 x 22</td> </tr> <tr> <td>4 x 50</td> <td>4 x 18</td> <td>6 x 50</td> </tr> <tr> <td></td> <td>4 x 36</td> <td></td> </tr> </table> | Cotter Pins | Spring Pins | | 1.5 x 16 | 2 x 16 | 4 x 50 | 2 x 20 | 2.5 x 18 | 5 x 36 | 3 x 25 | 3 x 24 | 5 x 50 | 3 x 40 | 3 x 40 | 6 x 22 | 4 x 50 | 4 x 18 | 6 x 50 | | 4 x 36 | | |
| Socket Set Screws | Machine Screws | | | | | | | | | | | | | | | | | | | | | | | | | | | | | | | | | | | | | | | | | | | | | | | | | | | | | | | |
| M4 x 5 | M8 x 8 | M4 x 6 | M6 x 16 | | | | | | | | | | | | | | | | | | | | | | | | | | | | | | | | | | | | | | | | | | | | | | | | | | | | | |
| M4 x 10 | M8 x 12 | M4 x 12 | M6 x 20 | | | | | | | | | | | | | | | | | | | | | | | | | | | | | | | | | | | | | | | | | | | | | | | | | | | | | |
| M5 x 10 | M8 x 20 | M5 x 10 | M4 Nuts | | | | | | | | | | | | | | | | | | | | | | | | | | | | | | | | | | | | | | | | | | | | | | | | | | | | | |
| M5 x 15 | M2 Keys | M5 x 16 | M5 | | | | | | | | | | | | | | | | | | | | | | | | | | | | | | | | | | | | | | | | | | | | | | | | | | | | | |
| M6 x 8 | M2.5 | M6 x 10 | M6 | | | | | | | | | | | | | | | | | | | | | | | | | | | | | | | | | | | | | | | | | | | | | | | | | | | | | |
| M6 x 12 | M3 | | | | | | | | | | | | | | | | | | | | | | | | | | | | | | | | | | | | | | | | | | | | | | | | | | | | | | | |
| M6 x 20 | M4 | | | | | | | | | | | | | | | | | | | | | | | | | | | | | | | | | | | | | | | | | | | | | | | | | | | | | | | |
| Cotter Pins | Spring Pins | | | | | | | | | | | | | | | | | | | | | | | | | | | | | | | | | | | | | | | | | | | | | | | | | | | | | | | |
| 1.5 x 16 | 2 x 16 | 4 x 50 | | | | | | | | | | | | | | | | | | | | | | | | | | | | | | | | | | | | | | | | | | | | | | | | | | | | | | |
| 2 x 20 | 2.5 x 18 | 5 x 36 | | | | | | | | | | | | | | | | | | | | | | | | | | | | | | | | | | | | | | | | | | | | | | | | | | | | | | |
| 3 x 25 | 3 x 24 | 5 x 50 | | | | | | | | | | | | | | | | | | | | | | | | | | | | | | | | | | | | | | | | | | | | | | | | | | | | | | |
| 3 x 40 | 3 x 40 | 6 x 22 | | | | | | | | | | | | | | | | | | | | | | | | | | | | | | | | | | | | | | | | | | | | | | | | | | | | | | |
| 4 x 50 | 4 x 18 | 6 x 50 | | | | | | | | | | | | | | | | | | | | | | | | | | | | | | | | | | | | | | | | | | | | | | | | | | | | | | |
| | 4 x 36 | | | | | | | | | | | | | | | | | | | | | | | | | | | | | | | | | | | | | | | | | | | | | | | | | | | | | | | |

METRIC GARAGE ASSORTMENTS

Most popular METRIC FASTENERS packed in divided plastic containers.

| | | | | | | | | | | | | | | | | | | | | | | | | | | | | | | |
|--|----------|-------------|---------|---------|---------|----------|--|--------|---|---|----------|---------|----------|--|----------|---------|---------|---|--------|---------|-------------|---------|---------|-----|---------|---------|----|---------|--|--|
| <p>No. 020-125 METRIC CAP SCREWS 82 pieces - 7 sizes</p> <table border="0"> <tr><td>M4 x 16</td><td>M6 x 16</td></tr> <tr><td>M5 x 16</td><td>M6 x 25</td></tr> <tr><td>M5 x 20</td><td>M6 x 35</td></tr> <tr><td>M5 x 25</td><td></td></tr> </table> | M4 x 16 | M6 x 16 | M5 x 16 | M6 x 25 | M5 x 20 | M6 x 35 | M5 x 25 | | <p>No. 020-126 METRIC CAP SCREWS 25 pieces - 7 sizes</p> <table border="0"> <tr><td>M8 x 16</td><td>M10 x 30</td></tr> <tr><td>M8 x 20</td><td>M10 x 40</td></tr> <tr><td>M8 x 25</td><td>M10 x 50</td></tr> <tr><td>M8 x 35</td><td></td></tr> </table> | M8 x 16 | M10 x 30 | M8 x 20 | M10 x 40 | M8 x 25 | M10 x 50 | M8 x 35 | | <p>No. 020-127 METRIC HEX NUTS 110 pieces - 6 sizes</p> <table border="0"> <tr><td>M4</td><td>M6</td><td>M10</td></tr> <tr><td>M5</td><td>M8</td><td>M12</td></tr> </table> | M4 | M6 | M10 | M5 | M8 | M12 | | | | | | |
| M4 x 16 | M6 x 16 | | | | | | | | | | | | | | | | | | | | | | | | | | | | | |
| M5 x 16 | M6 x 25 | | | | | | | | | | | | | | | | | | | | | | | | | | | | | |
| M5 x 20 | M6 x 35 | | | | | | | | | | | | | | | | | | | | | | | | | | | | | |
| M5 x 25 | | | | | | | | | | | | | | | | | | | | | | | | | | | | | | |
| M8 x 16 | M10 x 30 | | | | | | | | | | | | | | | | | | | | | | | | | | | | | |
| M8 x 20 | M10 x 40 | | | | | | | | | | | | | | | | | | | | | | | | | | | | | |
| M8 x 25 | M10 x 50 | | | | | | | | | | | | | | | | | | | | | | | | | | | | | |
| M8 x 35 | | | | | | | | | | | | | | | | | | | | | | | | | | | | | | |
| M4 | M6 | M10 | | | | | | | | | | | | | | | | | | | | | | | | | | | | |
| M5 | M8 | M12 | | | | | | | | | | | | | | | | | | | | | | | | | | | | |
| <p>No. 020-128 METRIC NYLON COLLAR LOCK NUTS 33 pieces - 5 sizes</p> <table border="0"> <tr><td>M4</td><td>M8</td></tr> <tr><td>M5</td><td>M10</td></tr> <tr><td>M6</td><td></td></tr> </table> | M4 | M8 | M5 | M10 | M6 | | <p>No. 020-129 METRIC FLAT WASHERS 235 pieces - 5 sizes</p> <table border="0"> <tr><td>4mm</td><td>8mm</td></tr> <tr><td>5mm</td><td>10mm</td></tr> <tr><td>6mm</td><td></td></tr> </table> | 4mm | 8mm | 5mm | 10mm | 6mm | | <p>No. 020-130 METRIC LOCK WASHERS 300 pieces - 5 sizes</p> <table border="0"> <tr><td>4mm</td><td>6mm</td><td>10mm</td></tr> <tr><td>5mm</td><td>8mm</td><td></td></tr> </table> | 4mm | 6mm | 10mm | 5mm | 8mm | | | | | | | | | | | |
| M4 | M8 | | | | | | | | | | | | | | | | | | | | | | | | | | | | | |
| M5 | M10 | | | | | | | | | | | | | | | | | | | | | | | | | | | | | |
| M6 | | | | | | | | | | | | | | | | | | | | | | | | | | | | | | |
| 4mm | 8mm | | | | | | | | | | | | | | | | | | | | | | | | | | | | | |
| 5mm | 10mm | | | | | | | | | | | | | | | | | | | | | | | | | | | | | |
| 6mm | | | | | | | | | | | | | | | | | | | | | | | | | | | | | | |
| 4mm | 6mm | 10mm | | | | | | | | | | | | | | | | | | | | | | | | | | | | |
| 5mm | 8mm | | | | | | | | | | | | | | | | | | | | | | | | | | | | | |
| <p>No. 020-131 METRIC SPRING WASHERS 250 pieces - 5 sizes</p> <table border="0"> <tr><td>4mm</td><td>8mm</td></tr> <tr><td>5mm</td><td>10mm</td></tr> <tr><td>6mm</td><td></td></tr> </table> | 4mm | 8mm | 5mm | 10mm | 6mm | | <p>No. 020-132 METRIC SOCKET SET SCREWS 29 pieces - 10 sizes</p> <table border="0"> <tr><td>M4 x 5</td><td>M6 x 12</td></tr> <tr><td>M4 x 10</td><td>M6 x 20</td></tr> <tr><td>M5 x 10</td><td>M8 x 8</td></tr> <tr><td>M5 x 15</td><td>M8 x 12</td></tr> <tr><td>M6 x 8</td><td>M8 x 20</td></tr> </table> | M4 x 5 | M6 x 12 | M4 x 10 | M6 x 20 | M5 x 10 | M8 x 8 | M5 x 15 | M8 x 12 | M6 x 8 | M8 x 20 | <p>No. 020-133 METRIC MACHINE SCREWS and NUTS 105 Screws, 7 sizes - 105 nuts, 3 sizes</p> <table border="0"> <tr><td>M4 x 6</td><td>M6 x 10</td><td>M4 Hex Nuts</td></tr> <tr><td>M4 x 12</td><td>M6 x 16</td><td>M5</td></tr> <tr><td>M5 x 10</td><td>M6 x 20</td><td>M6</td></tr> <tr><td>M5 x 16</td><td></td><td></td></tr> </table> | M4 x 6 | M6 x 10 | M4 Hex Nuts | M4 x 12 | M6 x 16 | M5 | M5 x 10 | M6 x 20 | M6 | M5 x 16 | | |
| 4mm | 8mm | | | | | | | | | | | | | | | | | | | | | | | | | | | | | |
| 5mm | 10mm | | | | | | | | | | | | | | | | | | | | | | | | | | | | | |
| 6mm | | | | | | | | | | | | | | | | | | | | | | | | | | | | | | |
| M4 x 5 | M6 x 12 | | | | | | | | | | | | | | | | | | | | | | | | | | | | | |
| M4 x 10 | M6 x 20 | | | | | | | | | | | | | | | | | | | | | | | | | | | | | |
| M5 x 10 | M8 x 8 | | | | | | | | | | | | | | | | | | | | | | | | | | | | | |
| M5 x 15 | M8 x 12 | | | | | | | | | | | | | | | | | | | | | | | | | | | | | |
| M6 x 8 | M8 x 20 | | | | | | | | | | | | | | | | | | | | | | | | | | | | | |
| M4 x 6 | M6 x 10 | M4 Hex Nuts | | | | | | | | | | | | | | | | | | | | | | | | | | | | |
| M4 x 12 | M6 x 16 | M5 | | | | | | | | | | | | | | | | | | | | | | | | | | | | |
| M5 x 10 | M6 x 20 | M6 | | | | | | | | | | | | | | | | | | | | | | | | | | | | |
| M5 x 16 | | | | | | | | | | | | | | | | | | | | | | | | | | | | | | |
| <p>No. 020-135 METRIC SLOTTED SPRING PINS 64 pieces - 8 sizes</p> <table border="0"> <tr><td>2 x 16</td><td>3 x 40</td><td>4 x 36</td><td>5 x 50</td></tr> <tr><td>2.5 x 18</td><td>4 x 18</td><td>5 x 36</td><td>6 x 50</td></tr> </table> | | 2 x 16 | 3 x 40 | 4 x 36 | 5 x 50 | 2.5 x 18 | 4 x 18 | 5 x 36 | 6 x 50 | <p>No. 020-134 METRIC COTTER PINS 275 pieces - 5 sizes</p> <table border="0"> <tr><td>1.5 x 16</td><td>3 x 25</td><td>4 x 50</td></tr> <tr><td>2 x 20</td><td>3 x 40</td><td></td></tr> </table> | 1.5 x 16 | 3 x 25 | 4 x 50 | 2 x 20 | 3 x 40 | | | | | | | | | | | | | | | |
| 2 x 16 | 3 x 40 | 4 x 36 | 5 x 50 | | | | | | | | | | | | | | | | | | | | | | | | | | | |
| 2.5 x 18 | 4 x 18 | 5 x 36 | 6 x 50 | | | | | | | | | | | | | | | | | | | | | | | | | | | |
| 1.5 x 16 | 3 x 25 | 4 x 50 | | | | | | | | | | | | | | | | | | | | | | | | | | | | |
| 2 x 20 | 3 x 40 | | | | | | | | | | | | | | | | | | | | | | | | | | | | | |
| <p align="center">For SUPER-SERVICE ASSORTMENT No. 020-842 of Metric Fasteners refer to page 9.</p> | | | | | | | | | | | | | | | | | | | | | | | | | | | | | | |



GRADE 5 HEX HEAD CAP SCREWS BOULONS DE PRECISION CLASSE 5

• MADE TO S.A.E.
J429 SPECIFICATIONS

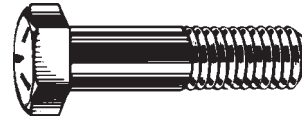

- MEDIUM CARBON STEEL
- DOUBLE HEAT TREATED
- BARE METAL

073
UNC
Coarse

"Papco" Grade 5 Cap Screws, identified by the three radial bar head marking, are made of medium carbon steel, quenched and tempered for higher tensile strength and holding power. Tensile Strength: up to 1" dia. -120,000 p.s.i.(min.) 1-1/8" dia. up -105,000 p.s.i.(min.)

074
UNF
Fine

ORDER BY STOCK NUMBER

UNC Coarse Thread, add prefix 073

UNF Fine Thread, add prefix 074

Example of Stock No. 073-586 is 1/2 x 2 Coarse Thread Grade 5 Cap Screw Bare Metal.

| Threads UNC | 20 | 18 | 16 | 14 | 13 | 12 | 11 | 10 | 9 | 8 | 7 | 7 | 6 |
|-------------------------|------|-------|---------|------|--------|-------|-------|-------|--------|--------|-------------|--------|--------|
| UNF | 28 | 24 | 24 | 20 | 20 | 18 | 18 | 16 | 14 | 14 | 12 | 12 | 12 |
| Diameter | 1/4 | 5/16 | 3/8 | 7/16 | 1/2 | 9/16 | 5/8 | 3/4 | 7/8 | 1" | 1-1/8" | 1-1/4" | 1-1/2" |
| 1/2 | -305 | -440 | -485 | | | | | | | | | | |
| 3/4 | -307 | -442 | -487 | -532 | | | | | | | | | |
| 1 | -309 | -444 | -489 | -534 | -579 | -623 | -668 | | | | | | |
| 1-1/4 | -311 | -446 | -491 | -536 | -581 | -625 | -670 | | | | | | |
| 1-1/2 | -313 | -448 | -493 | -538 | -583 | -627 | -672 | -714 | | | | | |
| 1-3/4 | -315 | -450 | -495 | -540 | -585 | -629 | -674 | -716 | -761 | -802 | | | |
| 2 | -316 | -451 | -496 | -541 | -586 | -630 | -675 | -717 | -762 | -803 | | | |
| 2-1/4 | -317 | -452 | -497 | -542 | -587 | -631 | -676 | -718 | -763 | -804 | | | |
| 2-1/2 | -318 | -453 | -498 | -543 | -588 | -632 | -677 | -719 | -764 | -805 | -845 | -885 | |
| 2-3/4 | -319 | -454 | -499 | -544 | -589 | -633 | -678 | -720 | | | | | |
| 3 | -320 | -455 | -500 | -545 | -590 | -634 | -679 | -721 | -766 | -807 | -847 | -887 | |
| 3-1/2 | -322 | -457 | -502 | -547 | -592 | -636 | -681 | -723 | -768 | -809* | -849 | -889 | |
| 4 | -324 | -459 | -504 | -549 | -594 | -638 | -683 | -725 | -770 | -811* | -851 | -891 | -961 |
| 4-1/2 | -325 | -460 | -505 | -550 | -595 | -639 | -684 | -726 | -771 | -812* | -852 | -892 | -962 |
| 5 | -326 | -461 | -506* | -551 | -596 | -640 | -685 | -727 | -772 | -813* | -853 | -893 | -963 |
| 5-1/2 | -327 | -462 | -507* | -552 | -597 | -641 | -686 | -728 | -773* | -814* | -854 | -894 | -964 |
| 6 | -329 | -464 | -509* | -554 | -599* | -643 | -688 | -730 | -775* | -816* | -856 | -896 | -966 |
| 7 | | | | | -601* | | -690 | -732 | -777* | -818* | -858 | -898 | -968 |
| 8 | | | | | -603* | | -692 | -734 | -779* | -820* | -860 | -900 | -970 |
| Head Width Across Flats | 7/16 | 1/2 | 9/16 | 5/8 | 3/4 | 13/16 | 15/16 | 1-1/8 | 1-5/16 | 1-1/2 | 1-11/16 | 1-7/8 | 2-1/4 |
| Head Height | 5/32 | 13/64 | 15/64 | 9/32 | 5/16 | 23/64 | 25/64 | 15/32 | 35/64 | 39/64 | 11/16 | 25/32 | 15/16 |
| Std. Packages | 100 | 100 | 100 *50 | 50 | 50 *25 | 25 | 25 | 20 | 20 *10 | 20 *10 | As Required | | |

085
UNC
Coarse

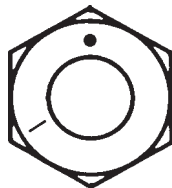

GRADE 5 HEX NUTS ECROUS HEX CLASSE 5



086
UNF
Fine

• MADE TO STANDARD FINISHED
HEXAGON NUT DIMENSIONS

• BARE METAL

| Diameter | 1/4 | 5/16 | 3/8 | 7/16 | 1/2 | 9/16 | 5/8 | 3/4 | 7/8 | 1" |
|----------------------|---------|---------|---------|---------|---------|---------|---------|---------|---------|---------|
| Stock No. UNC Coarse | 085-014 | 085-016 | 085-018 | 085-020 | 085-022 | 085-023 | 085-024 | 085-026 | 085-028 | 085-030 |
| UNF Fine | 086-014 | 086-016 | 086-018 | 086-020 | 086-022 | 086-023 | 086-024 | 086-026 | 086-028 | 086-030 |
| Std. Pkgs. | 100 | 100 | 100 | 50 | 50 | 25 | 25 | 20 | 20 | 20 |

For Grade 2 Plated and Bare Hex Nuts see page 31.



GRADE 2 HEX HEAD CAP SCREWS BOULONS DE PRECISION CLASSE 2

069
UNC
Bare

"Papco" Grade 2 Cap Screws are made from low carbon steel and have no head bar markings. Tensile Strength: up to 5/8" dia. -64,000 p.s.i.(min.) 3/4" dia. up -55,000 p.s.i.(min.)

ORDER BY STOCK NUMBER

UNC Coarse Thread Zinc Plated, add prefix 071

Example of Stock No. 071-586 is 1/2 x 2 Coarse Thread Grade 2 Cap Screw Zinc Plated.

071
UNC
Plated

Note: Bolt strength is indicated by head marking. Do not replace with a lower grade than the original.



papco® PLATED GRADE 5 HEX HEAD CAP SCREWS BOULONS DE PRECISION CLASSE 5 PLAQUE

- MEDIUM CARBON STEEL
- MADE TO S.A.E. J429 SPECIFICATIONS



- DOUBLE HEAT TREATED
- BRIGHT ELECTRO-PLATED WITH CHROMATE FINISH

"Papco" Plated Grade 5 Cap Screws are identified by the three radial bar head marking and are made of medium carbon steel, quenched and tempered for higher tensile strength and holding power. Bright electro-plated with chromate finish to resist rust. Tensile Strength: up to 1" dia. -120,000 p.s.i.(min.) 1-1/8" dia. up -105,000 p.s.i.(min.)

075
UNC
Coarse

076
UNF
Fine

ORDER BY STOCK NUMBER

UNC Coarse Thread Plated, add prefix 075 UNF Fine Thread Plated, add prefix 076
Example of Stock No. 075-586 is 1/2 x 2 Coarse Thread Plated Grade 5 Cap Screw.

| Threads UNC | 20 | 18 | 16 | 14 | 13 | 12 | 11 | 10 | 9 | 8 | 7 | 7 | 6 |
|-------------------------|------|-------|---------|------|--------|-------|-------|-------|--------|--------|-------------|--------|--------|
| UNF | 28 | 24 | 24 | 20 | 20 | 18 | 18 | 16 | 14 | 14 | 12 | 12 | 12 |
| Diameter | 1/4 | 5/16 | 3/8 | 7/16 | 1/2 | 9/16 | 5/8 | 3/4 | 7/8 | 1" | 1-1/8" | 1-1/4" | 1-1/2" |
| 1/2 | -305 | -440 | | | | | | | | | | | |
| 3/4 | -307 | -442 | -487 | -532 | | | | | | | | | |
| 1 | -309 | -444 | -489 | -534 | -579 | -623 | -668 | | | | | | |
| 1-1/4 | -311 | -446 | -491 | -536 | -581 | -625 | -670 | | | | | | |
| 1-1/2 | -313 | -448 | -493 | -538 | -583 | -627 | -672 | -714 | | | | | |
| 1-3/4 | -315 | -450 | -495 | -540 | -585 | | -674 | -716 | | | | | |
| 2 | -316 | -451 | -496 | -541 | -586 | -630 | -675 | -717 | -762 | | | | |
| 2-1/4 | -317 | -452 | -497 | | -587 | | -676 | -718 | -763 | | | | |
| 2-1/2 | -318 | -453 | -498 | -543 | -588 | -632 | -677 | -719 | -764 | -805 | | | |
| 2-3/4 | | | | | | | | | | | | | |
| 3 | -320 | -455 | -500 | -545 | -590 | -634 | -679 | -721 | -766 | -807 | | -887 | |
| 3-1/2 | -322 | -457 | -502 | -547 | -592 | | -681 | -723 | -768 | -809* | | | |
| 4 | -324 | -459 | -504 | -549 | -594 | | -683 | -725 | -770 | -811* | | -891 | |
| 4-1/2 | -325 | -460 | -505 | | -595 | | -684 | -726 | -771 | -812* | | | |
| 5 | -326 | -461 | -506* | | -596 | | -685 | -727 | -772 | -813* | | -893 | |
| 5-1/2 | | | | | -597 | | -686 | -728 | -773* | -814* | | | |
| 6 | | | -509* | -554 | -599* | | -688 | -730 | -775* | -816* | | -896 | |
| 7 | | | | | | | | | | | | | |
| 8 | | | | | | | | | | | | | |
| Head Width Across Flats | 7/16 | 1/2 | 9/16 | 5/8 | 3/4 | 13/16 | 15/16 | 1-1/8 | 1-5/16 | 1-1/2 | 1-11/16 | 1-7/8 | 2-1/4 |
| Head Height | 5/32 | 13/64 | 15/64 | 9/32 | 5/16 | 23/64 | 25/64 | 15/32 | 35/64 | 39/64 | 11/16 | 25/32 | 15/16 |
| Std. Packages | 100 | 100 | 100 *50 | 50 | 50 *25 | 25 | 25 | 20 | 20 *10 | 20 *10 | As Required | | |

087
UNC
Coarse

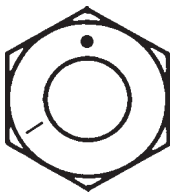

papco® PLATED GRADE 5 HEX NUTS ECROUS HEX CLASSE 5 PLAQUE

- BRIGHT ELECTRO-PLATED WITH CHROMATE FINISH



- MADE TO STANDARD FINISHED HEXAGON NUT DIMENSIONS



088
UNF
Fine

| Diameter | 1/4 | 5/16 | 3/8 | 7/16 | 1/2 | 9/16 | 5/8 | 3/4 | 7/8 | 1" |
|----------------------|---------|---------|---------|---------|---------|---------|---------|---------|---------|---------|
| Stock No. UNC Coarse | 087-014 | 087-016 | 087-018 | 087-020 | 087-022 | 087-023 | 087-024 | 087-026 | 087-028 | 087-030 |
| UNF Fine | 088-014 | 088-016 | 088-018 | 088-020 | 088-022 | 088-023 | 088-024 | 088-026 | 088-028 | 088-030 |
| Std. Pkgs. | 100 | 100 | 100 | 50 | 50 | 25 | 25 | 20 | 20 | 20 |

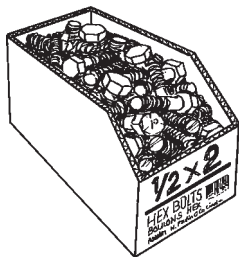

papco® PLATED BULK FASTENERS

1/8 keg - 25 lbs. (maximum)

BRIGHT ELECTRO-PLATED WITH CHROMATE FINISH



"Papco" Plated Grade 5 Cap Screws, Hex Nuts, Washers, Carriage Bolts, Lag Bolts and screw products series No. 845. See price book for bulk quantities and sizes.



papeco[®] CAP SCREW and NUT ASSORTMENTS ASSORTIMENTS DE BOULONS DE PRECISION et ECROUS

CAP SCREW AND NUT UTILITY ASSORTMENTS



Each size in these popular assortments is in a separate compartment in a sturdy fibre-board container. Plated Grade 5 Cap Screws and Nuts. Dimensions and retail codes shown in lid.

No. 020-326 contains 105 Fine Thread Screws in sizes from 1/4 x 3/4 to 1/2 x 1-1/2.

No. 020-327 contains 105 Coarse Thread Screws in sizes from 1/4 x 3/4 to 1/2 x 1-1/2.

No. 020-347 contains 133 Hexagon Nuts in Fine, and Coarse sizes from 1/4" to 1/2" Diameter.

CAP SCREW AND NUT MASTER ASSORTMENTS



Packed in metal, sectional divided box with moulded plastic compartments. The hinged, safety-lock lid may be closed and carried to the job. Contains the most popular sizes of Plated Grade 5 Cap Screws.

MASTER ASSORTMENT No. 020-622

Contains 20 best sizes of Plated Grade 5 Screws, Nuts, Washers, Stove Bolts and Cotter Pins.

U N C CAP SCREWS — 1/4 x 3/4; 1/4 x 1; 5/16 x 3/4; 5/16 x 1; 3/8 x 1; 3/8 x 1-1/2.

U N C NUTS — 1/4 ; 5/16 ; 3/8. LOCKWASHERS — 1/4 ; 5/16 ; 3/8.

S.A.E WASHERS — 1/4 ; 5/16 ; 3/8. STOVEBOLTS — 3/16 x 1 ; 1/4 x 3/4 ; 1/4 x 1.

COTTER PINS — 3/32 x 1 ; 1/8 x 2.

Have all the MOST USED sizes of Fasteners available when you need them.

No. 020-646 Contains 208 Plated Grade 5, UNF Fine Thread Cap Screws — 20 sizes.

No. 020-647 Contains 208 Plated Grade 5, UNC Coarse Thread Cap Screws — 20 sizes.

No. 020-648 Contains 376 Plated Hex Nuts, Coarse, Fine, and Castellated — 18 sizes.

COMPARATIVE STRENGTH OF CAP SCREWS

| MINIMUM TENSILE STRENGTH p. s. i. (pounds per sq. inch) | S.A.E. Grades 2, 5, 8 and 'Papcolloy' | | I.S.O. Metric Property Classes | | MINIMUM TENSILE STRENGTH MPa (megapascals) |
|---|--|--------|----------------------------------|--------|--|
| | GRADE | Symbol | CLASS | Symbol | |
| 180,000 | 'PAPCOLLOY' | | CLASS 12.9 | | 1220 |
| 170,000 | GRADE 8 | | CLASS 10.9 | | 1040 |
| 150,000 | GRADE 5 | | CLASS 9.8 | | 900 |
| 140,000 | | | CLASS 8.8 | | 830 |
| 130,000 | | | CLASS 5.8 | | 520 |
| 120,000 | GRADE 2 | | | | |
| 110,000 | | | | | |
| 100,000 | | | | | |
| 90,000 | | | | | |
| 80,000 | | | | | |
| 70,000 | | | | | |
| 60,000 | | | | | |
| 50,000 | | | | | |
| | 1/4, 5/16, 3/8, 7/16, 1/2, 9/16, 5/8, 3/4, 7/8, 1", 1-1/8, 1-1/4, 1-3/8, 1-1/2 | | M5 — — — M16 — — — M24 — — — M36 | | |
| | Diameter (inches) | | Diameter (millimetres) | | |



GRADE 8 HEX HEAD CAP SCREWS BOULONS DE PRECISION CLASSE 8



077
Coarse
Bare

- MEDIUM CARBON ALLOY STEEL
- SIX RADIAL BARS
- DOUBLE HEAT TREATED



- MADE TO S.A.E. J429 SPECIFICATIONS
- GOLD ZINC DICHROMATE PLATED OR BARE METAL

078
Fine
Bare

079
Coarse
Plated

"Papco" Grade 8 Cap Screws, identified by the six radial bar head marking, are made of medium carbon alloy steel, quenched and tempered for stronger, safer, more reliable mechanical joints. Use with Grade 8 Nuts to develop the full strength of the Cap Screw. Tensile Strength: 150,000 p.s.i. (min.).

080
Fine
Plated

ORDER BY STOCK NUMBER

Plated UNC Coarse Thread, add prefix 079 Plated UNF Fine Thread, add prefix 080
Example of Stock No. 079-586 is 1/2 x 2 Coarse Thread Plated Grade 8 Cap Screw.

| Threads UNC | 20 | 18 | 16 | 14 | 13 | 12 | 11 | 10 | 9 | 8 | 7 | 7 | 6 |
|-------------------------|------|-------|---------|------|--------|-------|-------|-------|--------|--------|-------------|--------|--------|
| UNF | 28 | 24 | 24 | 20 | 20 | 18 | 18 | 16 | 14 | 14 | 12 | 12 | 12 |
| Diameter | 1/4 | 5/16 | 3/8 | 7/16 | 1/2 | 9/16 | 5/8 | 3/4 | 7/8 | 1" | 1-1/8" | 1-1/4" | 1-1/2" |
| 1/2 | -305 | -440 | | | | | | | | | | | |
| 3/4 | -307 | -442 | -487 | | | | | | | | | | |
| 1 | -309 | -444 | -489 | -534 | -579 | | -668 | | | | | | |
| 1-1/4 | -311 | -446 | -491 | -536 | -581 | | | | | | | | |
| 1-1/2 | -313 | -448 | -493 | -538 | -583 | | -672 | -714 | | | | | |
| 1-3/4 | -315 | -450 | -495 | -541 | -585 | | -674 | | | | | | |
| 2 | -316 | -451 | -496 | -541 | -586 | | -675 | -717 | -762 | -803 | | | |
| 2-1/4 | -317 | -452 | -497 | -541 | -587 | | -676 | | | | | | |
| 2-1/2 | -318 | -453 | -498 | -543 | -588 | | -677 | -719 | -764 | -805 | | | |
| 2-3/4 | | | | | | | | | | | | | |
| 3 | -320 | -455 | -500 | -545 | -590 | | -679 | -721 | -766 | -807 | | -887 | |
| 3-1/2 | -322 | -457 | -502 | -547 | -592 | | -681 | -723 | -768 | -809* | | | |
| 4 | -324 | -459 | -504 | -549 | -594 | | -683 | -725 | -770 | -811* | | -891 | |
| 4-1/2 | | | | -550 | -595 | | -684 | -726 | | | | | |
| 5 | -326 | -461 | -506* | -551 | -596 | | -685 | -727 | -772 | -813* | | -893 | |
| 5-1/2 | | | | | | | | | | | | | |
| 6 | -329 | -464 | -509* | -554 | -599* | | -688 | -730 | -775* | -816* | | -896 | |
| 7 | | | | | | | -690 | -732 | -777* | -818* | | | |
| 8 | | | | | | | -692 | -734 | -779* | -820* | | -900 | |
| Head Width Across Flats | 7/16 | 1/2 | 9/16 | 5/8 | 3/4 | 13/16 | 15/16 | 1-1/8 | 1-5/16 | 1-1/2 | 1-11/16 | 1-7/8 | 2-1/4 |
| Head Height | 5/32 | 13/64 | 15/64 | 9/32 | 5/16 | 23/64 | 25/64 | 15/32 | 35/64 | 39/64 | 11/16 | 25/32 | 15/16 |
| Std. Packages | 100 | 100 | 100 *50 | 50 | 50 *25 | | 25 | 20 | 20 *10 | 20 *10 | As Required | | |

089
Coarse
Bare



GRADE 8 HEX NUTS ECROUS HEX CLASSE 8

090
Fine
Bare

091
Coarse
Plated

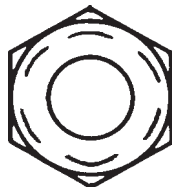

FINISHED

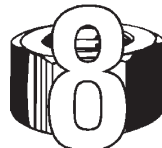

- GOLD ZINC DICHROMATE PLATED OR BARE
- MADE TO STANDARD FINISHED HEXAGON NUT DIMENSIONS

092
Fine
Plated

| Diameter | 1/4 | 5/16 | 3/8 | 7/16 | 1/2 | 9/16 | 5/8 | 3/4 | 7/8 | 1" |
|--------------|------|------|------|-------|------|------|-------|-------|--------|-------|
| Stock No. | -014 | -016 | -018 | -020 | -022 | | -024 | -026 | -028 | -030 |
| Across Flats | 7/16 | 1/2 | 9/16 | 11/16 | 3/4 | | 15/16 | 1-1/8 | 1-5/16 | 1-1/2 |
| Std. Pkgs. | 100 | 100 | 100 | 50 | 50 | | 25 | 20 | 20 | 20 |

For Grade 8 Flat Washers see 101 Series Tension Washers - Lock Washers see 101 Series 'Papcolloy' Lock Washers, pages 32 and 33.



papeco[®] HEX NUTS ECROUS HEX

FINISHED

081
UNC
Coarse

**GRADE 2
HEX NUTS***
(Finished)

082
UNF
Fine

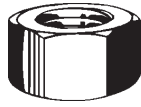

BARE
METAL

**PLATED
GRADE 2
HEX NUTS**
(Finished)

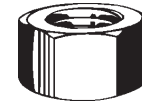

083
UNC
Coarse

084
UNF
Fine

(COARSE THREAD - UNC)
(FINE THREAD - UNF)

(COARSE THREAD - UNC)
(FINE THREAD - UNF)

| Stock Number | | Size | Std. Pkg. | Width Across Flats | Thickness |
|--------------|----------|-------|-----------|--------------------|-----------|
| UNC Coarse | UNF Fine | | | | |
| 081-014 | 082-014 | 1/4 | 100 | 7/16 | 7/32 |
| 081-016 | 082-016 | 5/16 | 100 | 1/2 | 17/64 |
| 081-018 | 082-018 | 3/8 | 100 | 9/16 | 21/64 |
| 081-020 | 082-020 | 7/16 | 50 | 11/16 | 3/8 |
| 081-022 | 082-022 | 1/2 | 50 | 3/4 | 7/16 |
| 081-023 | 082-023 | 9/16 | 25 | 7/8 | 31/64 |
| 081-024 | 082-024 | 5/8 | 25 | 15/16 | 35/64 |
| 081-026 | 082-026 | 3/4 | 20 | 1-1/8 | 41/64 |
| 081-028 | 082-028 | 7/8 | 20 | 1-5/16 | 3/4 |
| 081-030 | 082-030 | 1 | 20 | 1-1/2 | 55/64 |
| 081-032 | 082-032 | 1-1/8 | 15 | 1-11/16 | 31/32 |
| 081-034 | 082-034 | 1-1/4 | 15 | 1-7/8 | 1-1/16 |
| 081-037 | 082-037 | 1-3/8 | 10 | 2-1/16 | 1-11/64 |
| 081-038 | 082-038 | 1-1/2 | 10 | 2-1/4 | 1-9/32 |

| Stock Number | | Size | Std. Pkg. | Width Across Flats | Thickness |
|--------------|----------|------|-----------|--------------------|-----------|
| UNC Coarse | UNF Fine | | | | |
| 083-014 | 084-014 | 1/4 | 100 | 7/16 | 7/32 |
| 083-016 | 084-016 | 5/16 | 100 | 1/2 | 17/64 |
| 083-018 | 084-018 | 3/8 | 100 | 9/16 | 21/64 |
| 083-020 | 084-020 | 7/16 | 50 | 11/16 | 3/8 |
| 083-022 | 084-022 | 1/2 | 50 | 3/4 | 7/16 |
| 083-023 | 084-023 | 9/16 | 25 | 7/8 | 31/64 |
| 083-024 | 084-024 | 5/8 | 25 | 15/16 | 35/64 |
| 083-026 | 084-026 | 3/4 | 20 | 1-1/8 | 41/64 |
| 083-028 | 084-028 | 7/8 | 20 | 1-5/16 | 3/4 |
| 083-030 | 084-030 | 1 | 20 | 1-1/2 | 55/64 |
| | | | | | |
| | | | | | |

UNC HEAVY HEX NUTS*

094
Series

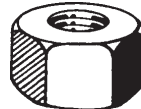

(COARSE THREAD - UNC)

UNF THICK SLOTTED HEX NUTS (Finished)



093
Series

(FINE THREAD - UNF)

| Stock Number | Nut Size and Thread | Std. Pkg. | Width Across Flats | Thickness |
|--------------|---------------------|-----------|--------------------|-----------|
| 094-014 | 1/4-20 | 100 | 1/2 | 15/64 |
| 094-016 | 5/16-18 | 100 | 9/16 | 19/64 |
| 094-018 | 3/8-16 | 100 | 11/16 | 23/64 |
| 094-020 | 7/16-14 | 50 | 3/4 | 27/64 |
| 094-022 | 1/2-13 | 50 | 7/8 | 31/64 |
| 094-023 | 9/16-12 | 25 | 15/16 | 35/64 |
| 094-024 | 5/8-11 | 25 | 1-1/16 | 39/64 |
| 094-026 | 3/4-10 | 20 | 1-1/4 | 47/64 |
| 094-028 | 7/8-9 | 20 | 1-7/16 | 55/64 |
| 094-030 | 1-8 | 20 | 1-5/8 | 63/64 |
| 094-032 | 1-1/8-7 | 15 | 1-13/16 | 1-7/64 |
| 094-034 | 1-1/4-7 | 15 | 2 | 1-7/32 |
| 094-037 | 1-3/8-6 | 10 | 2-3/16 | 1-11/32 |
| 094-038 | 1-1/2-6 | 10 | 2-3/8 | 1-15/32 |

| Stock Number | Nut Size and Thread | Std. Pkg. | Width Across Flats | Thickness |
|--------------|---------------------|-----------|--------------------|-----------|
| 093-014 | 1/4-28 | 100 | 7/16 | 9/32 |
| 093-016 | 5/16-24 | 100 | 1/2 | 21/64 |
| 093-018 | 3/8-24 | 100 | 9/16 | 13/32 |
| 093-020 | 7/16-20 | 50 | 11/16 | 29/64 |
| 093-022 | 1/2-20 | 50 | 3/4 | 9/16 |
| 093-023 | 9/16-18 | 25 | 7/8 | 39/64 |
| 093-024 | 5/8-18 | 25 | 15/16 | 23/32 |
| 093-026 | 3/4-16 | 20 | 1-1/8 | 13/16 |
| 093-028 | 7/8-14 | 20 | 1-5/16 | 29/32 |
| 093-030 | 1-14 | 20 | 1-1/2 | 1 |
| 093-032 | 1-1/8-12 | 15 | 1-11/16 | 1-5/32 |
| 093-034 | 1-1/4-12 | 15 | 1-7/8 | 1-1/4 |
| 093-037 | 1-3/8-12 | 10 | 2-1/16 | 1-3/8 |
| 093-038 | 1-1/2-12 | 10 | 2-1/4 | 1-1/2 |

* Jam Nuts also available in sizes listed.

Note: These Nuts conform to ANSI Standard B18.2.2. Nuts with Left Hand Threads are available.

papcolloy SUPER HIGH STRENGTH FASTENERS



095
UNC
Coarse

- EXCEED S.A.E. GRADE 8 SPECIFICATIONS
- MADE OF ALLOY STEEL
- GOLD ZINC DICHROMATE PLATED



- SPECIAL HIGH HEADS FOR EXTRA WRENCH AREA
- OVER 50% STRONGER THAN GRADE 5 SCREWS
- TWICE THE IMPACT STRENGTH OF GRADE 2 SCREWS

096
UNF
Fine

"Papcolloy" Hexagon Head Cap Screws are the strongest, toughest, hardest, most durable standard fasteners available.

ORDER BY STOCK NUMBER

UNC Coarse Thread, add prefix 095

UNF Fine Thread, add prefix 096

Example of Stock No. 095-586 is 1/2 x 2 Coarse Thread 'Papcolloy' Cap Screw.

| Threads UNC | 20 | 18 | 16 | 14 | 13 | 12 | 11 | 10 | 9 | 8 | 7 | 7 | 6 |
|-------------------------|------|-------|------|-------|-------|-------|-------|-------|--------|-------|-------------|--------|--------|
| UNF | 28 | 24 | 24 | 20 | 20 | 18 | 18 | 16 | 14 | 14 | 12 | 12 | 12 |
| Diameter | 1/4 | 5/16 | 3/8 | 7/16 | 1/2 | 9/16 | 5/8 | 3/4 | 7/8 | 1" | 1-1/8" | 1-1/4" | 1-1/2" |
| 3/4 | -307 | -442 | -487 | | | | | | | | | | |
| 1 | -309 | -444 | -489 | -534 | -579 | -623 | | | | | | | |
| 1-1/4 | -311 | -446 | -491 | -536 | -581 | -670 | | | | | | | |
| 1-1/2 | -313 | -448 | -493 | -538 | -583 | -627 | -672 | -714 | | | | | |
| 1-3/4 | -315 | -450 | -495 | -540 | -585 | -674 | -716 | | | | | | |
| 2 | -316 | -451 | -496 | -541 | -586 | -630 | -675 | -717 | -762 | | | | |
| 2-1/4 | | | | -542 | -587 | -676 | -718 | -763 | | | | | |
| 2-1/2 | -318 | -453 | -498 | -543 | -588 | -632 | -677 | -719 | -764 | -805 | | | |
| 2-3/4 | | | | | | | | | | | | | |
| 3 | | -455 | -500 | -545 | -590 | -634 | -679 | -721 | -766 | -807 | -847 | -887 | |
| 3-1/2 | | -457 | -502 | -547 | -592 | -636 | -681 | -723 | -768 | -809 | -849 | -889 | |
| 4 | | | -504 | -549 | -594 | -638 | -683 | -725 | -770 | -811 | -851 | -891 | -961 |
| 4-1/2 | | | | | -595 | | -684 | -726 | -771 | -812 | -852 | -892 | |
| 5 | | | | | -596 | | -685 | -727 | -772 | -813 | -853 | -893 | -963 |
| 5-1/2 | | | | | | | -686 | -728 | -773 | -814 | | | |
| 6 | | | | | -599* | | -688 | -730 | -775 | -816 | -856 | -896 | -966 |
| 6-1/2 | | | | | | | -698 | -731 | -776 | -817 | | | |
| 7 | | | | | -601* | | -690 | -732 | -777 | -818 | -858 | -898 | -968 |
| 8 | | | | | -603* | | -692 | -734 | -779 | -820 | -860 | -900 | -970 |
| Head Width Across Flats | 7/16 | 1/2 | 9/16 | 5/8 | 3/4 | 13/16 | 15/16 | 1-1/8 | 1-5/16 | 1-1/2 | 1-11/16 | 1-7/8 | 2-1/4 |
| 1* Head Height | 3/16 | 15/64 | 9/32 | 21/64 | 3/8 | 25/64 | 27/64 | 33/64 | 39/64 | 43/64 | 49/64 | 55/64 | 1-1/32 |
| Std. Packages | 100 | 100 | 100 | 50 | 50*25 | 25 | 25 | 20 | 20*10 | 20*10 | As Required | | |

papcolloy HEXAGON NUTS

097
UNC
Coarse

- MADE TO DEVELOP THE FULL STRENGTH OF 'PAPCOLLOY' CAP SCREWS
- HIGH CARBON HEAT TREATED NUTS
- GOLD ZINC DICHROMATE PLATED



- EXTRA THICKNESS FOR STRENGTH AND WRENCH ENGAGEMENT*
- BOTH UNC AND UNF THREAD SERIES

098
UNF
Fine

| Diameter | 1/4 | 5/16 | 3/8 | 7/16 | 1/2 | 9/16 | 5/8 | 3/4 | 7/8 | 1" | 1-1/8" | 1-1/4" | 1-1/2" |
|----------------------|---------|---------|---------|---------|---------|---------|---------|---------|---------|---------|---------|---------|---------|
| Stock No. UNC Coarse | 097-014 | 097-016 | 097-018 | 097-020 | 097-022 | 097-023 | 097-024 | 097-026 | 097-028 | 097-030 | 097-032 | 097-034 | 097-038 |
| Stock No. UNF Fine | 098-014 | 098-016 | 098-018 | 098-020 | 098-022 | 098-023 | 098-024 | 098-026 | 098-028 | 098-030 | 098-032 | 098-034 | 098-038 |
| Across Flats | 7/16 | 1/2 | 9/16 | 11/16 | 3/4 | 7/8 | 15/16 | 1-1/8 | 1-5/16 | 1-1/2 | 1-11/16 | 1-7/8 | 2-1/4 |
| * Thickness | .264 | .309 | .377 | .445 | .511 | .575 | .655 | .762 | .882 | 1.018 | 1.176 | 1.272 | 1.526 |
| Std. Pkgs. | 100 | 100 | 100 | 50 | 50 | 25 | 25 | 20 | 20 | 20 | 15 | 15 | 10 |



papcolloy TENSION WASHERS

Heat treated, high carbon, plated steel washers. Use two with each "Papcolloy" cap screw and nut to complete the system.

| Bolt Diameter | 1/4 | 5/16 | 3/8 | 7/16 | 1/2 | 9/16 | 5/8 | 3/4 | 7/8 | 1" | 1-1/8" | 1-1/4" | 1-1/2" |
|---------------|---------|---------|---------|---------|---------|---------|---------|---------|---------|---------|---------|---------|---------|
| Stock No. | 101-114 | 101-116 | 101-118 | 101-120 | 101-122 | 101-123 | 101-124 | 101-126 | 101-128 | 101-130 | 101-132 | 101-134 | 101-138 |
| I.D. | 9/32 | 11/32 | 13/32 | 15/32 | 17/32 | 19/32 | 11/16 | 13/16 | 15/16 | 1-1/8 | 1-1/4 | 1-3/8 | 1-5/8 |
| O.D. | 5/8 | 11/16 | 13/16 | 59/64 | 1-1/16 | 1-3/16 | 1-5/16 | 1-15/32 | 1-3/4 | 2 | 2-1/4 | 2-1/2 | 3 |
| Max.Thickness | .080 | .080 | .080 | .080 | .177 | .177 | .177 | .177 | .177 | .177 | .177 | .177 | .177 |
| Std. Pkg. | 100 | 100 | 100 | 100 | 50 | 50 | 50 | 40 | 40 | 40 | 20 | 20 | 20 |



papcolloy GRADE C STOVER® LOCKNUTS ECROUS A BLOCAGE `STOVER`®

The Stover® Locknut is an improved ONE-PIECE-REUSABLE-PREVAILING TORQUE locknut of superior locking characteristics which are obtained by accurately modifying the threads in the locking section. Grade 'C' Heat Treated High Strength Stover® Locknuts are made for critical applications. Cadmium Plated and Waxed.

Medium Carbon Steel, Heat Treated



Two sectors of the Stover® Locknut are pre-formed inwardly. When the nut is applied to the bolt, these deflected threads are elastically returned to a circular form and create an inward and downward pressure which produces intimate contact between the load carrying flanks of the nut and bolt threads. The Stover® nut starts freely and then requires wrenching as the out-of-round gripping threads engage the bolt. The prevailing torque enables the stop nut to remain in a fixed position through a wide adjustment range and it retains its locking ability through many reuses.

063
UNC
Coarse

Proof Stress:
150,000 psi.

064
UNF
Fine

Grade 'C'
identified by
eight raised dots.



Order by Stock Number

| 063-UNC Thread | | 064-UNF Thread | | Standard Package | Width 'A' x Thickness 'B' |
|----------------|---------|----------------|---------|------------------|---------------------------|
| Stock No. | Size | Height | Width | | |
| 063-014 | 1/4-20 | 064-014 | 1/4-28 | 100 | 7/16 x .226 |
| 063-016 | 5/16-18 | 064-016 | 5/16-24 | 100 | 1/2 x .273 |
| 063-018 | 3/8-16 | 064-018 | 3/8-24 | 100 | 9/16 x .337 |
| 063-020 | 7/16-14 | 064-020 | 7/16-20 | 50 | 11/16 x .385 |
| 063-022 | 1/2-13 | 064-022 | 1/2-20 | 50 | 3/4 x .448 |
| 063-023 | 9/16-12 | 064-023 | 9/16-18 | 25 | 7/8 x .496 |
| 063-024 | 5/8-11 | 064-024 | 5/8-18 | 25 | 15/16 x .559 |
| 063-026 | 3/4-10 | 064-026 | 3/4-16 | 20 | 1-1/8 x .665 |
| 063-028 | 7/8-9 | 064-028 | 7/8-14 | 20 | 1-5/16 x .776 |
| 063-030 | 1"-8 | 064-030 | 1"-14 | 20 | 1-1/2 x .887 |

Used with Grade 5 or Grade 8 Bolts.

Grade 'C' Stover® Locknuts are identified by eight raised dots and are suitable for use with heat treated high carbon and alloy steel bolts including S.A.E. Grade 8. The Cadmium finish resists rust and the pre-lubricant wax coating produces a uniform clamping force.

papcolloy LOCK WASHERS RONDELLES RESORT

EXTRA DUTY

4037 HIGH ALLOY STEEL

101
Series

For use with Grade 5, 8 or 9 bolts and for high load applications.

Mechanical Gold Zinc Dichromate Plated.

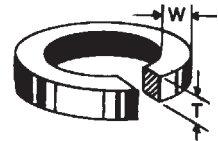

Order by Stock Number

| Stock No. | Bolt Size | Std. Pkg. | Steel Section W x T | Stock No. | Bolt Size | Std. Pkg. | Steel Section W x T |
|-----------|-----------|-----------|---------------------|-----------|-----------|-----------|---------------------|
| 101-014 | 1/4 | 100 | .109 x .062 | 101-026 | 3/4 | 40 | .234 x .188 |
| 101-016 | 5/16 | 100 | .125 x .078 | 101-028 | 7/8 | 40 | .266 x .219 |
| 101-018 | 3/8 | 100 | .141 x .094 | 101-030 | 1" | 40 | .297 x .250 |
| 101-020 | 7/16 | 100 | .156 x .109 | 101-032 | 1-1/8 | 20 | .411 x .375 |
| 101-022 | 1/2 | 50 | .171 x .125 | 101-034 | 1-1/4 | 20 | .452 x .417 |
| 101-023 | 9/16 | 50 | .188 x .141 | 101-038 | 1-1/2 | 20 | .526 x .496 |
| 101-024 | 5/8 | 50 | .203 x .156 | | | | |

Papco® GRADE B STOVER® LOCKNUTS ECROUS A BLOCAGE `STOVER®`



Low Carbon Steel

Grade 'B' Stover® Locknuts are all steel one piece construction. Lock in any position - are strong, shock-proof and vibration-proof. Easily installed and reusable - starts freely and then requires wrenching as the out-of-round gripping threads engage the bolt. Cadmium plated to resist rust and wax coated to ensure a uniform clamping force.

061
UNC
Coarse

Proof Stress:
120,000 psi.

062
UNF
Fine

Grade 'B'
identified by
five raised dots.

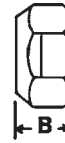

Order by Stock Number

| 061-UNC Thread | | 062-UNF Thread | | Standard Package | Width 'A' x Thickness 'B' |
|----------------|---------|----------------|---------|------------------|---------------------------|
| Stock No. | Size | Height | Width | | |
| 061-014 | 1/4-20 | 062-014 | 1/4-28 | 100 | 7/16 x .257 |
| 061-016 | 5/16-18 | 062-016 | 5/16-24 | 100 | 1/2 x .302 |
| 061-018 | 3/8-16 | 062-018 | 3/8-24 | 100 | 9/16 x .377 |
| 061-020 | 7/16-14 | 062-020 | 7/16-20 | 50 | 11/16 x .430 |
| 061-022 | 1/2-13 | 062-022 | 1/2-20 | 50 | 3/4 x .510 |
| 061-023 | 9/16-12 | 062-023 | 9/16-18 | 25 | 7/8 x .555 |
| 061-024 | 5/8-11 | 062-024 | 5/8-18 | 25 | 15/16 x .645 |
| 061-026 | 3/4-10 | 062-026 | 3/4-16 | 20 | 1-1/8 x .750 |
| 061-028 | 7/8-9 | 062-028 | 7/8-14 | 20 | 1-5/16 x .862 |
| 061-030 | 1"-8 | 062-030 | 1"-14 | 20 | 1-1/2 x .958 |

Used with Grade 2 or Grade 5 Bolts.



STOVER® LOCKNUT ASSORTMENTS

These Assortments contain 90 lock nuts from 1/4" to 1/2" diameter. The container is sectionally divided for ease of selection.

UTILITY ASSORTMENT No. 020-348
Fine Thread (UNF) STOVER® LOCKNUTS

UTILITY ASSORTMENT No. 020-349
Coarse Thread (UNC) STOVER® LOCKNUTS

118
Series

Papco®

FLANGE NUTS ECROUS DE REBORD

BRIGHT ZINC PLATED

'Papco' Flange Nuts provide better load distribution in fastening metal parts, wood or other soft materials. The flange bridges an oversize or elongated hole and eliminates the need for washers.

Two styles:

(A) TENSILOCK - one-piece, hardened, free running lock nuts have ratchet teeth in their base - bite into surface and hold tight under vibration.

(B) STANDARD - in regular and large flange (L) patterns.



Standard

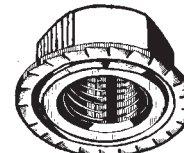

Tensilock

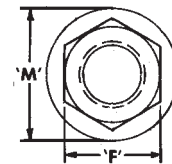

Order by Stock Number

Standard Package 100 Nuts.

| Stock No. | | Thread Size | Dimensions | | |
|-----------|----------|-------------|------------|-----------|------------|
| Tensilock | Standard | | Hex 'F' | Thick 'H' | Flange 'M' |
| 118-014 | 118-114 | 1/4-20 | 7/16 | 15/64 | 19/32 |
| 118-016 | 118-116 | 5/16-18 | 1/2 | 9/32 | 43/64 |
| | 118-117 | 5/16-18 L | 1/2 | 23/64 | 13/16 |
| 118-018 | 118-118 | 3/8-16 | 9/16 | 11/32 | 47/64 |
| | 118-119 | 3/8-16 L | 9/16 | 25/64 | 29/32 |
| | 118-120 | 7/16-14 | 11/16 | 25/64 | 59/64 |
| 118-022 | 118-122 | 1/2-13 | 3/4 | 29/64 | 1-1/64 |

GARAGE ASSORTMENT No. 020-053

Contains 50 locking flange nuts, five sizes from 1/4-20 to 1/2-13. Packed in a clear plastic box. Useful in many repairs where a flange nut is needed.





108
UNC
Coarse

109
UNF
Fine

papeo

'POZI-LOK'® STOP NUTS
ECROUS 'POZI-LOK'®



NYLON INSERT

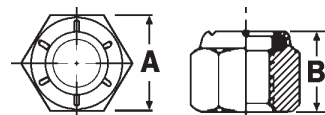

These prevailing torque locknuts offer excellent vibration resistance and a wide range of adjustment. The nylon collar prevents liquid seepage and internal corrosion. It is smaller than the bolt diameter and as the bolt enters the collar, the thread form is impressed in the nylon. The resulting compressive forces exert constant friction grip on the bolt and prevent loosening. These nuts may be re-used up to 50 times because the "elastic memory" feature of the nylon causes it to return to its original shape. May be used with Grade 2 and Grade 5 Screws up to 250° F. Bright zinc chromate plated.

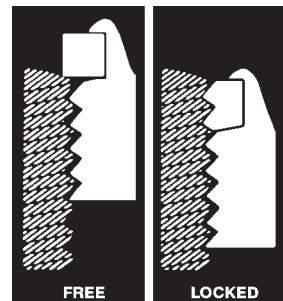

Order by Stock Number

| UNC COARSE THREAD | | UNF FINE THREAD | | Standard Packages | Dimensions | |
|-------------------|---------|-----------------|---------|-------------------|------------|---------------|
| Stock No. | Size | Stock No. | Size | | "A" Width | "B" Thickness |
| 108-006 | 6-32 | | | 100 | 5/16 | .178 |
| 108-008 | 8-32 | | | 100 | 11/32 | .229 |
| 108-010 | 10-24 | 109-010 | 10/32 | 100 | 3/8 | .239 |
| 108-014 | 1/4-20 | 109-014 | 1/4-28 | 100 | 7/16 | .313 |
| 108-016 | 5/16-18 | 109-016 | 5/16-24 | 100 | 1/2 | .344 |
| 108-018 | 3/8-16 | 109-018 | 3/8-24 | 100 | 9/16 | .453 |
| 108-020 | 7/16-14 | 109-020 | 7/16-20 | 50 | 5/8 | .453 |
| 108-022 | 1/2-13 | 109-022 | 1/2-20 | 50 | 3/4 | .594 |
| 108-023 | 9/16-12 | 109-023 | 9/16-18 | 25 | 7/8 | .641 |
| 108-024 | 5/8-11 | 109-024 | 5/8-18 | 25 | 15/16 | .750 |
| 108-026 | 3/4-10 | 109-026 | 3/4-16 | 20 | 1-1/16 | .875 |
| 108-028 | 7/8-9 | 109-028 | 7/8-14 | 20 | 1-1/4 | .984 |
| 108-030 | 1-8 | 109-030 | 1-14 | 20 | 1-7/16 | 1.047 |



papeo

'POZI-LOK'® STOP NUT ASSORTMENTS
ASSORTIMENTS ECROUS 'POZI-LOK'®

MASTER ASSORTMENT
No. 020-649

This assortment contains 175 nuts in 16 sizes from 1/4" to 3/4" in both Coarse and Fine Thread. Packed in sturdy, metal box with moulded plastic compartments. Illustrated lid label includes retail price codes.

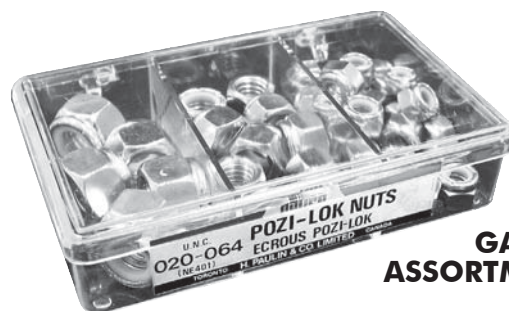

GARAGE ASSORTMENTS

No. 020-064 UNC Coarse Thread
No. 020-065 UNF Fine Thread
Each contains 40 plated 'Pozi-Lok' Stop Nuts 1/4, 5/16, 3/8, 7/16 and 1/2 diameter. Packed in a clear plastic box.

106
Series

papeo

PANEL NUTS
ECROUS A PANNEAU



Precision made steel and brass thin nuts for volume controls on radios, chassis connections, toggle switches etc. Five popular sizes available.

Order by Stock Number

Standard Package 25 Pieces

| Stock No. | Size and Description | Stock No. | Size and Description |
|-----------|--------------------------|-----------|---------------------------|
| 106-914 | 1/4-32 Brass | 106-920 | 7/16-28 Zinc Plated Steel |
| 106-916 | 3/8-24 Zinc Plated Steel | 106-922 | 1/2-28 Zinc Plated Steel |
| 106-918 | 3/8-32 Zinc Plated Steel | | |

papco® DOUBLE THICKNESS NUTS ECROUS TRES HAUT

(Light High Nuts)

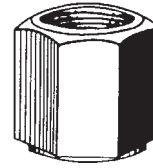

102
Series

"Papco" Double Nuts are used on spring centre bolts, spring "U" bolts, heavy duty truck wheels, tractor and implement bolts.
All Double Thickness Nuts have UNF (S.A.E.) Fine Threads

Order by Stock Number

Standard Package 24 pieces (* 12 pieces)

| Stock No. | Size | Height | Width | Stock No. | Size | Height | Width |
|-----------|---------|--------|-------|-----------|----------|---------|---------|
| 102-018 | 3/8-24 | 17/32 | 9/16 | 102-026 | 3/4-16 | 1" | 1-1/16 |
| 102-020 | 7/16-20 | 39/64 | 5/8 | 102-027 | 3/4-16 | 1" | 1-1/8 |
| 102-022 | 1/2-20 | 11/16 | 3/4 | *102-028 | 7/8-14 | 1-5/32 | 1-1/4 |
| 102-023 | 9/16-18 | 49/64 | 7/8 | *102-030 | 1-14 | 1-5/16 | 1-7/16 |
| 102-024 | 5/8-18 | 27/32 | 15/16 | *102-034 | 1 1/4-12 | 1-11/16 | 1-13/16 |

For Spring Centre Bolts see page 113.

103
Series

papco® WING NUTS ECROUS A OREILLE

Strong, well-finished nuts made of cold forged steel. Feature recessed wings for good finger grip. Bright, rust-resistant finish.



Order by Stock Number

Standard Package contains 50 pieces

| Size | 10-24 | 1/4-20 | 5/16-18 | 3/8-16 | 7/16-14 | 1/2-13 |
|-----------|---------|---------|---------|---------|---------|---------|
| Stock No. | 103-010 | 103-014 | 103-016 | 103-018 | 103-020 | 103-022 |

For Air Cleaner Wing Nuts see page 124.



No. 020-310

WING NUT UTILITY ASSORTMENT No. 020-310

Contains 151 Wing Nuts in five popular sizes. Sturdy fibreboard display box, ideal for Automotive and Hardware use. Each size in an individual compartment.

papco® ACORN (CAP) NUTS ECROUS BORGNE A CALOTTE

104
Series

Durable, smooth-finished Cap Nuts
Zinc Alloy, Bright Nickel Plated or Zinc Plated Steel

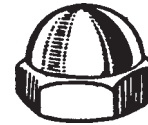

Order by Stock Number

| Zinc Alloy Stock No. | Steel Stock No. | Size and Thread | Std. Pkg. | Zinc Alloy Stock No. | Steel Stock No. | Size and Thread | Std. Pkg. |
|----------------------|-----------------|-----------------|-----------|----------------------|-----------------|-----------------|-----------|
| 104-006 | 104-106 | 6-32 | 100 | 104-016 | 104-116 | 5/16-18 | 100 |
| 104-008 | 104-108 | 8-32 | 100 | 104-017 | — | 5/16-24 | 100 |
| 104-010 | 104-110 | 10-24 | 100 | 104-018 | 104-118 | 3/8-16 | 100 |
| 104-011 | 104-111 | 10-32 | 100 | 104-019 | — | 3/8-24 | 100 |
| 104-014 | 104-114 | 1/4-20 | 100 | 104-022 | — | 1/2-13 | 100 |
| 104-015 | — | 1/4-28 | 100 | | | | |

ACORN (CAP) NUT UTILITY ASSORTMENT No. 020-336

Contains 87 Acorn Nuts in the following popular sizes:
6-32, 8-32, 10-24, 1/4-20, 5/16-18, 3/8-16, 1/2-13.
Each size is in an individual compartment in a sturdy fibreboard box.



No. 020-336



papco® 'POZI-LOK'® DOUBLE NUTS ECROUS TRES HAUT 'POZI-LOK'®

111
Series

These Nylon Insert, prevailing torque lock nuts offer excellent vibration resistance and assure positive locking under sever shock. Used for Spring Centre Bolts. Spring U-Bolts etc. UNF Fine Thread.

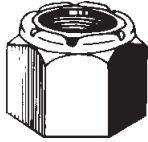

Order by Stock Number

Standard Package 5 pieces

| Stock No. | Size | Dimensions | |
|-----------|---------|------------|---------------|
| | | Width "A" | Thickness "B" |
| 111-018 | 3/8-24 | 35/64 | 41/64 |
| 111-020 | 7/16-20 | 5/8 | 49/64 |
| 111-022 | 1/2-20 | 3/4 | 13/16 |
| 111-024 | 5/8-18 | 15/16 | 1" |

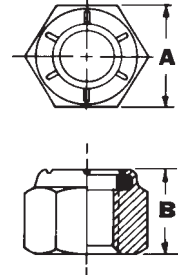

112
Series

papco® 'UNI-NUT'® ALL-NYLON LOCK NUTS ECROUS A BLOCAGE NYLON 'UNI-NUT'®

Can be used with any thread design.

Self-Tapping - Self-Locking

ONE NUT FITS ANY TYPE OF SCREW THREAD

One piece washer base Hexagon prevailing torque Nylon Lock Nuts. These nuts lock against sever vibration - at any point on the screw thread - are rust-proof and electrical insulating - can be re-used. 'Papco' Uni-Nuts will fit Fine and Coarse threads, British, Metric and spaced thread screws. Useful in emergencies.

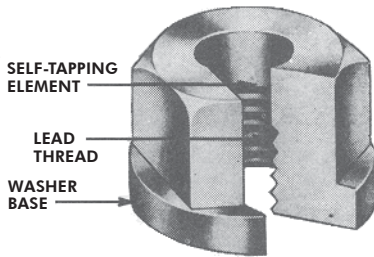

Order by Stock Number

Standard Package 100 pieces

| Stock No. | Screw or Bolt Size | Width Across Flats | Width Across Washer | Overall Height |
|-----------|--------------------|--------------------|---------------------|----------------|
| 112-004 | No. 4 | 1/4 | .275-.289 | 11/64 |
| 112-006 | No. 6 | 5/16 | .344-.361 | 13/64 |
| 112-008 | NO. 8 | 11/32 | .378-.397 | 15/64 |
| 112-010 | No. 10 | 3/8 | .413-.434 | 1/4 |
| 112-014 | No. 14 (1/4") | 7/16 | .482-.506 | 9/32 |
| 112-016 | 5/16" | .555 | .635 | .330 |
| 112-018 | 3/8" | .610 | .710 | .405 |

GARAGE ASSORTMENTS No. 020-066



Contains 45 Nylon Lock Nuts sizes No. 4 to 3/8". Packed in clear plastic container.

119
Series

papco® 'KEPS' LOCKNUT ASSEMBLIES ECROUS A BLOCAGE 'KEPS'



Consists of a pre-assembled hexagon nut and a tooth lock washer. The tapered, twisted locking teeth provide full locking action when the nut is seated. American Standard Machine Screw Sizes. Bright Plated.

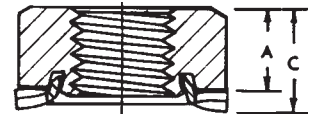

Order by Stock Number

Standard Package 100 Pieces

| Stock No. | Keps Nut Size | Width Across Flats | Overall Thickness (C) | Nut Thickness (A) |
|-----------|---------------|--------------------|-----------------------|-------------------|
| 119-006 | 6-32 | 5/16 | 9/64 | 7/64 |
| 119-008 | 8-32 | 11/32 | 5/32 | 1/8 |
| 119-010 | 10-24 | 3/8 | 5/32 | 1/8 |
| 119-011 | 10-32 | 3/8 | 5/32 | 1/8 |
| 119-014 | 1/4-20 | 7/16 | 15/64 | 3/16 |
| 119-015 | 1/4-28 | 7/16 | 15/64 | 3/16 |
| 119-016 | 5/16-18 | 1/2 | 11/32 | 9/32 |
| 119-018 | 3/8-16 | 9/16 | 7/16 | 3/8 |

GARAGE ASSORTMENTS No. 020-055

This Assortment contains 75 'KEPS' Locknuts in each of the sizes listed. Packed in a sturdy four-compartment clear plastic box with a hinged lid.

129
Series

papco

**PLATED CARRIAGE BOLTS
BOULONS DE CARROSSE PLAQUE**

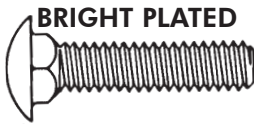

Used extensively for Truck Rack and Floor-board construction or repair. Fully threaded for proper fit and adjustment in wood.

Order by Stock Number

| Length Overall | Bolt Diameter | | | | | | | |
|----------------|---------------|-----------|---------|-----------|---------|-----------|---------|-----------|
| | 1/4 | Std. Pkg. | 5/16 | Std. Pkg. | 3/8 | Std. Pkg. | 1/2 | Std. Pkg. |
| 3/4 | 129-307 | 100 | 129-442 | 100 | 129-487 | 100 | | |
| 1 | 129-309 | 100 | 129-444 | 100 | 129-489 | 100 | 129-579 | 50 |
| 1-1/4 | 129-311 | 100 | 129-446 | 100 | 129-491 | 100 | 129-581 | 50 |
| 1-1/2 | 129-313 | 100 | 129-448 | 100 | 129-493 | 100 | 129-583 | 50 |
| 2 | 129-316 | 100 | 129-451 | 100 | 129-496 | 100 | 129-586 | 50 |
| 2-1/2 | 129-318 | 100 | 129-453 | 100 | 129-498 | 100 | 129-588 | 50 |
| 3 | 129-320 | 100 | 129-455 | 100 | 129-500 | 100 | 129-590 | 50 |
| 3-1/2 | 129-322 | 100 | 129-457 | 100 | 129-502 | 100 | 129-592 | 50 |
| 4 | 129-324 | 100 | 129-459 | 100 | 129-504 | 100 | 129-594 | 50 |
| 4-1/2 | 129-325 | 100 | 129-460 | 100 | 129-505 | 100 | 129-595 | 50 |
| 5 | 129-326 | 100 | 129-461 | 100 | 129-506 | 50 | 129-596 | 25 |
| 6 | 129-329 | 100 | 129-464 | 50 | 129-509 | 50 | 129-599 | 25 |
| 8 | | | | | 129-513 | 50 | 129-603 | 25 |
| 10 | | | | | 129-517 | 10 | 129-607 | 10 |
| 12 | | | | | 129-520 | 10 | 129-610 | 10 |

Note: Plated Grade 5 Carriage Bolts are available. See current price list. Full shank Carriage Bolts available upon request.



papco CARRIAGE BOLT

UTILITY ASSORTMENT No. 020-330

This Assortment contains 70 Plated Bolts and Nuts, 14 sizes. Each size in a compartment in a sturdy fibre-board container with retail prices shown. Particularly useful for farm, garage and general repair work.

133
Series

papco

**PLATED GRADE 5 PLOW BOLTS
BOULONS DE CHARRUE CLASSE 5 PLAQUE**



- HIGH CARBON STEEL
- DOUBLE HEAT TREATED

'Papco' Plow Bolt heads are round, countersunk with a square neck. Oversize heads for 3/8 dia. are 7/16 dia. head and 7/16 dia. is 1/2 dia. head. Length is measured overall from end of bolt to the top of the head. Other heads and styles are available.

Order by Stock Number

Standard Packages: 3/8" dia. 100; 7/16" and 1/2" dia. 50; 5/8" dia. 25

| Length Overall | STANDARD HEAD | | | | OVERSIZE HEAD | |
|----------------|---------------|---------|---------|---------|---------------|---------|
| | 3/8 | 7/16 | 1/2 | 5/8 | 3/8 | 7/16 |
| 1 | 133-489 | 133-534 | — | — | — | — |
| 1-1/4 | 133-491 | 133-536 | 133-581 | — | 133-791 | — |
| 1-1/2 | 133-493 | 133-538 | 133-583 | 133-672 | 133-793 | — |
| 1-3/4 | 133-495 | 133-540 | 133-585 | 133-674 | 133-795 | 133-816 |
| 2 | 133-496 | 133-541 | 133-586 | 133-675 | — | 133-820 |
| 2-1/4 | — | — | — | 133-676 | — | 133-822 |
| 2-1/2 | 133-498 | 133-543 | 133-588 | 133-677 | — | 133-824 |
| 3 | — | 133-545 | 133-590 | 133-679 | — | — |

Note: 'Papco' Dome Head Scraper (Blade) Bolts, made to S.A.E. Grade 8 Specs. are available in 5/8, 3/4, 7/8, 1" Diameters.



135
Series

papco PLATED LAG BOLTS
TIRE-FOND PLAQUE

Hex Head



Sharp Gimlet Point

Order by Stock Number

Standard Packages = 100, *50, **25.

| DIA. LENGTH | 1/4 | 5/16 | 3/8 | 1/2 |
|-------------|---------|---------|----------|-----------|
| 1 | 135-309 | 135-444 | | |
| 1-1/4 | 135-311 | 135-446 | | |
| 1-1/2 | 135-313 | 135-448 | 135-493 | |
| 2 | 135-316 | 135-451 | 135-496 | *135-586 |
| 2-1/2 | 135-318 | 135-453 | 135-498 | *135-588 |
| 3 | 135-320 | 135-455 | 135-500 | *135-590 |
| 3-1/2 | 135-322 | 135-457 | 135-502 | *135-592 |
| 4 | 135-324 | 135-459 | 135-504 | *135-594 |
| 4-1/2 | 135-325 | 135-460 | 135-505 | *135-595 |
| 5 | 135-326 | 135-461 | *135-506 | *135-596 |
| 6 | 135-329 | 135-464 | *135-509 | **135-599 |
| 7 | — | — | *135-511 | **135-601 |
| 8 | — | — | *135-513 | **135-603 |

Length of Lag Bolt is measured from under head to end of point.

Thread is one-half of length plus 1/2".

Larger and longer sizes are available.

papco LAG BOLT SHIELDS
CHEVILLES POUR TIRE-FONDS



Papco Lag Shields are a screw type anchor designed to be used with Lag Screws. Short type shields are used in harder masonry materials to reduce drilling time. The Long version is used in soft masonry to develop better holding strength. For use in concrete or mortar joints of brick or block walls.

Order by Stock Number

| Lag Screw | 1/4" | | 5/16" | | 3/8" | | 1/2" | |
|------------|---------|---------|---------|---------|---------|---------|---------|---------|
| Length | 1" | 1-1/2" | 1-1/4" | 1-3/4" | 1-3/4" | 2-1/2" | 2" | 3" |
| Stock No. | 135-801 | 135-803 | 135-805 | 135-807 | 135-809 | 135-811 | 135-813 | 135-815 |
| Drill Hole | 1/2" | 1/2" | 1/2" | 1/2" | 5/8" | 5/8" | 3/4" | 3/4" |
| Std. Pkg. | 25 | 25 | 25 | 15 | 20 | 10 | 10 | 10 |

For Masonry Drill Bits see page 176.

136
Series

papco SQUARE HEAD SET SCREWS
VIS DE PRESSION A TETE CARREE

Case Hardened,
Cup Point

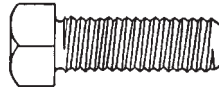

Coarse Thread
(UNC)

| Stock No. | Size | Stock No. | Size | Stock No. | Size | Stock No. | Size | Stock No. | Size |
|------------|-------------|-----------|--------------|-----------|-------------|-----------|--------------|-----------|-------------|
| 136-303 | 1/4 x 3/8 | 136-440 | 5/16 x 1/2 | 136-485 | 3/8 x 1/2 | 136-532 | 7/16 x 3/4 | 136-577 | 1/2 x 3/4 |
| 136-305 | 1/4 x 1/2 | 136-442 | 5/16 x 3/4 | 136-487 | 3/8 x 3/4 | 136-534 | 7/16 x 1 | 136-579 | 1/2 x 1 |
| 136-307 | 1/4 x 3/4 | 136-444 | 5/16 x 1 | 136-489 | 3/8 x 1 | 136-536 | 7/16 x 1-1/4 | 136-581 | 1/2 x 1-1/4 |
| 136-309 | 1/4 x 1 | 136-446 | 5/16 x 1-1/4 | 136-493 | 3/8 x 1-1/2 | 136-538 | 7/16 x 1-1/2 | 136-583 | 1/2 x 1-1/2 |
| 136-313 | 1/4 x 1-1/2 | 136-448 | 5/16 x 1-1/2 | 136-496 | 3/8 x 2 | 136-541 | 7/16 x 2 | 136-586 | 1/2 x 2 |
| Std. Pkgs. | 100 | 100 | 100 | 100 | 50 | 50 | 50 | 50 | |

The length of a square head set screw is measured from under the head to the extreme point.

Screws are threaded entire length of the body.

GARAGE ASSORTMENT No. 020-046

Contains 35 Square Head Set Screws in 10 sizes. Packed in transparent plastic box with hinged lid.

MASTER ASSORTMENT No. 020-636

This assortment contains 82 screws, 20 popular sizes, and is packed in a sturdy, metal sectional divided box.

The hinged lid contains an illustrated label with resale prices. Container has locking handle.

UTILITY ASSORTMENT No. 020-344

This assortment contains 66 Square Head Set Screws, 10 popular sizes: 1/4 x 1/2", 5/16 x 3/4", 1", 1-1/2"; 3/8 x 3/4", 1-1/2"; 1/2 x 1", 2".

Packed in a sturdy fibreboard container. The lid label is illustrated and shows retail prices.

papeco SOCKET HEAD CAP SCREWS BOULONS DE PRESSION



137
UNC
Coarse

'Papco' Socket Cap Screws are made from Alloy Steel and have a tensile strength of 165,000 p.s.i. Sizes listed are Coarse Thread, UNC. Additional sizes are available.

Alloy Steel

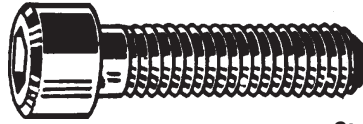

High Strength

Order by Stock Number

Standard Package contains 25 Screws

| Stock No. | Size Dia. x Length | Use Wrench No. | Stock No. | Size Dia. x Length | Use Wrench No. |
|-----------|--------------------|----------------|-----------|--------------------|----------------|
| 137-305 | 1/4-20 X 1/2 | 140-108 | 137-487 | 3/8-16 X 3/4 | 140-111 |
| 137-307 | 3/4 | | 137-489 | 1 | |
| 137-309 | 1 | | 137-491 | 1-1/4 | |
| 137-311 | 1-1/4 | | 137-493 | 1-1/2 | |
| 137-313 | 1-1/2 | | 137-495 | 1-3/4 | |
| 137-315 | 1-3/4 | | 137-496 | 2 | |
| 137-316 | 2 | | 137-498 | 2-1/2 | |
| 137-442 | 5/16-18 x 3/4 | 140-110 | 137-583 | 1/2-13 x 1-1/2 | 140-112 |
| 137-444 | 1 | | 137-586 | 2 | |
| 137-446 | 1-1/4 | | 137-588 | 2-1/2 | |
| 137-448 | 1-1/2 | | | | |
| 137-450 | 1-3/4 | | | | |
| 137-451 | 2 | | | | |



papeco SOCKET HEAD CAP SCREW ASSORTMENT

UTILITY ASSORTMENT No. 020-328

This Assortment contains 36 Socket Head Cap Screws, 12 popular sizes from 1/4 x 3/4 to 1/2 x 2-1/2 coarse thread. Each size is in an individual compartment in a sturdy fibre-board container.

papeco SOCKET SET SCREWS VIS DE PRESSION

138
UNC
Coarse



'Papco' Socket Set Screws are made from heat treated Alloy Steel and have ground threads. Sizes listed are standard cup point.



139
UNF
Fine

Order by Stock Number

Standard Package contains 25 Screws

| Stock No. | Size Dia. x Length | Use Wrench No. | Stock No. | Size Dia. x Length | Use Wrench No. | Stock No. | Size Dia. x Length | Use Wrench No. |
|-----------|--------------------|----------------|-----------|--------------------|----------------|----------------|--------------------|----------------|
| UNC | | | 138-186 | 10-24 x 5/16 | 140-103 | 138-575 | 1/2-13 x 1/2 | 140-110 |
| | | | 138-187 | 3/8 | | 138-576 | 5/8 | |
| 138-081 | 6-32 x 1/8 | 140-101 | 138-301 | 1/4-20 x 1/4 | 140-104 | 138-665 | 5/8-11 x 5/8 | 140-111 |
| 138-082 | 3/16 | | 138-302 | 5/16 | | UNF | | |
| 138-083 | 1/4 | | 138-303 | 3/8 | | 139-184 | 10-32 x 3/16 | 140-103 |
| 138-130 | 8-32 x 1/8 | 140-102 | 138-305 | 1/2 | 139-185 | 1/4 | | |
| 138-132 | 3/16 | | 138-437 | 5/16-18 x 5/16 | 139-186 | 5/16 | | |
| 138-133 | 1/4 | | 138-438 | 3/8 | 139-301 | 1/4-28 x 1/4 | 140-104 | |
| 138-134 | 5/16 | | 138-440 | 1/2 | 139-303 | 3/8 | | |
| 138-135 | 3/8 | | 138-483 | 3/8-16 x 3/8 | 139-437 | 5/16-24 x 5/16 | 140-107 | |
| 138-184 | 10-24 x 3/16 | 140-103 | 138-485 | 1/2 | 139-483 | 3/8-24 x 3/8 | 104-108 | |
| 138-185 | 1/4 | | 138-486 | 5/8 | | | | |

Note: Additional sizes of Socket Set Screws and Socket Head Cap Screws are available from Stock. For Socket Screw Assortments refer to page 42.



140
Series

papco

SOCKET SCREW KEYS
CLES DE VIS CREUX



"Papco" Socket Screw Keys are made of close tolerance alloy steel. All Keys have chamfered ends for easy insertion. These Keys are available in Short and Long Arm Series. Short Arm Series supplied unless otherwise specified.

Order by Stock Number

Standard Package contains 12 Keys

| Stock Numbers | | Hex Width Across Flats | Length of Short Arm | Length of Longer Arm | | Socket Set | FOR SCREW DIAMETER | | | | | |
|---------------|-------------|------------------------------|------------------------|----------------------|----------------|----------------|--------------------|-----------|---------------------|-----------------------|--------------------|---------------|
| Short Arm | Long Arm | | | Short Series | Long Series | | Socket Head Cap | | Flat Head Cap | Button Head Cap | Shoulder Screws | Pipe Plugs |
| | | | | | 1960 Series | 1936 Series | | | | | | |
| 140-101 | 140-201 | 1/16 | 9/16 | 1-3/4 | | #5, #6 | | #2 | #4 | #4 | | |
| 140-102 | 140-202 | 5/64 | 39/64 | 1-7/8 | 3-3/16 | #8 | #2, #3 | #3, #4 | #5, #6 | #6 | | |
| 140-103 | 140-203 | 3/32 | 21/32 | 2 | 3-3/8 | #10, #12 | #4, #5 | #5, #6 | #8 | #8 | | |
| 140-104 | 140-204 | 7/64 | 11/16 | 2-1/8 | 3-1/2 | | #6 | | | | | |
| 140-105 | 140-205 | 1/8 | 3/4 | 2-1/4 | 3-3/4 | 1/4 | | #8 | #10 | #10 | | |
| 140-106 | 140-206 | 9/64 | 13/16 | 2-3/8 | 3-7/8 | | #8 | | | | | |
| 140-107 | 140-207 | 5/32 | 27/32 | 2-1/2 | 4-1/8 | 5/16 | #10 | #10, #12 | 1/4 | 1/4 | 5/16 | 1/16 |
| 140-108 | 140-208 | 3/16 | 15/16 | 2-3/4 | 4-1/2 | 3/8 | 1/4 | 1/4 | 5/16 | 5/16 | 3/8 | 1/8 |
| 140-109 | 140-209 | 7/32 | 1-1/32 | 3 | 4-7/8 | 7/16 | | 5/16 | 3/8 | 3/8 | | |
| 140-110 | 140-210 | 1/4 | 1-1/8 | 3-1/4 | 5-1/4 | 1/2, 9/16 | | 5/16 | 7/16 | 7/16 | 1/2 | 1/4 |
| 140-111 | 140-211 | 5/16 | 1-1/4 | 3-3/4 | 6 | 5/8 | | 3/8 | 3/8, 7/16 | 1/2 | 5/8 | 3/8 |
| 140-112 | 140-212 | 3/8 | 1-3/8 | 4-1/4 | 6-3/4 | 3/4 | 7/16, 1/2 | 1/2, 9/16 | 5/8, 3/4 | 5/8 | 3/4 | 1/2 |

CARD No.
140-852
INCH

papco **SOCKET KEY SETS**
JEU DE CLES

Available in both INCH and METRIC types.
Each "Papco" Socket Key Set is individually carded.
Order by CARD NUMBER.

CARD No.
140-853
METRIC

- 7 popular size Alloy Steel Keys: .050, 1/16, 5/64, 3/32, 3/16.
- Fits Socket Set Screws: No.3 to 3/8" Dia. Socket Cap Screws: No.1 to 1/4" Dia.
- Each key folds into the sturdy steel frame — like a pocket knife blade.
- Can be used in any position.



Card No. 140-852

- 7 popular metric size Alloy Steel Keys: 1.27, 1.5, 2, 2.5, 3, 4, and 5 mm.
- Fits full range of "Papco" Metric Set Screws.
- Closes like a pocket knife when not in use.
- Can be used in any position.

Kit No. 020-858 Short Arm Keys

- Contains 7 Hexagon Alloy Steel Keys, Short Arm Series
- Hex. sizes: 5/64 • 3/32 • 1/8 • 5/32 • 3/16 • 7/32 • 1/4
- Transparent Plastic Case.
- Fit Socket Set Screws from No. 8 to 1/2" Diameter.
- Fit Socket Screws from No. 2 to 5/16" Diameter.
- A professional quality kit made from chrome alloy steel, heat treated to give the best combination of toughness and torsional strength.

(Five 020-858 kits in a master package.)



020-858

UTILITY ASSORTMENT No. 020-335

Contains 52 Keys, 9 sizes.

140 - 102 • 103 • 104 • 107
108 • 109 • 110 • 111 • 112

Packed in a sturdy fibreboard container with illustrated lid label.





SOCKET SET SCREW ASSORTMENTS ASSORTIMENTS VIS DE PRESSION



ASSORTMENT No. 020-855

- Contains 84 Socket Set Screws and 5 Hexagon Keys.
- 10 popular sizes of Set Screws:

| | | |
|----------------|--------------|--------------|
| 8-32 x 3/16 | 10-24 x 3/16 | 1/4-20 x 1/4 |
| 8-32 x 1/4 | 10-24 x 1/4 | 1/4-20 x 3/8 |
| 5/16-18 x 5/16 | 3/8-16 x 3/8 | |
| 5/16-18 x 3/8 | 3/8-16 x 1/2 | |
- Transparent Styrene Plastic Container.
- Illustrated label shows size and retail prices.
- Refills available in standard packages.

This assortment is designed for Mechanics, Refrigerator, Oil-Burner and Appliance Servicemen. The re-usable container fits any Tool Kit.



Size: 7" x 4" x 1 1/2"



UTILITY ASSORTMENT No. 020-321

Contains 120 Socket Set Screws, 12 popular sizes:

- | | | |
|----------------|----------------|--------------|
| 8-32 x 3/16 | 10-24 x 3/16 | 1/4-20 x 1/4 |
| 8-32 x 1/4 | 10-24 x 1/4 | 1/4-20 x 3/8 |
| 1/4-28 x 1/4 | 5/16-18 x 5/16 | 3/8-16 x 3/8 |
| 5/16-24 x 5/16 | 5/16-18 x 3/8 | 3/8-16 x 1/2 |

Packed in a sturdy fibre board container with a separate compartment for each size. Lid label is illustrated and shows retail prices.

MASTER ASSORTMENT No. 020-629

Contains 166 Socket Set Screws in the following sizes:
(Quantities are adjusted according to popularity)

- | | | |
|--------------|----------------|----------------|
| 8-32 x 3/16 | 10-24 x 3/16 | 3/8-16 x 3/8 |
| 8-32 x 1/4 | 10-24 x 1/4 | 1/2-13 x 1/2 |
| 1/4-20 x 1/4 | 5/16-18 x 5/16 | 10-32 x 3/16 |
| 1/4-20 x 3/8 | 5/16-18 x 3/8 | 1/4-28 x 1/4 |
| 1/4-20 x 1/2 | 5/16-18 x 1/2 | 5/16-24 x 5/16 |

Packed in a rigid all metal lidded box with illustrated lid label showing retail prices. Assortment can be refilled from standard packages.

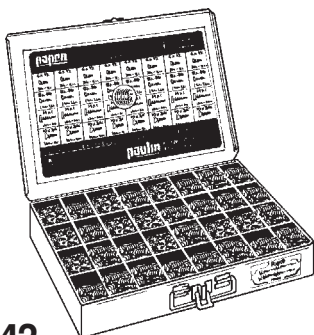

papeo SUPER SERVICE ASSORTMENT No. 020-803

Contains 240 Socket Set Screws — 32 sizes plus keys.
Large size, rigid metal box with high-strength plastic compartments.

For more details see page 9.

Large size: 12" w. x 18" l. x 3" d.



126
Series

papeco HITCH PINS GOUPILLES D'ATTELAGE

HITCH PINS with CLIPS

Designed specifically for quick hitching or unhitching of all types of towed or mobile equipment. Made from high strength, zinc plated steel. Includes Hitch Pin Clip.

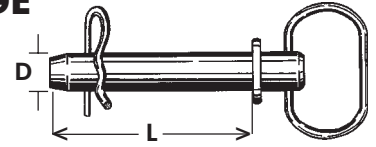

Order by Stock Number

Standard Package 5 Pieces

| Stock No. | Size 'D' x 'L' | Usable Length | Stock No. | Size 'D' x 'L' | Usable Length |
|-----------|----------------|---------------|-----------|----------------|---------------|
| 126-912 | 1/2 x 4-3/4 | 4 | 126-920 | 3/4 x 7 | 6-1/4 |
| 126-914 | 5/8 x 4-3/4 | 4 | 126-922 | 7/8 x 7-1/2 | 6-1/2 |
| 126-916 | 5/8 x 6-3/4 | 6 | 126-924 | 1" x 7-3/4 | 6-3/4 |
| 126-918 | 3/4 x 5 | 4-1/4 | | | |

papeco HITCH PINS with CHAIN and LYNCH PINS GOUPILLES D'ATTELAGE avec CHAINE et CLAVETTES

All the features of our standard Hitch Pins as described above plus the added protection of an attached 12" chain and lynch pin. All zinc plated steel.

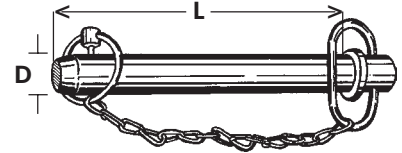

Order by Stock Number

Standard Package 3 Pieces

| Stock No. | Size 'D' x 'L' | Usable Length | Stock No. | Size 'D' x 'L' | Usable Length |
|-----------|----------------|---------------|-----------|----------------|---------------|
| 126-812 | 1/2 x 4-3/4 | 4 | 126-820 | 3/4 x 7 | 6-1/4 |
| 126-814 | 5/8 x 4-3/4 | 4 | 126-822 | 7/8 x 7-1/2 | 6-1/2 |
| 126-816 | 5/8 x 6-3/4 | 6 | 126-824 | 1" x 7-3/4 | 7 |
| 126-818 | 3/4 x 5 | 4-1/4 | | | |

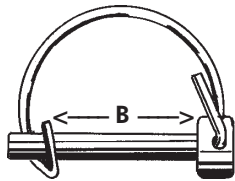

126-900
126-901

papeco WIRE LOCK PINS GOUPILLES DE VERROUILLAGE

WIRE LOCK PINS

126-902
126-906

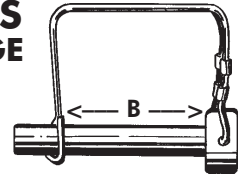

For farm, campers, trucks, boats, trailers, snowmobiles and garden equipment etc. Fits all PTO knuckles and most adaptors. Oil tempered spring remains securely snap-locked.

Order by Stock Number

Standard Package 15 Pieces

| Stock No. | Size | Usable Length 'B' | Stock No. | Size | Usable Length 'B' |
|-----------|----------|-------------------|-----------|--------------|-------------------|
| 126-900 | 1/4 x 3 | 2-3/4 | 126-902 | 5/16 x 2-3/4 | 2-1/2 |
| 126-901 | 5/16 x 2 | 1-3/4 | 126-906 | 3/8 x 2 | 1-3/4 |

126
Series

papeco LYNCH PINS CLAVETTES D'ESSIEU

LYNCH PINS Also known as 'Quick-Pins'

'Papco' Lynch Pins are heat treated to withstand wear. Spring steel snap ring assembled mechanically to eliminate stretching and loss of tension. Zinc plated to resist rust.

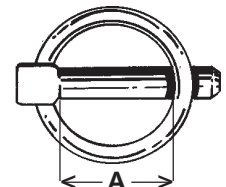

Order by Stock Number

Standard Package 15 Pieces

| Stock No. | Pin Size | 'A' Grip Length | Stock No. | Pin Size | 'A' Grip Length |
|-----------|---------------|-----------------|-----------|---------------|-----------------|
| 126-980 | 3/16 x 1-9/16 | 1-1/4 | 126-984 | 5/16 x 1-9/16 | 1-1/4 |
| 126-982 | 1/4 x 1-9/16 | 1-1/4 | 126-986 | 7/16 x 1-9/16 | 1-11/32 |

For Hitch Pin Clips, Rapid Repair Washers, Cotter Pins, Clevis Pins and Clevis Yokes see index for pages on these items.

126
Series

papeo® SAFETY PINS
EPINGLE SURETE



‘Papco’ Safety Pins are made from hard drawn plated spring wire and afford positive locking action for retaining Clevis and other types of pins. Used on farm equipment, industrial applications, trucks etc. wherever safety is an issue.

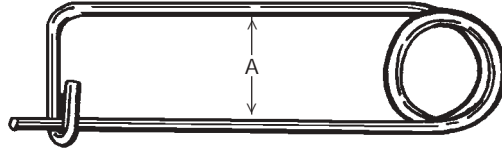

Order by Stock Number

Standard Package 10 Pins

| Stock No. | Inside Clearance 'A' | Overall Length | Usable Length | Stock No. | Inside Clearance 'A' | Overall Length | Usable Length |
|-----------|----------------------|----------------|---------------|-----------|----------------------|----------------|---------------|
| 126-932 | 3/8 | 1-3/4 | 1-1/16 | 126-936 | 13/16 | 4-3/8 | 2-13/16 |
| 126-934 | 5/8 | 2-3/4 | 1-11/16 | 126-938 | 1-1/8 | 5-3/4 | 3-3/4 |

126
Series

papeo® ROOFING/SIDING SCREWS
VIS DE TOITURE

‘SELF SEALING’

INDENTED HEX WASHER HEAD WITH WEATHERSEALING WASHER

Specially designed screws for attaching metal siding or roofing. Features a neoprene weathersealing washer under the head of screws. High-carbon, zinc plated steel. Also available with painted heads in white, bone, brown and red. Price on application.



Order by Stock Number

Standard Package 100 Screws

| Stock No. | Size | Hex Head Across Flats | Stock No. | Size | Hex Head Across Flats |
|-----------|------------|-----------------------|-----------|------------|-----------------------|
| 126-950 | 10 x 1 | 1/4 | 126-963 | 14 x 1-1/4 | 3/8 |
| 126-952 | 10 x 1-1/2 | 1/4 | 126-964 | 14 x 1-1/2 | 3/8 |
| 126-954 | 10 x 2 | 1/4 | 126-966 | 14 x 2 | 3/8 |
| 126-962 | 14 x 1 | 3/8 | | | |

papeo® ELEVATOR BOLTS
BOULONS D'ELEVATEUR

125
Series

UNC
Coarse
Thread

Bare Metal

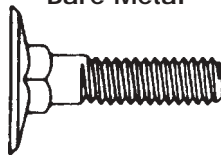

Stress
Relieved

These flat countersunk head square neck Elevator Bolts have large diameter flush heads. Used on elevator buckets and industrial belting where low head clearance is needed. Also used extensively in truck and trailer applications for walls, floors, racks and trailer doors.

Order by Stock Number

Standard Package Contains 100 Bolts

| Stock No. | Size | Stock No. | Size | Stock No. | Size |
|-----------|-----------|-----------|------------|-----------|-------------|
| 125-307 | 1/4 x 3/4 | 125-442 | 5/16 x 3/4 | | |
| 125-309 | 1 | 125-444 | 1 | | |
| 125-311 | 1-1/4 | 125-446 | 1-1/4 | 125-491 | 3/8 x 1-1/4 |
| 125-313 | 1-1/2 | 125-448 | 1-1/2 | 125-493 | 1-1/2 |
| 125-316 | 2 | 125-451 | 2 | 125-496 | 2 |
| Head Dia. | 1" | 1-3/16" | | 1-5/16" | |

Length measured overall.



255
Series

papeco CLEVIS YOKES JOUGS DE CHAPE

DROP
FORGED
U N F
FINE THREAD

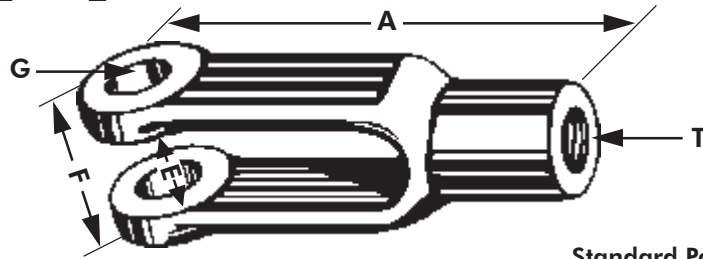

5 Sizes will
service all Cars
and Trucks.

Order by Stock Number

Standard Package 6 assemblies.

| Stock No. | Size Chart | | | | | Used with S.A.E. Standard Pins | |
|-----------|------------|-------|------|-------|-----|--------------------------------|-------------|
| | G | A | T | E | F | Clevis Pins | Cotter Pins |
| 255-026 | 1/4 | 2 | 1/4 | 9/32 | 5/8 | 255-224 | 1/16 x 1/2 |
| 255-027 | 5/16 | 2-1/4 | 5/16 | 11/33 | 3/4 | 255-226 | 3/32 x 1/2 |
| 255-028 | 3/8 | 2-1/2 | 3/8 | 7/16 | 7/8 | 255-236 | 3/32 x 3/4 |
| 255-029 | 7/16 | 2-7/8 | 7/16 | 1/2 | 1 | 255-241 | 3/32 x 1 |
| 255-030 | 1/2 | 3 | 1/2 | 9/16 | 1 | 255-245 | 1/8 x 1 |

"Papco" CLEVIS YOKES are supplied in five sizes to service all popular cars and trucks. A Yoke Assembly includes the Yoke, Clevis Pin and Cotter Pin. Standard Package consists of 6 Clevis Yoke Assemblies.

255
Series

papeco UNIVERSAL CLEVIS PINS GOUPILES JOUG UNIVERSEL



Each diameter has multiple cotter pin holes to provide wide range of grip lengths. Reduces the number of pins required for emergency coverage for cars, trucks and farm implements.

Standard Package 6 pins.

UTILITY ASSORTMENT No. 020-329

Contains 24 Universal Clevis Pins in 6 popular sizes.

Packed in a sturdy fibre-board container.

| Stock No. | Dia. x Length | Stock No. | Dia. x Length |
|-----------|---------------|-----------|---------------|
| 255-044 | 1/4 x 2 | 255-084 | 1/2 x 2 |
| 255-054 | 5/16 x 2 | 255-086 | 1/2 x 3 |
| 255-064 | 3/8 x 2 | 255-106 | 5/8 x 3 |
| 255-074 | 7/16 x 2 | 255-126 | 3/4 x 3 |
| 255-076 | 1/2 x 3 | | |



UNIVERSAL CLEVIS PINS GARAGE ASSORTMENT No. 020-061

Contains 5 each of 255-044, 054, 064 Universal Clevis Pins. Each size in an individual compartment in a rigid plastic box.



papeco UNIVERSAL CLEVIS PINS GOUPILES JOUG UNIVERSEL

Convenient skin-packed card contains one Universal Clevis Pin and one Hitch Pin Clip.

Order by Stock Number

| Card No. | Size | Hitch Pin Clip | Card No. | Size | Hitch Pin Clip |
|----------|----------|----------------|----------|---------|----------------|
| 255-044 | 1/4 x 2 | 255-303 | 255-084 | 1/2 x 2 | 255-303 |
| 255-054 | 5/16 x 2 | 255-303 | 255-086 | 1/2 x 3 | 255-303 |
| 255-064 | 3/8 x 2 | 255-307 | 255-106 | 5/8 x 3 | 255-307 |
| 255-074 | 7/16 x 2 | 255-311 | 255-126 | 3/4 x 3 | 255-311 |
| 255-076 | 7/16 x 3 | 255-311 | | | |

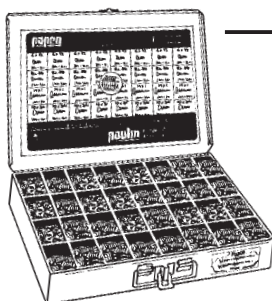
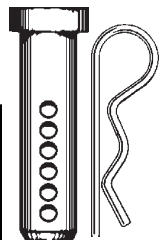

papeco SUPER SERVICE ASSORTMENT No. 020-816

Contains 173 Standard and Universal Clevis Pins and Clips — 40 items.
Large size, rigid metal box with high-strength plastic compartments.

For more details see page 9.

Large size: 12" w. x 18" l. x 3" d.

255
Series

papco CLEVIS PINS GOUPILES JOUG

Lengths shown are from under head to end of pin.



Order by Stock Number

Standard Package 25 pieces

| Stock No. | Dia. x Length | Stock No. | Dia. x Length | Stock No. | Dia. x Length | Stock No. | Dia. x Length |
|-----------|---------------|-----------|---------------|-----------|----------------|-----------|---------------|
| 255-221 | 3/16 x 5/8 | 255-228 | 5/16 x 1-1/4 | * 255-236 | 3/8 x 1-3/32 | 255-244 | 7/16 x 1-3/4 |
| * 255-224 | 1/4 x 51/64 | 255-208 | 5/16 x 1-1/2 | 255-237 | 3/8 x 1-1/4 | 255-251 | 1/2 x 1-1/4 |
| 255-225 | 1/4 x 1 | 255-230 | 5/16 x 1-9/16 | 255-238 | 3/8 x 1-3/8 | * 255-245 | 1/2 x 1-27/64 |
| 255-203 | 5/16 x 3/4 | 255-231 | 5/16 x 1-3/4 | 255-239 | 3/8 x 1-1/2 | 255-246 | 1/2 x 1-1/2 |
| * 255-226 | 5/16 x 31/32 | 255-213 | 3/8 x 7/8 | * 255-241 | 7/16 x 1-15/64 | 255-248 | 1/2 x 2 |
| 255-205 | 5/16 x 1-1/8 | 255-235 | 3/8 x 1 | 255-242 | 7/16 x 1-1/2 | | |

* Used with S.A.E. Standard Clevis Yokes.



CLEVIS PIN MASTER ASSORTMENT No. 020-641

This well-balanced assortment is packed in a sturdy, welded, metal box with moulded plastic compartments.

Each size of clevis pin is an individual compartment.

Complete specifications are shown on the grease-resistant lid label.

CLEVIS PINS GARAGE ASSORTMENT No. 020-062

Contains 41 Clevis Pins,
all popular sizes.



255
Series

papco HITCH PIN CLIPS AGRAFES POUR GOUIPILLE D'ATTELAGE

'Papco' Hitch Pin Clips are made of oil-tempered spring steel wire and are bright plated. Used on agricultural implements, lawn mowers, snowmobiles, construction and automotive equipment.

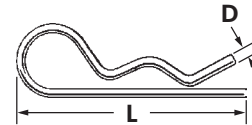

Order by Stock Number

Standard Package 25 pieces

| Stock No. | Nom. Wire Diameter | Overall Length | Fit Shaft Diameters | | I.D. of Eye |
|-----------|--------------------|----------------|---------------------|---------|-------------|
| | | | Minimum | Maximum | |
| 255-326 | 1/32 | 7/16 | 7/64 | 9/64 | 5/16 |
| 255-321 | 3/64 | 5/8 | 1/8 | 3/16 | 1/8 |
| 255-325 | 5/64 | 1-3/32 | 5/16 | 3/8 | 9/64 |
| 255-313 | 3/32 | 1-3/16 | 1/4 | 3/8 | 1/4 |
| 255-303 | 3/32 | 1-5/8 | 1/4 | 1/2 | 5/16 |
| 255-307 | 3/32 | 2-5/16 | 1/4 | 5/8 | 5/8 |
| 255-314 | 3/32 | 2-1/2 | 3/8 | 3/4 | 7/16 |
| 255-316 | 1/8 | 1-3/4 | 1/2 | 3/4 | 7/16 |
| 255-311 | 1/8 | 2-9/16 | 7/16 | 3/4 | 7/16 |
| 255-309 | 5/32 | 3-5/16 | 3/4 | 1-1/8 | 3/4 |
| 255-310 | 5/32 | 2-15/16 | 5/8 | 1" | 3/4 |
| 255-306 | 3/16 | 3-1/4 | 5/8 | 1" | 7/8 |
| 255-308 | 3/16 | 3-3/4 | 7/8 | 1-1/4 | 7/8 |
| 255-319 | 1/4 | 4-3/8 | 1" | 1-1/2 | 3/4 |
| 255-320 | 5/16 | 3-15/16 | 1" | 1-1/2 | 7/8 |

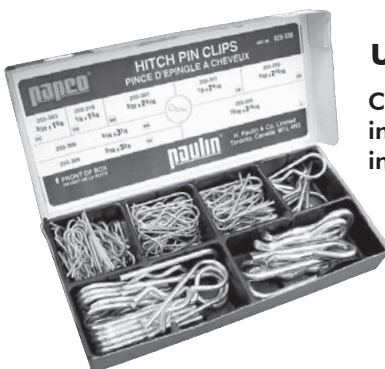

HITCH PIN CLIP UTILITY ASSORTMENT No. 020-338

Contains 105 Hitch Pin Clips, 8 sizes. Packed in a sturdy, fibre-board container with individual compartments.

HITCH PIN CLIP FARAGE ASSORTMENT No. 020-073

Contains 40 Hitch Pin Clips, 6 sizes. Packed in a clear plastic box.





165
C's
Hundreds

165
M's
Thousands

papeo COTTER PINS
GOUPILES



BRIGHT ELECTRO-PLATED WITH CHROMATE FINISH

'Papco' Steel Cotter Pins are made in the extended prong style for easy insertion and locking. The length is measured under the head to the end of the shortest leg. Packaging is in Standard Packages of 100 pieces and in Packages of 1000* where indicated. All Cotter Pins are Bright Plated.

Order by Stock Number

Packages of 100 add prefix 165.

Packages of 1,000 add prefix 166.

Example of Stock Number 165-148 is 1/8 x 2 Steel Cotter Pins Plated in packages of 100.

| Diameter | 1/32 | 3/64 | 1/16 | 5/64 | 3/32 | 7/64 | 1/8 | 5/32 | 3/16 | 1/4 | 5/16 | 3/8 |
|---------------|------|------|-------|------|-------|------|-------|-------|-------|-------|-------|------|
| Length | | | | | | | | | | | | |
| 1/2 | -019 | -030 | -043 | | -087 | | -137 | | | | | |
| 3/4 | | -032 | -045* | -065 | -089* | | -139* | | | | | |
| 1 | | | -047* | -067 | -091* | -115 | -141* | -167* | -193* | | | |
| 1-1/4 | | | -049 | | -093 | | -143 | -169 | -195 | | | |
| 1-1/2 | | | -051* | | -095* | -119 | -145* | -171* | -197* | -313* | -448* | |
| 1-3/4 | | | -053 | | -097 | | -147 | -173 | | | | |
| 2 | | | -054 | | -098 | | -148* | -174* | -200* | -316* | -451* | -496 |
| 2-1/2 | | | | | -100 | | -150 | -176 | -202 | -318* | -453* | -498 |
| 3 | | | | | | | -152 | -178 | -204 | -320* | -455* | -500 |
| 3-1/2 | | | | | | | | | | -322 | -457 | -502 |
| 4 | | | | | | | | | | -324 | -459 | -504 |

COTTER PIN ASSORTMENT – No. 020-866

This Assortment consists of approximately 100 Cotter Pins in 1/16", 3/32", and 1/8" Diameters, and from 1/2" to 1-1/4" in lengths. Standard Package contains 24 individual assortments. All Bright Plated.



GARAGE ASSORTMENT – No. 020-033

Contains 340 Cotter Pins, seven sizes from 1/16" x 3/4" to 5/32" x 2". Packed in handy, clear plastic container. All Bright Plated.



UTILITY ASSORTMENT – No. 020-313

This Assortment of 1,000 Cotter Pins, in 10 popular sizes packed in individual compartments. Container is sturdy fibreboard with a hinged lid. All Bright Plated.

UTILITY ASSORTMENT – No. 020-343

This assortment contains 195 Large Size Cotter Pins - 9 sizes from 5/32" x 2" to 3/8" x 3". Packed in a sturdy fibreboard container each size in an individual compartment. Useful for Agricultural and Construction Equipment. All Bright Plated.



MASTER ASSORTMENT – No. 020-618

Contains 1230 Plated Cotter Pins, 20 sizes from 1/16" x 1/2" x 3/16" x 2". Packed in a metal, lidded box with moulded plastic compartments. Retail codes shown on lid label.

Size: 9-3/4" w.
x 13-3/4" l.
x 2" d.

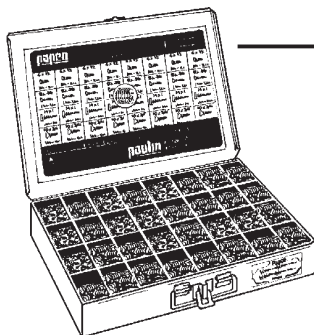

papeo SUPER SERVICE ASSORTMENT No. 020-805

Contains 3345 Plated Cotter Pins and Throttle Rod Retainers - 32 items. Large size, rigid metal box with high-strength plastic compartments.

For more details see page 9.

Large size: 12" w. x 18" l. x 3" d.

167
Series

papco 'HAMMER-LOCK' COTTER PINS
GOUPILLES 'HAMMER-LOCK'



BRIGHT ELECTRO-PLATED



These Cotter Pins spread automatically when hit with a hammer. The shorter shank rides over the up-turned point of the longer and locks rigidly. Twisting with a screwdriver returns pin to its original position. May also be used as standard cotter pins if desired.

Order by Stock Number

Standard Package 100 Pieces

| Stock No. | Size Dia. x Length | Stock No. | Size Dia. x Length | Stock No. | Size Dia. x Length |
|-----------|--------------------|-----------|--------------------|-----------|--------------------|
| 167-045 | 1/16 x 3/4 | 167-091 | 3/32 x 1 | 167-148 | 1/8 x 2 |
| 167-047 | 1/16 x 1 | 167-095 | 3/32 x 1-1/2 | 167-171 | 5/32 x 1-1/2 |
| 167-051 | 1/16 x 1-1/2 | 167-141 | 1/8 x 1 | 167-174 | 5/32 x 2 |
| 167-089 | 3/32 x 3/4 | 167-145 | 1/8 x 1-1/2 | | |

papco HAMMER-LOCK
COTTER PIN ASSORTMENT

UTILITY ASSORTMENT No. 020-314

Contains 800 Cotter Pins in the 10 popular sizes listed above. Each size is in an individual compartment in the sturdy fibreboard container. All Bright Plated.



168
Series

papco BRASS COTTER PINS
GOUPILLES LAITON

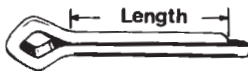

'Papco' BRASS Cotter Pins are used for marine applications, electrical and carburetor work.

Order by Stock Number

Standard Package 100 Pins

| Stock No. | Size Dia. x Length | Stock No. | Size Dia. x Length |
|-----------|--------------------|-----------|--------------------|
| 168-106 | 3/64 x 3/8 | 168-316 | 3/32 x 1 |
| 168-212 | 1/16 x 3/4 | 168-324 | 3/32 x 1-1/2 |
| 168-216 | 1/16 x 1 | 168-416 | 1/8 x 1 |
| 168-224 | 1/16 x 1-1/2 | 168-424 | 1/8 x 1-1/2 |
| 168-312 | 3/32 x 3/4 | 168-432 | 1/8 x 2 |

UTILITY ASSORTMENT No. 020-322

This assortment contains 500 Brass Cotter Pins, 50 each of 10 Stock Sizes. packed in individual compartments in sturdy metal-edge fibre board box.





141
Series

papco UNI-RODS®

FULLY THREADED STEEL RODS

Continuous
Coarse Thread



Threaded
Full Length

These continuous threaded rods are made of cold drawn steel and are Zinc Plated or Bare Metal. Can be bent to shape without heating. Very useful in machine shops, garages, and for general maintenance. Used to make eye bolts, stud bolts, anchor bolts and for suspending equipment from ceilings, mountings on walls, etc. Just cut to length and use.

Order by Stock Number Tensile strength up to 5/8": 64,000 p.s.i. (min) 3/4" up: 55,000 p.s.i.(min)

| Length | Inch Sizes | | | | | | | | Metric Sizes | | | | |
|---------|------------|---------|---------|--------|-----------|---------|---------|------|--------------|---------|---------|-------|-----------|
| | 36" | | 12" | | Std. Pkg. | 36" | | | Std. Pkg. | Length | 1 metre | 300mm | Std. Pkg. |
| | Dia. | Plated | Bare | Plated | | Dia. | Plated | Bare | | | | | |
| 1/4-20 | 141-314 | 141-354 | 141-204 | 25 | 5/8-11 | 141-324 | 141-364 | 5 | M6 | 141-706 | 141-606 | 10 | |
| 5/16-18 | 141-316 | 141-356 | 141-206 | 20 | 3/4-10 | 141-326 | 141-366 | 5 | M8 | 141-708 | 141-608 | 10 | |
| 3/8-16 | 141-318 | 141-358 | 141-208 | 15 | 7/8-9 | 141-328 | 141-368 | 3 | M10 | 141-710 | 141-610 | 10 | |
| 7/16-14 | 141-320 | 141-360 | — | 10 | 1"-8 | 141-330 | 141-370 | 3 | M12 | 141-712 | 141-612 | 5 | |
| 1/2-13 | 141-322 | 141-362 | 141-212 | 10 | | | | | | | | | |

Threaded Rods from 1/4-20 to 1-8 available in 6, 10 and 12 foot lengths.

For Stainless Steel Threaded Rods see page 164.

papcolloy B7 HIGH STRENGTH UNI-RODS®

B7 Alloy Rod

Gold Zinc Dichromate Plated

High strength continuous threaded rod to ASTM A-193 B7 Specification. Heat treated. Chrome-moly steel, tensile strength exceeds 125,000 p.s.i. Used for vehicles, construction, mining, chemical and petroleum equipment. Temperature service range from -150°F to +850°F. UNC coarse thread or UNF fine thread.

| UNC Stock | UNF Stock | Size | Std. Pkg. | UNC Stock | UNF Stock | Size | Std. Pkg. | UNC Stock | UNF Stock | Size | Std. Pkg. |
|-----------|-----------|-----------|-----------|-----------|-----------|-----------|-----------|-----------|-----------|----------|-----------|
| 141-550 | 141-570 | 1/4 x 36 | 5 | 141-553 | 141-573 | 7/16 x 36 | 2 | 141-557 | 141-577 | 3/4 x 36 | 2 |
| 141-551 | 141-571 | 5/16 x 36 | 4 | 141-554 | 141-574 | 1/2 x 36 | 2 | 141-558 | 141-578 | 7/8 x 36 | 1 |
| 141-552 | 141-572 | 3/8 x 36 | 3 | 141-556 | 141-576 | 5/8 x 36 | 2 | 141-559 | 141-579 | 1" x 36 | 1 |



papco HEX COUPLING NUTS

Plated Hexagon Steel Nuts for joining or adjusting Threaded Rods

| Stock No. | Dia. | Dimensions | Std. Pkg. | Stock No. | Dia. | Dimensions | Std. Pkg. |
|-----------|---------|--------------|-----------|---|--------|---------------|-----------|
| 141-914 | 1/4-20 | 7/16 x 7/8 | 50 | 141-924 | 5/8-11 | 15/16 x 2-1/8 | 15 |
| 141-916 | 5/16-18 | 1/2 x 1-3/4 | 25 | 141-926 | 3/4-10 | 1-1/8 x 2-1/4 | 15 |
| 141-918 | 3/8-16 | 9/16 x 1-3/4 | 25 | 141-928 | 7/8-9 | 1-1/4 x 2-1/2 | 10 |
| 141-920 | 7/16-14 | 5/8 x 1-3/4 | 25 | 141-930 | 1"-8 | 1-1/4 x 2-1/2 | 10 |
| 141-922 | 1/2-13 | 3/4 x 1-3/4 | 25 | Dimensions: width across flats x length | | | |

papco UNI-BOLT® KITS

FULLY THREADED STEEL RODS, NUTS, WASHERS

Full threaded 'UNI-BOLTS' can be cut and shaped to make any length or style of bolt. Each kit contains plated parts for two complete bolts - lock washers, flat washers and hex nuts. Available in four coarse thread inch diameters and four metric diameters 12 inches (300mm) long.

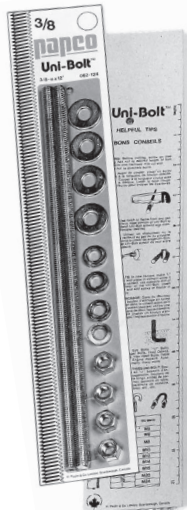

| Card No. | Size | Card No. | Size |
|----------|---------------|----------|-------------|
| 141-104 | 1/4-20 x 12" | 141-154 | M6 x 300mm |
| 141-114 | 5/16-18 x 12" | 141-164 | M8 x 300mm |
| 141-124 | 3/8-16 x 12" | 141-174 | M10 x 300mm |
| 141-134 | 1/2-13 x 12" | 141-184 | M12 x 300mm |

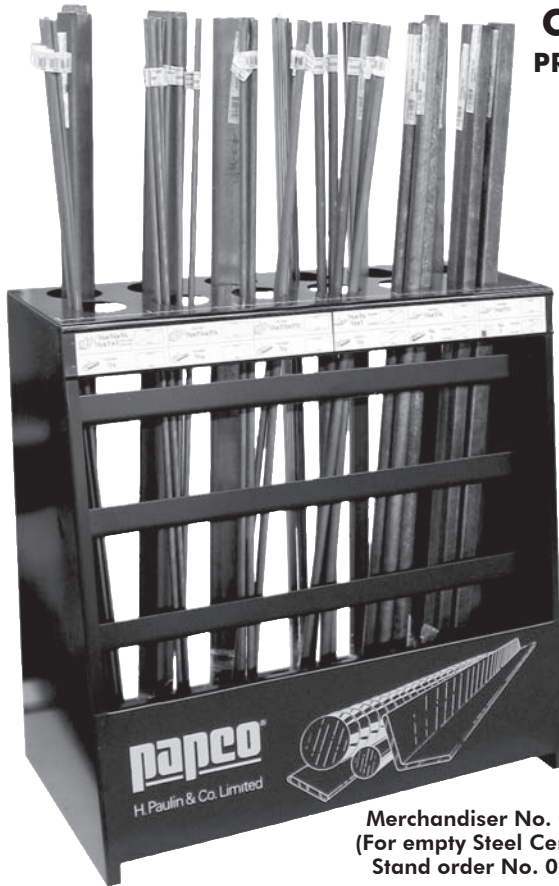

**BASIC STOCK FOR AUTOMOTIVE,
INDUSTRIAL, FARM AND HARDWARE**

This sturdy merchandiser holds 16 sizes of bare metal construction grade steel. Contains the right selection of flats, round and angles needed in daily repairs. Steel can be cut, bent, drilled and welded as required. All items handy 36" length.

- Wide range of steel for general repairs.
- Sturdy, all-metal floor stand.
- Retail price labelled.
- Can hold parts bins for fasteners, etc.
- Size 24-1/2"w. x 13-1/2"d. x 24"h.
- Shipping weight with stock 100 pounds.
- Contains 52 steel shapes - one standard package of each size.

Merchandiser No. 022-008
(For empty Steel Centre Floor
Stand order No. 022-014)

BARE METAL STEEL and ALUMINUM RODS and SHAPES

| Stock No. | Size | Std. Pkg. | Wt. Ea.* | Part No. | Size | Std. Pkg. | Wt. Ea.* | Stock No. | Size | Std. Pkg. | Wt. Ea.* | Part No. | Size | Std. Pkg. | Wt. Ea.* |
|---------------------|-----------|-----------|----------|------------------------|-----------|-----------|----------|---------------------|-----------|-----------|----------|------------------------|-----------|-----------|----------|
| 36" LONG | | | | | | | | 36" LONG | | | | | | | |
| | | | | | | | | | | | | | | | |
| STEEL ROUNDS | | | | ALUMINUM ROUNDS | | | | STEEL FLATS | | | | ALUMINUM FLATS | | | |
| 142-004 | 1/4 dia. | 5 | .5 | 142-808 | 3/8 dia. | 5 | .4 | 142-040 | 1/8x3/4 | 3 | 1.0 | 142-640 | 1/8x3/4 | 3 | 0.3 |
| 142-006 | 5/16 dia. | 5 | .8 | 142-812 | 1/2 dia. | 5 | .7 | 142-042 | 1/8x1 | 3 | 1.2 | 142-642 | 1/8x1 | 3 | 0.4 |
| 142-008 | 3/8 dia. | 5 | 1.1 | 142-814 | 5/8 dia. | 3 | 1.1 | 142-044 | 1/8x1-1/4 | 3 | 1.6 | 142-646 | 1/8x1-1/2 | 3 | 0.6 |
| 142-012 | 1/2 dia. | 5 | 2.0 | | | | | 142-046 | 1/8x1-1/2 | 3 | 2.0 | 142-648 | 1/8x2 | 3 | 0.9 |
| 36" LONG | | | | | | | | 36" LONG | | | | | | | |
| | | | | | | | | | | | | | | | |
| STEEL ANGLES | | | | ALUMINUM ANGLES | | | | STEEL TUBING | | | | ALUMINUM TUBING | | | |
| 142-100 | 1/8x3/4 | 3 | 1.8 | 142-700 | 1/8x3/4 | 3 | .6 | 142-302 | 3/4 Sq. | 2 | 1.7 | 142-430 | 3/4 Sq. | 3 | 0.5 |
| 142-102 | 1/8x1 | 3 | 2.4 | 142-702 | 1/8x1 | 3 | .8 | 142-304 | 1" Sq. | 2 | 3.9 | 142-432 | 1" Sq. | 3 | 0.6 |
| 142-104 | 1/8x1-1/4 | 3 | 3.0 | 142-706 | 1/8x1-1/2 | 3 | 1.2 | 142-402 | 3/4 Rd. | 2 | 1.3 | 142-338 | 3/4 Rd. | 3 | 0.4 |
| 142-106 | 1/8x1-1/2 | 3 | 3.7 | 142-708 | 1/8x2 | 3 | 1.6 | 142-404 | 1" Rd. | 2 | 3.1 | 142-340 | 1" Rd. | 3 | 0.5 |

Included in Steel Centre Merchandiser No. 022-008

Note: 3/4 Steel Tubing wall = .065, 1" = .100
3/4 and 1" Aluminum Tubing wall = .050

* lbs.



papeo[®] METAL CENTRE PLUS

MERCHANDISER No. 022-007

CENTRE DU MÉTAL PLUS PRÉSENTOIR No. 022-007



MASTER STOCK OF CONSTRUCTION
GRADE STEEL FOR AUTOMOTIVE,
INDUSTRIAL, FARM, HARDWARE
AND HOME

Cold rolled steel sheets, galvanized steel,
aluminum sheets and expanded metal.

Contains the right selection of flats, rounds
and angles (see Merchandiser No. 022-
008), plus sheets needed in daily repairs
(see below).

Can be cut, bent, formed, drilled and
welded as required.

- Wide range of metal for general repairs.
- Sturdy all-metal floor stand.
- Retail price labelled.
- Can hold parts bins for related fasteners.
- New graphic label channel and protector guard bar - a safe retail unit.
- Shipping weight with stock 125 pounds.
- Contains 55 Steel shapes - one package of each size PLUS 12 metal sheets.

Size: 24-1/2" w. x 13-1/2" d. x 24" h.

papeo[®] SHEET STEEL FEUILLES DE TÔLE

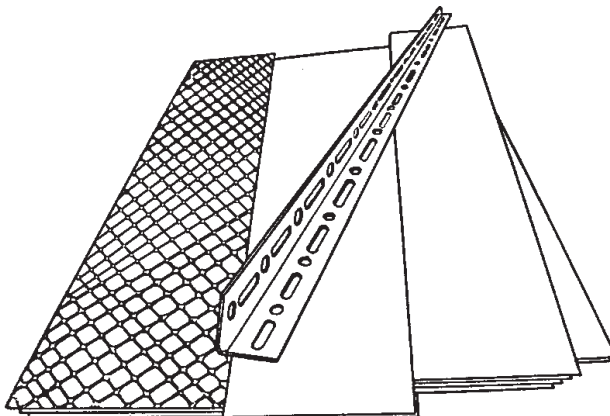

| Part No. | Size | Description | Std. Pkg. | Wt. lbs. |
|----------|--------------|-----------------------------|-----------|----------|
| 142-524 | 8" x 24" | 22ga. C.R. Steel Sheet | 2 | 1.7 |
| 142-528 | 12" x 24" | 22ga. C.R. Steel Sheet | 2 | 2.5 |
| 142-495 | 12" x 24" | 26ga. Galvanized Sheet | 2 | 1.8 |
| 142-551 | 12" x 24" | .025 Aluminum Sheet | 2 | 0.7 |
| 142-558 | 12" x 24" | 1/2" Expanded Metal | 2 | 2.9 |
| 142-568 | 12" x 24" | 3/4" Expanded Metal | 2 | 1.7 |
| 142-200* | 1-1/2" x 36" | .074 Slotted Angles | 3 | 2.1 |
| 142-202 | 1-1/2" x 48" | .074 Slotted Angles - Galv. | 3 | 4.8 |
| 142-204 | 1-1/2" x 72" | .074 Slotted Angles - Galv. | 3 | 7.8 |
| 142-220 | 1-3/8" x 36" | .074 Slotted Flats - Galv. | 3 | 2.4 |
| 142-222 | 1-3/8" x 48" | .074 Slotted Flats - Galv. | 3 | 3.6 |

WARNING: DO NOT Weld Galvanized metal as toxic fumes may be present.

C.R. = Cold Rolled

papeo® UNI-ROD® MERCHANDISERS PRESENTOIRS UNI-ROD®



Feature a heavy-duty, labelled steel floor stand to display and sell threaded rods, coupling nuts, washers, etc.



| No. 022-010 PLATED UNI-RODS, COUPLING NUTS | | | |
|--|-----------|---------------|-----------|
| Metal Merchandiser with Six Service Bins | | | |
| 36" THREADED RODS | | COUPLING NUTS | |
| 25 | 1/4" Rods | 10 | 1/2" Rods |
| 20 | 5/16" | 5 | 5/8" |
| 15 | 3/8" | 5 | 3/4" |
| 50 | 1/4 Nuts | 25 | 1/2 Nuts |
| 25 | 5/16 | 15 | 5/8 |
| 25 | 3/8 | 15 | 3/4 |

| No. 022-011 PLATED UNI-RODS | |
|-----------------------------|----------------------|
| With Metal Merchandiser | |
| 25 | 1/4 x 36 Plated Rods |
| 20 | 5/16 |
| 15 | 3/8 |
| 10 | 1/2 x 36 Plated Rods |
| 5 | 5/8 |
| 5 | 3/4 |

| No. 022-012 BARE METAL UNI-RODS | |
|---------------------------------|--------------------|
| With Metal Merchandiser | |
| 25 | 1/4 x 36 Bare Rods |
| 20 | 5/16 |
| 15 | 3/8 |
| 10 | 1/2 x 36 Bare Rods |
| 5 | 5/8 |
| 5 | 3/4 |

(For empty Threaded Rod Floor Stand order 022-014 Bins NOT included. For plastic Bins No. 022-040 see page 13.)

Merchandiser No. 022-010
Size: 24-1/2" w. x 13-1/2" d. x 24" h.

| No. 022-013 PLATED THREADED RODS, NUTS, WASHERS, COUPLING NUTS | | | |
|--|-------------------|------------------|------------------|
| Deluxe Display with Metal Merchandiser and 18 Service bins. Complete Coverage. | | | |
| Threaded Rods | Finished Nuts | S.A.E. Washers | Coupling Nuts |
| 25 1/4" 141-314 | 200 1/4" 083-014 | 200 1/4 154-014 | 50 1/4" 141-914 |
| 20 5/16" 141-316 | 200 5/16" 083-016 | 200 5/16 154-016 | 25 5/16" 141-916 |
| 15 3/8" 141-318 | 200 3/8" 083-018 | 200 3/8 154-018 | 25 3/8" 141-918 |
| 10 1/2" 141-322 | 100 1/2" 083-022 | 200 1/2 154-022 | 25 1/2" 141-922 |
| 5 5/8" 141-324 | 50 5/8" 083-024 | 100 5/8 154-024 | 15 5/8" 141-924 |
| 5 3/4" 141-326 | 50 3/4" 083-026 | 100 3/4 154-026 | 15 3/4" 141-926 |

PLATED THREADED ROD ASSORTMENT No. 020-900

Contains 10 lengths of continuous Threaded Rod, 30 feet altogether.

Two lengths each of 1/4", 5/16", 3/8", 7/16", and 1/2" diameter.

With this handy assortment you can make up those extra long bolts quickly and easily.

Save time—no thread cutting required. Save money—no delays and no need to carry large bolt stocks.

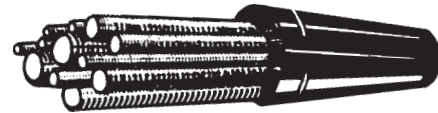

12 INCH UNI-ROD DISPLAY No. 020-903

This assortment contains 50 lengths: 10 each of 1/4, 5/16, 1/2 and 20 lengths of 3/8 x 12" fully threaded steel rods. All bright plated to resist rust. Attractive all-metal merchandiser can stand on counter or hang on wall.



Metal Display Size: 11" w. x 3" d. x 11" h.

METRIC UNI-ROD DISPLAY No. 020-904

This assortment contains 50 lengths: 10 each of M5, M10, M12 and 20 lengths of M8 x 300mm fully threaded steel rods blue plated. All-metal merchandiser can stand on counter or hang on wall.



papeco® PLAIN STEEL WASHERS RONDELLES ORDINAIRES



(U.S.S. Wrought Washers)

papeco FLAT WASHERS are free from burrs and have smooth, flat surfaces.



143
1 lb. Bare

144
5 lbs. Bare

145
100's Bare

146
1 lb. Plated

148
100's Plated

Order by Stock Number

Standard Packages as indicated

| Stock No.'s | | | | | 100's Std. Pkg. | Bolt Size | Hole Size | Outside Dia. | Thickness | Approx. No. per lb. |
|--------------------|----------------------|------------|---------------------|--------------|-----------------|-----------|-----------|--------------|-----------|---------------------|
| 1 lb. Bare (454 g) | 5 lbs. Bare (2.2 kg) | 100's Bare | 1 lb Plated (454 g) | 100's Plated | | | | | | |
| 143-010 | 144-010 | 145-010 | 146-010 | 148-010 | 100 | 3/16 | 1/4 | 9/16 | 3/64 | 294 |
| 143-014 | 144-014 | 145-014 | 146-014 | 148-014 | 100 | 1/4 | 5/16 | 3/4 | 1/16 | 162 |
| 143-016 | 144-016 | 145-016 | 146-016 | 148-016 | 100 | 5/16 | 3/8 | 7/8 | 1/16 | 96 |
| 143-018 | 144-018 | 145-018 | 146-018 | 148-018 | 100 | 3/8 | 7/16 | 1 | 5/64 | 75 |
| 143-020 | 144-020 | 145-020 | 146-020 | 148-020 | 50 | 7/16 | 1/2 | 1-1/4 | 3/32 | 38 |
| 143-022 | 144-022 | 145-022 | 146-022 | 148-022 | 50 | 1/2 | 9/16 | 1-3/8 | 7/64 | 27 |
| 143-023 | 144-023 | 145-023 | 146-023 | 148-023 | 25 | 9/16 | 5/8 | 1-1/2 | 7/64 | 23 |
| 143-024 | 144-024 | 145-024 | 146-024 | 148-024 | 25 | 5/8 | 11/16 | 1-3/4 | 9/64 | 13 |
| 143-026 | 144-026 | 145-026 | 146-026 | 148-026 | 20 | 3/4 | 13/16 | 2 | 9/64 | 9 |
| 143-028 | 144-028 | 145-028 | 146-028 | 148-028 | 20 | 7/8 | 15/16 | 2-1/4 | 5/32 | 7 |
| 143-030 | 144-030 | 145-030 | 146-030 | 148-030 | 20 | 1 | 1-1/16 | 2-1/2 | 5/32 | 6 |
| | 144-032 | | | | | 1-1/8 | 1-3/16 | 2-3/4 | 5/32 | 5 |
| | 144-034 | | | | | 1-1/4 | 1-5/16 | 2-3/4 | 5/32 | 5 |
| | 144-037 | | | | | 1-1/2 | 1-9/16 | 3-1/4 | 11/64 | 3 |



PLAIN STEEL WASHER UTILITY ASSORTMENT

No. 020-352

Contains 5.5 lbs of Plain Steel Washers in bolt sizes from 3/16" to 5/8". Each size in an individual compartment. Packed in a sturdy fibre-board container. All Bright Plated.

PLAIN STEEL WASHER MASTER ASSORTMENT No. 020-620

Contains over 1615 Plain Steel Washers 10 sizes from 1/8" to 3/4". packed in a metal divided box with hinged lid, carrying handle, positive lock and illustrated label showing retail price codes. All Bright Plated.



For 'Super-Service' Assortment No. 020-804 of Plain Steel, S.A.E. and Lock Washers see page 56.

papeo® S.A.E. WASHERS RONDELLES S.A.E.



papeo S.A.E. Steel Washers are made from Strip Steel; have bright, smooth, flat surfaces; are highly polished and are free from burrs.

149
1 lb.
Bare

151
100's
Bare

154
100's
Plated

Order by Stock Number

**BRIGHT
PLATED**

Standard Packages as indicated

| Stock No.'s | | | 100's Std. Pkg. | Bolt Size | Inside Dia. | Outside Dia. | Thickness | Approx. No. per lb. |
|-----------------------|----------------|-----------------|-----------------------|--------------|----------------|-----------------|-----------|---------------------------|
| 1 lb. Bare (454 g) | 100's Bare | 100's Plated | | | | | | |
| | | 154-002 | 100 | #2 | 3/32 | 1/4 | 1/32 | 2500 |
| | | 154-004 | 100 | #4 | 1/8 | 5/16 | 1/32 | 1650 |
| | | 154-006 | 100 | #6 (1/8) | 5/32 | 3/8 | 3/64 | 800 |
| 149-008 | | 154-008 | 100 | #8 | 3/16 | 7/16 | 3/64 | 550 |
| 149-010 | 151-010 | 154-010 | 100 | #10 (3/16) | 7/32 | 1/2 | 1/16 | 350 |
| 149-014 | 151-014 | 154-014 | 100 | 1/4 | 9/32 | 5/8 | 1/16 | 225 |
| 149-016 | 151-016 | 154-016 | 100 | 5/16 | 11/32 | 11/16 | 1/16 | 200 |
| 149-018 | 151-018 | 154-018 | 100 | 3/8 | 13/32 | 13/16 | 1/16 | 140 |
| 149-020 | 151-020 | 154-020 | 50 | 7/16 | 15/32 | 59/64 | 1/16 | 105 |
| 149-022 | 151-022 | 154-022 | 50 | 1/2 | 17/32 | 1-1/16 | 3/32 | 55 |
| 149-023 | 151-023 | 154-023 | 25 | 9/16 | 19/32 | 1-3/16 | 3/32 | 45 |
| 149-024 | 151-024 | 154-024 | 25 | 5/8 | 21/32 | 1-5/16 | 3/32 | 36 |
| 149-026 | 151-026 | 154-026 | 20 | 3/4 | 13/16 | 1-1/2 | 1/8 | 22 |
| 149-028 | 151-028 | 154-028 | 20 | 7/8 | 15/16 | 1-3/4 | 1/8 | 16 |
| 149-030 | 151-030 | 154-030 | 20 | 1 | 1-1/16 | 2 | 1/8 | 12 |



SMALL SIZE S.A.E. WASHER GARAGE ASSORTMENT No. 020-031

Contains 400 pieces, 6 sizes no. 2 to 1/4" dia. For Electrical, Radio and Electronic use. Packed in a transparent plastic box.



PLATED S.A.E. WASHER UTILITY ASSORTMENT No. 020-341

Contains 370 S.A.E. Standard Steel Washers in sizes from 3/16" to 5/8". Each size is in an individual compartment in a sturdy fibreboard container.



PLATED S.A.E. WASHER MASTER ASSORTMENT No. 020-619

Contains 1200 S.A.E. Washers, 12 sizes from 1/8" to 1". Packed in a metal, divided box with hinged lid, carrying handle, positive lock and illustrated lid label showing retail price codes.

Size: 9-3/4" w. x 13-3/4" l. x 2" d.

For 'Super-Service' Assortment No. 020-804 of Plain Steel, S.A.E. and Lock Washers see page 56.



Papco® SPRING LOCK WASHERS RONDELLES RESORT

High Carbon Spring Steel - Plain Type - Non-Linking

REGULAR LOCK WASHERS



155
100's
Bare

156
1000's
Bare

157
100's
Plated

'Papco' Lock Washers provide a locking spring action against the tendency of threaded assemblies loosening due to vibration. They are made to specifications of the Society of Automotive Engineers (S.A.E.) and the current ANSI B27.1 standard. They are supplied in Regular, for Grade 2 bolts and low load applications; Papcolloy (Extra Duty) for Grade 5, 8 or 9 bolts and high load applications; and Hi-Collar for Socket Head Cap Screws.

Standard Packages: 100's - up to 1" - 100; 1-1/8 - 1-1/4 - 50; 1-1/2 - 25.

Order by Stock Number

1000's - up to - 7/16 - 1000; 1/2 to 5/8 - 500; 3/4 - 250.

| Stock No. | | | Bolt Size | Steel Section W x T | Stock No. | | | Bolt Size | Steel Section W x T |
|------------|-------------|--------------|------------|---------------------|------------|-------------|--------------|-----------|---------------------|
| 100's Bare | 1000's Bare | 100's Plated | | | 100's Bare | 1000's Bare | 100's Plated | | |
| 155-006 | 156-006 | | #6 (1/8) | .047 x .031 | 155-023 | 156-023 | 157-023 | 9/16 | .188 x .141 |
| 155-008 | 156-008 | | #8 (5/32) | .055 x .040 | 155-024 | 156-024 | 157-024 | 5/8 | .203 x .156 |
| 155-010 | 156-010 | 157-010 | #10 (3/16) | .062 x .047 | 155-026 | 156-026 | 157-026 | 3/4 | .234 x .188 |
| 155-012 | 156-012 | 157-012 | #12 (7/32) | .070 x .056 | 155-028 | | 157-028 | 7/8 | .266 x .219 |
| 155-014 | 156-014 | 157-014 | 1/4 | .109 x .062 | 155-030 | | 157-030 | 1" | .297 x .250 |
| 155-016 | 156-016 | 157-016 | 5/16 | .125 x .078 | 155-032 | | | 1-1/8 | .328 x .281 |
| 155-018 | 156-018 | 157-018 | 3/8 | .141 x .094 | 155-034 | | | 1-1/4 | .359 x .312 |
| 155-020 | 156-020 | 157-020 | 7/16 | .156 x .109 | 155-036 | | | 1-3/8 | .391 x .344 |
| 155-022 | 156-022 | 157-022 | 1/2 | .171 x .125 | 155-038 | | | 1-1/2 | .422 x .375 |

101
Series

PAPCOLLOY LOCK WASHERS

Extra Duty

4037 HIGH ALLOY STEEL

For use with Grade 5, 8 or 9 bolts and for high load applications.
Mechanical Gold Zinc Dichromate Plated.

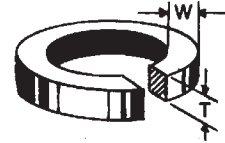

Order by Stock Number

| Stock No. | Bolt Size | Std. Pkg. | Steel Section W x T | Stock No. | Bolt Size | Std. Pkg. | Steel Section W x T |
|-----------|-----------|-----------|---------------------|-----------|-----------|-----------|---------------------|
| 101-014 | 1/4 | 100 | .109 x .062 | 101-026 | 3/4 | 40 | .234 x .188 |
| 101-016 | 5/16 | 100 | .125 x .078 | 101-028 | 7/8 | 40 | .266 x .219 |
| 101-018 | 3/8 | 100 | .141 x .094 | 101-030 | 1" | 40 | .297 x .250 |
| 101-020 | 7/16 | 100 | .156 x .109 | 101-032 | 1-1/8 | 20 | .411 x .375 |
| 101-022 | 1/2 | 50 | .171 x .125 | 101-034 | 1-1/4 | 20 | .452 x .417 |
| 101-023 | 9/16 | 50 | .188 x .141 | 101-038 | 1-1/2 | 20 | .526 x .496 |
| 101-024 | 5/8 | 50 | .203 x .156 | | | | |

159
Series

HI-COLLAR LOCK WASHERS

HIGH CARBON SPRING STEEL

For use with Socket Head Cap Screws.

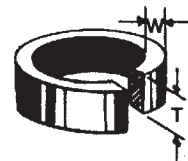

Order by Stock Number

| Stock No. | Bolt Size | Std. Pkg. | Steel Section W x T | Stock No. | Bolt Size | Std. Pkg. | Steel Section W x T |
|-----------|-----------|-----------|---------------------|-----------|-----------|-----------|---------------------|
| 159-014 | 1/4 | 100 | .047 x .078 | 159-020 | 7/16 | 100 | .090 x .140 |
| 159-016 | 5/16 | 100 | .062 x .093 | 159-022 | 1/2 | 50 | .103 x .172 |
| 159-018 | 3/8 | 100 | .076 x .125 | 159-024 | 5/8 | 50 | .125 x .203 |

papeo® SPRING LOCK WASHER ASSORTMENTS ASSORTIMENTS DE RONDELLES RESSORT



LOCK WASHER GARAGE ASSORTMENT No. 020-047

Contains 235 Regular Lock Washers Plated in sizes 3/16" to 1/2". Packed in a transparent plastic box.

LOCK WASHER ASSORTMENT No. 020-886

This popular Assortment contains 39 Lock Washers in sizes 3/16" to 1/2". Standard package contains 24 individual assortments. All Bright Plated.



LOCK WASHER UTILITY ASSORTMENT No. 020-339

This Assortment contains 505 Regular Lock Washers Plated in nine sizes from 3/16" to 3/4". Packed in a sturdy, fibreboard container with moulded compartments.

LOCK WASHER MASTER ASSORTMENT No. 020-621

Contains 1257 Regular Lock Washers Plated in twelve sizes from 1/8" to 1". Packed in a metal box with moulded plastic compartments. Hinged lid, positive lock carrying handle and illustrated lid label that shows retail price codes.



Size: 9-3/4" w. x 13-3/4" l. x 2" d.

papeo® SUPER SERVICE ASSORTMENT No. 020-804



PLAIN STEEL, S.A.E. and LOCK WASHER SUPER-SERVICE ASSORTMENT No. 020-804

Contains 3020 Flat, Lock and Tooth Lock Washers in thirty two sizes. Large size metal box with high strength moulded plastic compartments. For more details see page 9. All Bright Plated.

Size: 12" w. x 18" l. x 3" d.



161
Series

papeo

**TOOTH LOCK WASHERS
RONDELLES ANTI-VIBRATION**

Bright Zinc Plated
High Carbon Spring Steel



EXTERNAL TYPE



COUNTERSUNK TYPE



INTERNAL TYPE

Order by Stock Number

Standard Packages 100 Pieces.

| EXTERNAL TYPE | | | | COUNTERSUNK TYPE | | | | INTERNAL TYPE | | | |
|---------------|--------------------|------------------|------------|-----------------------------|--------------------|------------------|------------|---------------|--------------------|------------------|------------|
| Stock No. | Bolt or Screw Size | Outside Diameter | Thick-ness | Stock No. | Bolt or Screw Size | Outside Diameter | Thick-ness | Stock No. | Bolt or Screw Size | Outside Diameter | Thick-ness |
| 161-106 | 6 (1/8) | 5/16 | .018 | 161-306 | 6 (1/8) | 19/64 | .018 | 161-206 | 6 (1/8) | 9/32 | .018 |
| 161-108 | 8 (5/32) | 3/8 | .020 | 161-308 | 8 (5/32) | 11/32 | .018 | 161-208 | 8 (5/32) | 21/64 | .020 |
| 161-110 | 10 (3/16) | 13/32 | .022 | 161-310 | 10 (3/16) | 3/8 | .022 | 161-210 | 10 (3/16) | 3/8 | .022 |
| 161-114 | 1/4 | 1/2 | .025 | 161-314 | 1/4 | 15/32 | .022 | 161-214 | 1/4 | 15/32 | .025 |
| 161-118 | 5/16 | 19/32 | .030 | 161-318 | 5/16 | 5/8 | .025 | 161-218 | 5/16 | 19/32 | .030 |
| 161-120 | 3/8 | 11/16 | .035 | 161-320 | 3/8 | 25/32 | .030 | 161-220 | 3/8 | 11/16 | .035 |
| 161-122 | 7/16 | 25/32 | .035 | | | | | 161-222 | 7/16 | 25/32 | .035 |
| 161-124 | 1/2 | 7/8 | .040 | | | | | 161-224 | 1/2 | 7/8 | .040 |
| 161-126 | 9/16 | 31/32 | .040 | | | | | 161-226 | 9/16 | 31/32 | .040 |
| 161-128 | 5/8 | 1-1/16 | .045 | | | | | 161-228 | 5/8 | 1-1/16 | .045 |
| 161-132 | 3/4 | 1-1/4 | .050 | | | | | 161-232 | 3/4 | 1-1/4 | .050 |
| 161-134 | 7/8 | 1-7/16 | .055 | | | | | 161-234 | 7/8 | 1-3/8 | .055 |
| 161-136 | 1" | 1-5/8 | .062 | | | | | 161-236 | 1" | 1-5/8 | .062 |
| | | | | EXTERNAL COUNTERSUNK | | | | | | | |

PLATED TOOTH LOCK WASHER

**GARAGE ASSORTMENT No. 020-034
INTERNAL TYPE**

Contains 225 Internal Type
Tooth Lock Washers
in six sizes from 3/16" x 1/2"



PLATED TOOTH LOCK WASHER

**GARAGE ASSORTMENT No. 020-035
EXTERNAL TYPE**

Contains 225 External Type
Tooth Lock Washers
in six sizes from 3/16" x 1/2"



**PLATED TOOTH LOCK WASHER
UTILITY ASSORTMENT No. 020-340**

Contains 900 Internal and External Tooth Lock Washers 16 sizes from #6 to 1/2" in both types.

Packed in a sturdy fibreboard container.



**PLATED TOOTH LOCK WASHER
MASTER ASSORTMENT No. 020-625**

Contains 1370 Internal and External Washers.
10 external sizes from #6 to 3/4"; 10 internal sizes
from #6 to 3/4". Packed in a metal container with
hinged lid, carrying handle and lock.

162
Series

papco FIBRE WASHERS
RONDELLES FIBRE

1/32" – Two Thicknesses – 1/16"

"Papco" FIBRE WASHERS are made from vulcanized fibre. They are suitable for generator, carburetor or fuel pump work and wherever an insulating washer or gasket is required.

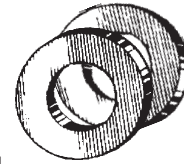

Order by Stock Number

Standard Packages 100 Pieces.

| Stock Nos. | | Inside Dia. | Out-side Dia. | Stock Nos. | | Inside Dia. | Out-side Dia. | Stock Nos. | | Inside Dia. | Out-side Dia. | Stock Nos. | | Inside Dia. | Out-side Dia. |
|------------|------------|-------------|---------------|------------|------------|-------------|---------------|------------|------------|-------------|---------------|------------|------------|-------------|---------------|
| 1/32 Thick | 1/16 Thick | | | 1/32 Thick | 1/16 Thick | | | 1/32 Thick | 1/16 Thick | | | 1/32 Thick | 1/16 Thick | | |
| 162-201 | 162-251 | 3/32 | 3/16 | 162-207 | 162-257 | 1/4 | 3/8 | 162-213 | 162-263 | 1/2 | 5/8 | 162-220 | 162-270 | 11/16 | 15/16 |
| 162-202 | 162-252 | 3/32 | 1/4 | 162-208 | 162-258 | 5/16 | 7/16 | 162-214 | 162-264 | 7/16 | 11/16 | 162-221 | 162-271 | 3/4 | 1" |
| 162-203 | 162-253 | 1/8 | 1/4 | 162-209 | 162-259 | 1/4 | 1/2 | 162-215 | 162-265 | 1/2 | 3/4 | 162-223 | 162-273 | 3/4 | 1-1/16 |
| 162-204 | 162-254 | 1/8 | 5/16 | 162-210 | 162-260 | 3/8 | 1/2 | 162-216 | 162-266 | 5/8 | 3/4 | 162-224 | 162-274 | 13/16 | 1-1/8 |
| 162-205 | 162-255 | 3/16 | 5/16 | 162-211 | 162-261 | 5/16 | 9/16 | 162-218 | 162-268 | 9/16 | 13/16 | 162-225 | 162-275 | 15/16 | 1-1/4 |
| 162-206 | 162-256 | 3/16 | 3/8 | 162-212 | 162-262 | 3/8 | 5/8 | 162-219 | 162-269 | 5/8 | 7/8 | 162-226 | 162-276 | 7/8 | 1-3/16 |
| | | | | | | | | | | | | 162-227 | 162-277 | 1 | 1-5/16 |

For Fibre Drain Plug Gaskets see page 129.

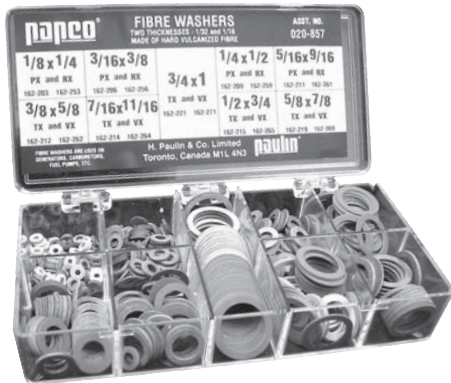

FIBRE WASHER ASSORTMENT No. 020-857

- Contains 360 Fibre Washers.
- 18 Sizes 1/16 and 1/32 thick
162-203, 206, 209, 211, 212, 214, 215, 219, 221
162-253, 256, 259, 261, 262, 264, 265, 269, 271.
- Plastic container with moulded compartments.
- Illustrated label shows sizes etc.
- Refills available in standard packages.

FIBRE WASHER GARAGE ASSORTMENT No. 020-059

This Assortment contains 130 Fibre Washers in sizes from 1/8" to 3/4".

Packed in clear, plastic box with hinged lid.



162
Series

papco FLAT FENDER WASHERS
RONDELLES AILE

BRIGHT PLATED

Used for Fender and Body work. Also two washers can be bolted together and used for Heater Hose Hole plugs.

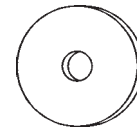

Order by Stock Number

Standard Packages 100 Pieces.

| Stock No. | Bolt Size | Outside Dia. | Inside Dia. | Thickness | Stock No. | Bolt Size | Outside Dia. | Inside Dia. | Thickness |
|-----------|-----------|--------------|-------------|-----------|-----------|-----------|--------------|-------------|-----------|
| 162-393 | 3/16 | 1" | 13/64 | 3/64 | 162-397 | 5/16 | 1-1/4 | 11/32 | 1/16 |
| 162-394 | 3/16 | 3/4 | 13/64 | 3/64 | 162-398 | 3/8 | 1-1/2 | 13/32 | 1/16 |
| 162-395 | 1/4 | 1-1/4 | 9/32 | 1/16 | 162-399 | 5/16 | 1-1/2 | 11/32 | 1/16 |
| 162-396 | 5/16 | 1" | 11/32 | 1/16 | 162-400 | 1/2 | 2" | 17/32 | 1/16 |



FENDER WASHER GARAGE ASSORTMENT No. 020-057

Contains 71 Bright Plated Fender Washers for 3/16", 1/4", 5/16" and 3/8" Bolts.

Packed in rigid, transparent plastic container.



162
Series

papeco MACHINERY BUSHINGS
BAGUES DE MACHINERIE

These steel repair bushings are used on Agricultural Machinery, Road Machines, Mine and Mill Equipment, Automobiles, Trucks, etc.

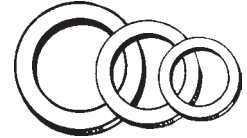

Order by Stock Number

Standard Package 25 pieces

| Stock No. | Shaft Dia. | Outside Dia. | Gauge | Weight per 100 pcs. | Stock No. | Shaft Dia. | Outside Dia. | Gauge | Weight per 100 pcs. |
|-----------|------------|--------------|-------|---------------------|-----------|------------|--------------|-------|---------------------|
| 162-610 | 5/8 | 1-1/8 | 18 | 0.9 | 162-626 | 1-1/4 | 1-7/8 | 14 | 3.4 |
| 162-611 | | | 14 | 1.5 | 162-627 | | | 10 | 6.1 |
| 162-613 | 3/4 | 1-1/4 | 18 | 1.0 | 162-631 | 1-3/8 | 2-1/8 | 18 | 2.7 |
| 162-614 | | | 14 | 1.7 | 163-632 | | | 14 | 4.6 |
| 162-615 | | | 10 | 3.1 | 162-633 | | | 10 | 8.2 |
| 162-616 | 7/8 | 1-3/8 | 18 | 1.2 | 162-635 | 1-1/2 | 2-1/4 | 14 | 4.8 |
| 162-617 | | | 14 | 2.0 | 162-636 | | | 10 | 8.6 |
| 162-619 | 1" | 1-1/2 | 18 | 1.3 | 162-640 | 1-3/4 | 2-1/2 | 18 | 3.3 |
| 162-620 | | | 14 | 2.2 | 162-641 | | | 14 | 5.6 |
| 162-621 | | | 10 | 4.0 | 162-642 | | | 10 | 10.0 |
| 162-622 | 1-1/8 | 1-3/4 | 18 | 1.9 | 162-650 | 1-7/8 | 2-7/8 | 14 | 8.3 |
| 162-623 | | | 14 | 3.1 | 162-653 | 2 | 3 | 14 | 8.6 |
| 162-624 | | | 10 | 5.6 | 162-654 | | | 10 | 15.0 |
| 162-625 | 1-1/4 | 1-7/8 | 18 | 2.0 | 162-657 | 2-1/8 | 3-1/8 | 10 | 16.3 |

18Ga.=.050"; 14Ga.=.083"; 10Ga.=.134"

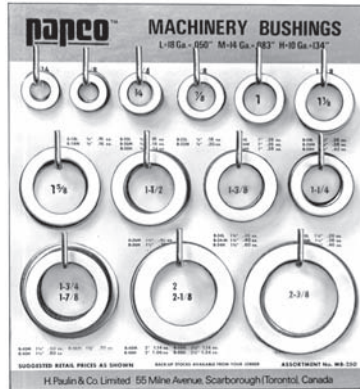

**MACHINERY BUSHING
ASSORTMENT No. 020-875**

This assortment is made up of 174 Machinery Bushings selected by popularity. Twenty eight sizes for complete coverage. The 020-875 Assortment includes a 3-colour display board and 13 screw hooks. Ideal for Implement and Machinery dealers.

162
Series

papeco RAPID REPAIR WASHERS
RONDELLES REPARATION RAPIDE

(STEEL OVERLATCH WASHERS)

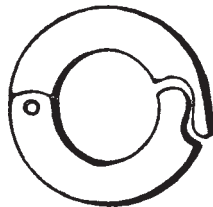

OPEN

These split bushings are applied by slipping the open washer over the shaft and tapping the overlatch in place. Save valuable time and expense by removing excess end play in shafts without dismantling the equipment. Use on farm machinery - harvesters, combines, binders - road machinery and construction equipment.

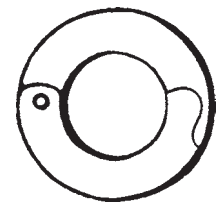

CLOSE

Order by Stock Number

Standard Package Contains 10 Washers.

| Stock No. | Shaft Dia. | Outside Dia. | Gauge | Weight per 100 pcs. | Stock No. | Shaft Dia. | Outside Dia. | Gauge | Weight per 100 pcs. |
|-----------|------------|--------------|-------|---------------------|-----------|------------|--------------|-------|---------------------|
| 162-712 | 3/4 | 1-3/4 | 1/8 | 7 | 162-722 | 1-3/8 | 2-3/8 | 1/8 | 10.5 |
| 162-714 | 7/8 | 1-7/8 | 1/8 | 8 | 162-724 | 1-1/2 | 2-1/2 | 1/8 | 11 |
| 162-716 | 1 | 2 | 1/8 | 8.5 | 162-728 | 1-3/4 | 2-3/4 | 1/8 | 12.5 |
| 162-718 | 1-1/8 | 2-1/8 | 1/8 | 9 | 162-732 | 2 | 3 | 1/8 | 14 |
| 162-720 | 1-1/4 | 2-1/4 | 1/8 | 10 | | | | | |

162
Series

papco® **RAPID REPAIR WASHERS**
RONDELLES REPARATION RAPIDE



Convenient skin-packed card includes two (2) Rapid Repair Washers. Order by Card Number



| Card No. | Shaft Dia. | Card No. | Shaft Dia. |
|----------|------------|----------|------------|
| 162-762 | 3/4 | 162-772 | 1-3/8 |
| 162-764 | 7/8 | 162-774 | 1-1/2 |
| 162-766 | 1" | 162-778 | 1-3/4 |
| 162-768 | 1-1/8 | 162-782 | 2" |
| 162-770 | 1-1/4 | | |

RAPID REPAIR WASHER ASSORTMENT No. 020-876

Includes 9 sizes of carded Rapid Repair Washers in sizes 3/4" to 2" — 30 cards in all, plus peg-board hooks and attractive three-colour point of purchase signs.



Card No.
162-766

162
Series

papco® **BRASS WASHERS**
RONDELLES LAITON

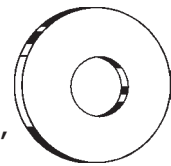

"PAPCO" BRASS WASHERS are free from burrs and have bright, smooth, flat surfaces.

Small or large patterns available from No. 6 to 3/8".

Order by Stock Number

| Stock No. | Screw or Bolt Size | I.D. | O.D. | Thick. | Std. Pkg. | Stock No. | Screw or Bolt Size | I.D. | O.D. | Thick. | Std. Pkg. |
|-----------|--------------------|------|------|--------|-----------|-----------|--------------------|--------|-------|--------|-----------|
| 162-802 | #2 | .092 | 7/32 | .018 | 100 | 162-815 | 1/4 | .260 | 11/16 | .051 | 100 |
| 162-803 | #3 | .105 | 1/4 | .020 | 100 | 162-816 | 5/16 | .337 | 3/4 | .064 | 100 |
| 162-804 | #4 | .119 | 9/32 | .025 | 100 | 162-817 | 5/16 | .337 | 7/8 | .064 | 100 |
| 162-805 | #5 | .133 | 9/32 | .025 | 100 | 162-818 | 3/8 | .391 | 7/8 | .064 | 100 |
| 162-806 | #6 | .147 | 5/16 | .028 | 100 | 162-819 | 3/8 | .391 | 1 | .081 | 100 |
| 162-807 | #6 | .147 | 3/8 | .032 | 100 | 162-820 | 7/16 | 1/2 | 1-1/8 | .081 | 50 |
| 162-808 | #8 | .172 | 3/8 | .032 | 100 | 162-822 | 1/2 | 9/16 | 1-1/4 | .091 | 50 |
| 162-809 | #8 | .172 | 7/16 | .036 | 100 | 162-823 | 9/16 | 5/8 | 1-1/2 | .091 | 25 |
| 162-810 | #10 | .200 | 7/16 | .036 | 100 | 162-824 | 5/8 | 11/16 | 1-1/2 | .102 | 25 |
| 162-811 | #10 | .200 | 1/2 | .040 | 100 | 162-826 | 3/4 | 13/16 | 1-7/8 | .114 | 20 |
| 162-812 | #12 | .227 | 1/2 | .040 | 100 | 162-828 | 7/8 | 15/16 | 2-1/4 | .128 | 20 |
| 162-813 | #12 | .227 | 9/16 | .040 | 100 | 162-830 | 1 | 1-1/16 | 2-1/2 | .144 | 20 |
| 162-814 | 1/4 | .260 | 9/16 | .040 | 100 | | | | | | |

BRASS WASHER GARAGE ASSORTMENT No. 020-056

Contains 100 Brass Washers in popular sizes from No. 10 to 1/2". Packed in a clear plastic box with hinged lid.



COPPER WASHER GARAGE ASSORTMENT No. 020-083

Contains 100 Copper Washers in six sizes from No. 10 to 1/2". Packed in a transparent plastic box with hinged lid.

162
Series

papco® **COPPER WASHERS**
RONDELLES CUIVRE



"PAPCO" soft Copper Washers are used as gaskets and have bright, smooth, flat surfaces.

Order by Stock Number

| Stock No. | Bolt Size | I.D. | O.D. | Thick. | Std. Pkg. | Stock No. | Bolt Size | I.D. | O.D. | Thick. | Std. Pkg. |
|-----------|-----------|-------|-------|--------|-----------|-----------|-----------|-------|--------|--------|-----------|
| 162-860 | #10 | 7/32 | 1/2 | 1/16 | 100 | 162-868 | 3/8 | 13/32 | 13/16 | 1/16 | 100 |
| 162-864 | 1/4 | 9/32 | 5/8 | 1/16 | 100 | 162-870 | 7/16 | 15/32 | 59/64 | 1/16 | 50 |
| 162-866 | 5/16 | 11/32 | 11/16 | 1/16 | 100 | 162-872 | 1/2 | 17/32 | 1-1/16 | 3/32 | 50 |

For Copper Drain Plug Gaskets see page 129.



162
Series

papco RAPID REPAIR WASHERS RONDELLES REPARATION RAPIDE



'Papco' Steel Spacer Washers are made from Cold Rolled Steel. All Spacer Washers are 1/32" thick.

Order by Stock Number

| Stock No. | Hole Size | O.D. | Std. Pckg. | Stock No. | Hole Size | O.D. | Std. Pckg. | Stock No. | Hole Size | O.D. | Std. Pckg. |
|-----------|-----------|-------|------------|-----------|-----------|--------|------------|-----------|-----------|-------|------------|
| 162-910 | 3/16 | 1/2 | 100 | 162-925 | 11/16 | 1-1/16 | 100 | 162-936 | 1-3/8 | 2" | 50 |
| 162-914 | 1/4 | 9/16 | 100 | 162-926 | 3/4 | 1-1/8 | 100 | 162-938 | 1-1/2 | 2-1/4 | 50 |
| 162-916 | 5/16 | 5/8 | 100 | 162-927 | 13/16 | 1-1/4 | 100 | 162-940 | 1-5/8 | 2-3/8 | 25 |
| 162-918 | 3/8 | 3/4 | 100 | 162-928 | 7/8 | 1-3/8 | 100 | 162-942 | 1-3/4 | 2-1/2 | 25 |
| 162-920 | 7/16 | 13/16 | 100 | 162-930 | 1" | 1-1/2 | 50 | 162-944 | 2 | 2-3/4 | 25 |
| 162-922 | 1/2 | 7/8 | 100 | 162-932 | 1-1/8 | 1-5/8 | 50 | 162-946 | 2-1/8 | 3" | 25 |
| 162-923 | 9/16 | 1" | 100 | 162-934 | 1-1/4 | 1-7/8 | 50 | 162-948 | 2-1/4 | 3-1/4 | 25 |
| 162-924 | 5/8 | 1" | 100 | | | | | | | | |

SPACER WASHER

GARAGE ASSORTMENT No. 020-058

Contains 125 Steel Spacer Washers all 1/32" thick in sizes from 1/4" to 1-1/2". Packed in a transparent, plastic box.



papco SPRING TENSION WASHERS



These heat treated spring steel washers are used to eliminate rattles in rods and connecting levers and to take up side play and lost motion in carburetor linkage, clevis yokes, brake shoe pins and gear shift rods etc.

Order by Stock Number

| Stock No. | Shaft Dia. |
|-----------|------------|
| 162-963 | 3/16 |
| 162-964 | 1/4 |
| 162-965 | 5/16 |
| 162-966 | 3/8 |
| 162-967 | 7/16 |
| 162-968 | 1/2 |

SPRING TENSION WASHER UTILITY ASSORTMENT No. 020-351

Contains 210 Tension Washers. 35 each of six sizes in a sturdy, fibreboard container with individual compartments.



Standard Package 100 pieces.

papco COUNTERSUNK FINISHING WASHERS



Standard Type

"PAPCO" Countersunk Finishing Washers are made from sheet brass and nickel plated. Used in body trim work with countersunk head screws and bolts.



Flush Type

Standard Package 100 Washers

| COUNTERSUNK STANDARD TYPE | | | |
|---------------------------|------------|-------------|--------------|
| Stock No. | Screw Size | Inside Dia. | Outside Dia. |
| 162-971 | #6 | .167 | 7/16 |
| 162-973 | #8 | .193 | 1/2 |
| 162-975 | #10 | .228 | 19/32 |
| 162-977 | #12 | .291 | 11/16 |
| 162-979 | 1/4 | .318 | 25/32 |
| COUNTERSUNK FLUSH TYPE | | | |
| 162-988 | #8 | 13/64 | 13/32 |
| 162-990 | #10 | 13/64 | 15/32 |
| 162-994 | 1/4 | 17/64 | 5/8 |

papco FINISHING WASHER GARAGE ASSORTMENT No. 020-030

Contains 200 Nickel Plated Finishing Washers used with Countersunk Head Screws.

Sizes from No. 6 to 1/4".

Packed in a sturdy, clear plastic container.



papeo® STOVE BOLTS BOULONS DE POELE



195
Flat

FLAT HEAD



BRIGHT
PLATED

ROUND HEAD



196
Round



BRIGHT ELECTRO PLATED

Order by Stock Number

Standard Package 100 Bolts and Nuts.

| Stock Numbers | | | Stock Numbers | | | Stock Numbers | | | Stock Numbers | | |
|---------------|---------|-------------|---------------|---------|--------------|---------------|---------|-------------|---------------|---------|--------------|
| Flat | Round | Size | Flat | Round | Size | Flat | Round | Size | Flat | Round | Size |
| 195-087 | 196-087 | 1/8 x 1/2 | 195-195 | 196-195 | 3/16 x 1-1/4 | 195-307 | 196-307 | 1/4 x 3/4 | 195-444 | 196-444 | 5/16 x 1 |
| 195-089 | 196-089 | 1/8 x 3/4 | 195-197 | 196-197 | 3/16 x 1-1/2 | 195-309 | 196-309 | 1/4 x 1 | 195-448 | 196-448 | 5/16 x 1-1/2 |
| 195-091 | 196-091 | 1/8 x 1 | 195-199 | 196-199 | 3/16 x 1-3/4 | 195-311 | 196-311 | 1/4 x 1-1/4 | 195-451 | 196-451 | 5/16 x 2 |
| 195-093 | 196-093 | 1/8 x 1-1/4 | 195-200 | 196-200 | 3/16 x 2 | 195-313 | 196-313 | 1/4 x 1-1/2 | 195-453 | 196-453 | 5/16 x 2-1/2 |
| 195-095 | 196-095 | 1/8 x 1-1/2 | 195-202 | 196-202 | 3/16 x 2-1/2 | 195-315 | 196-315 | 1/4 x 1-3/4 | 195-455 | 196-455 | 5/16 x 3 |
| 195-189 | 196-189 | 3/16 x 1/2 | 195-204 | 196-204 | 3/16 x 3 | 195-316 | 196-316 | 1/4 x 2 | 195-493 | 196-493 | 3/8 x 1-1/2 |
| 195-191 | 196-191 | 3/16 x 3/4 | 195-305 | 196-305 | 1/4 x 1/2 | 195-317 | 196-317 | 1/4 x 2-1/4 | 195-496 | 196-496 | 3/8 x 2 |
| 195-193 | 196-193 | 3/16 x 1 | 195-306 | 196-306 | 1/4 x 5/8 | 195-318 | 196-318 | 1/4 x 2-1/2 | 195-498 | 196-498 | 3/8 x 2-1/2 |
| | | | | | | 195-320 | 196-320 | 1/4 x 3 | 195-500 | 196-500 | 3/8 x 3 |

For Slot Drive Stove Bolts see current Price Book.

papeo® STOVE BOLTS ASSORTMENTS ASSORTIMENTS DE BOULONS DE POELE

GARAGE ASSORTMENT No. 020-044 ROUND HEAD

Contains 68 Stove Bolts from
3/16" x 1/2" to 1/4" x 2".



GARAGE ASSORTMENT No. 020-045 FLAT HEAD

Contains 68 Stove Bolts from
3/16" x 1/2" to 1/4" x 2".

Packed in rigid, transparent, plastic containers

STOVE BOLT UTILITY ASSORTMENT No. 020-324

Contains 200 Round Head Stove Bolts, from
3/16" x 1/2" to 1/4" x 2".

UTILITY ASSORTMENT No. 020-323

Contains 80 Round Head Stove Bolts, 6 sizes:
3/16" x 4", 5", 6";
1/4" x 4", 5", 6".

These assortments are packed in sturdy fibreboard
containers. Each size is in a separate compartment.
Retail prices are shown on lid label. Assortment can
be refilled from Standard Packages.



STOVE BOLT and MACHINE SCREW EQUIVALENT SIZES

| STOVE BOLT DIAMETER | 1/8" | 5/32" | 3/16" | 1/4" | 5/16" | 3/8" |
|---------------------|------|-------|-------|--------|---------|--------|
| MACHINE SCREW SIZE | 6-32 | 8-32 | 10-24 | 1/4-20 | 5/16-18 | 3/8-16 |



papco[®] MACHINE SCREWS VIS DE MECANIQUE

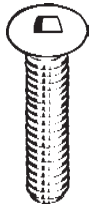

174
Round

‘LOXXON’ SQUARE SOCKET DRIVE
BRIGHT ELECTRO PLATED

“PAPCO” MACHINE SCREWS are used on window moulding, door handles, instrument panels, lamp rims and many other applications.



176
Flat

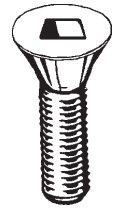

Order by Stock Number

Standard Package 100 pieces.

| "Papco" Stock Number | | Screw Dia. | Threads per Inch | Screw Length | Decimal Equiv. of Dia. | "Papco" Stock Number | | Screw Dia. | Threads per Inch | Screw Length | Decimal Equiv. of Dia. |
|----------------------|---------|------------|------------------|--------------|------------------------|----------------------|---------|------------|------------------|--------------|------------------------|
| Round | Flat | | | | | Round | Flat | | | | |
| 174-039 | | 4 | 40 | 1/4 | .112" | 174-189 | 176-189 | 10 | 24 | 1/2 | .190" |
| 174-043 | | | | 1/2 | | 3/4 | | | | | |
| 174-083 | | 6 | 32 | 1/4 | .138" | 174-193 | 176-193 | 10 | 32 | 1 | .190" |
| 174-085 | 176-085 | | | 3/8 | | 1-1/4 | | | | | |
| 174-087 | 176-087 | | | 1/2 | | 1-1/2 | | | | | |
| 174-089 | 176-089 | | | 3/4 | | | | | | | |
| 174-091 | 176-091 | | | 1 | | | | | | | |
| 174-093 | 176-093 | | | 1-1/4 | | | | | | | |
| 174-095 | 176-095 | 1-1/2 | | | | | | | | | |
| 174-133 | | 8 | 32 | 1/4 | .164" | 174-213 | | 10 | 32 | 1/4 | .190" |
| 174-135 | 176-135 | | | 3/8 | | 1-1/4 | | | | | |
| 174-137 | 176-137 | | | 1/2 | | 1-1/2 | | | | | |
| 174-139 | 176-139 | | | 3/4 | | | | | | | |
| 174-141 | 176-141 | | | 1 | | | | | | | |
| 174-143 | 176-143 | | | 1-1/4 | | | | | | | |
| 174-145 | 176-145 | 1-1/2 | | | | | | | | | |
| 174-185 | | 10 | 24 | 1/4 | .190" | 174-219 | 176-219 | 1/4 | 20 | 3/4 | .250" |
| 174-187 | 176-187 | | | 3/8 | | 1-1/2 | | | | | |
| | | | | | | 2 | | | | | |

For Slot Drive Machine Screws see current Price Book.

184
Series

papco[®] HEX MACHINE SCREW NUTS ECROUS DE VIS DE MECANIQUE

BRIGHT ELECTRO PLATED



Order by Stock Number

Standard Package 100 pieces.

| "Papco" Stock No. | Size | Threads per Inch | Dimensions | | "Papco" Stock No. | Size | Threads per Inch | Dimensions | |
|-------------------|------|------------------|--------------|-----------|-------------------|------|------------------|--------------|-----------|
| | | | Across Flats | Thickness | | | | Across Flats | Thickness |
| 184-004 | 4 | 40 | 1/4 | 3/32 | 184-011 | 10 | 32 | 3/8 | 1/8 |
| 184-005 | 5 | 40 | 5/16 | 7/64 | 184-012 | 12 | 24 | 7/16 | 5/32 |
| 184-006 | 6 | 32 | 5/16 | 7/64 | 184-014 | 1/4 | 20 | 7/16 | 3/16 |
| 184-008 | 8 | 32 | 11/32 | 1/8 | 184-015 | 1/4 | 28 | 7/16 | 3/16 |
| 184-010 | 10 | 24 | 3/8 | 1/8 | | | | | |

papco[®] MACHINE SCREWS ASSORTMENTS ASSORTIMENTS VIS DE MECANIQUE

‘LOXXON’ SQUARE SOCKET DRIVE

**GARAGE ASSORTMENT
No. 020-010**

Round Head

Contains 130 Round Head Plated Machine Screws in various sizes and 45 Hexagon Plated Nuts.



**GARAGE ASSORTMENT
No. 020-011**

Flat Head

Contains 130 Flat Head Plated Machine Screws in various sizes and 45 Hexagon Plated Nuts.

Packed in rigid, transparent, plastic containers.



MACHINE SCREW ASSORTMENTS ASSORTIMENTS DE VIS DE MECANIQUE



UTILITY ASSORTMENT No. 020-331

Round Head Square Drive Machine Screws.

Contains 320 Round Head Machine Screws and Nuts.
16 sizes from 4-40 x 1/2" to 10-32 x 1-1/2".

UTILITY ASSORTMENT No. 020-333

Flat Head Square Drive Machine Screws.

Contains 350 Flat Head Machine Screws and Nuts.

Screws – 6-32 x 3/8, 8-32" to 1/4" x 1-1/2".

Nuts – 6-32, 8-32, 10-24, 1/4".

These assortments are packed in sturdy fibreboard metal edged boxes with individual compartments and with illustrated labels showing parts and retail codes.



Metal Merchandiser with
moulded compartments.

Size: 9-3/4" w. x 13-3/4" l. x 2" d.

SQUARE DRIVE MACHINE SCREW and NUT MASTER ASSORTMENT No. 020-624

- Contains 1120 pieces - 32 sizes, Round and Flat Head and Hexagon Nuts.
- Metal box with moulded plastic compartments.
- Safety snap carrying handle.
- Actual size illustrations and retail price codes of every item shown on grease-resistant lid label.
- Refills available in standard packages of 100.

A practical assortment that gives complete coverage of all popular sizes of Machine Screws and Nuts.

papeo SUPER SERVICE ASSORTMENT No. 020-806

MACHINE SCREW and NUT SUPER-SERVICE ASSORTMENT No. 020-806

- Contains 2750 pieces - 32 sizes, Round and Flat Head Square Drive Machine Screws with Nuts.
- Large size, rigid metal box with high-strength plastic compartments.
- Convenient, safety snap carrying handle.
- Actual size illustrations and retail codes of every item shown on grease-resistant lid label.
- Refills available in standard packages of 100.

Perfect for Dealers, Jobbers and large users. This popular assortment has a wide range of carefully selected Machine Screws and Nuts in balanced quantities.



Size: 12" w. x 18" l. x 3" d.

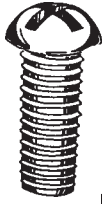

papco PHILLIPS MACHINE SCREWS VIS DE MECANIQUE PHILLIPS



BRIGHT PLATED

Phillips Type (cross recessed) screws are used on all trim applications.

173
Round
Head

175
Oval
Head

Order by Stock Number

Standard Package 100 pieces

| Papco Stock Nos. | | Screw Diameter | Threads Per Inch | Screw Length | Decimal Equivalent |
|------------------|---------|----------------|------------------|--------------|--------------------|
| Round | Oval | | | | |
| 173-085 | | 6 | 32 | 3/8" | .138" |
| 173-135 | | 8 | 32 | 3/8" | |
| 173-137 | 175-137 | | | 1/2" | .164" |
| 173-139 | 175-139 | | | 3/4" | |
| 173-141 | 175-141 | | | 1" | |
| 173-189 | | 10 | 24 | 1/2" | |
| 173-191 | 175-191 | | | 3/4" | .190" |
| 173-193 | | | | 1" | |
| 173-215 | | 10 | 32 | 3/8" | |
| 173-217 | 175-217 | | | 1/2" | .190" |
| 173-219 | | | | 3/4" | |
| 173-305 | | 1/4 | 20 | 1/2" | |
| 173-307 | 175-307 | | | 3/4" | .250" |
| 173-309 | | | | 1" | |

papco PHILLIPS MACHINE SCREW ASSORTMENTS



MASTER ASSORTMENT No. 020-623

- Contains 786 pieces – 20 sizes. Round and Oval Head and Hexagon Nuts.
- Rigid, metal box with handy moulded compartments.
- Carrying handle with safety snap lock.
- Illustrated lid label shows retail codes.
- Refills available in standard packages.

GARAGE ASSORTMENT No. 020-012 Round Head

Assortment contains 100 Plated Phillips Head Machine Screws and 50 Hexagon Plated Nuts in popular sizes.

Packed in a rigid, transparent plastic container.

Order by Stock Number.





197
Flat
Steel



Papco WOOD SCREWS VIS A BOIS

'LOXXON' SQUARE SOCKET DRIVE

"Papco" Wood Screws are available in over 300 stock sizes in Brass and Steel and in various Head Styles and Drives. All 'Papco' Steel Wood Screws listed here are Bright Plated.



198
Round
Steel

204
Round
Brass

203
Flat
Brass

Flat Socket Steel add prefix 197
Flat Socket Brass add prefix 203



Round Socket Steel add prefix 198
Round Socket Brass add prefix 204

Example of Stock No. 197-139 is 8 x 3/4 Flat Socket Steel Wood Screws Plated.
Example of Stock No. 203-139 is 8 x 3/4 Flat Socket Brass Wood Screws.

Order by Stock Number

Standard Package 100 Screws

| Diameter | No. 4 | No. 5 | No. 6 | No. 7 | No. 8 | No. 9 | No. 10 | No. 12 | No. 14 |
|----------------------------|-------|-------|-------|-------|-------|-------|--------|--------|-------------------|
| Decimal Equiv. of Diameter | .112 | .125 | .138 | .155 | .165 | .177 | .191 | .218 | .251 |
| Drill Pilot Hole* | 3/64 | 1/16 | 1/16 | 1/16 | 5/64 | 5/64 | 3/32 | 7/64 | 7/64 |
| Drill Shank Hole* | 7/64 | 1/8 | 9/64 | 5/32 | 11/64 | 3/16 | 3/16 | 7/32 | 1/4 |
| Length | | | | | | | | | |
| 1/2 | -043 | -063 | -087 | -111 | -137 | | | | STEEL SOCKET ONLY |
| 5/8 | -044 | -064 | -088 | -112 | -138 | | | | |
| 3/4 | -045 | -065 | -089 | -113 | -139 | | -191 | | |
| 1 | -047 | -067 | -091 | -115 | -141 | -167 | -193 | -250 | -280 |
| 1-1/4 | | | -093 | -117 | -143 | -169 | -195 | -252 | -282 |
| 1-1/2 | | | -095 | -119 | -145 | -171 | -197 | -254 | -284 |
| 1-3/4 | | | | | | | -199 | | -286 |
| 2 | | | | | -148 | | -200 | -257 | -287 |
| 2-1/2 | | | | | -150 | | -202 | -259 | -289 |
| 3 | | | | | | | -204 | -261 | -291 |

* Sizes of holes recommended for average application. Slightly larger or smaller holes may be required for hard or soft woods.

Note: Additional sizes of Wood Screws in Steel, Brass, Stainless Steel and Silicon Bronze are available - see current Non-Ferrous catalogue.

Papco WOOD SCREWS ASSORTMENTS ASSORTIMENTS DE VIS A BOIS

GARAGE ASSORTMENT

No. 020-201

STEEL

Contains 160 pieces - 8 sizes of Flat Socket Head Steel Wood Screws Plated. Packed in a transparent plastic box.



GARAGE ASSORTMENT

No. 020-210

BRASS

Contains 155 pieces - 8 sizes of mostly Flat and Round Socket Head Brass Wood Screws from 6 x 1/2 to 8 x 1-1/2. Packed in a transparent plastic box.



UTILITY ASSORTMENT

No. 020-354

STEEL

Contains 460 pieces Flat and Round Socket Steel Wood Screws Plated. Twelve sizes from No. 4 x 1/2 to No. 10 x 1-1/2. Strong display box with moulded plastic compartments. Refills available in standard packages.



UTILITY ASSORTMENT

No. 020-356

BRASS

Contains 380 pieces Flat and Round Socket Brass Wood Screws. Twelve sizes from No. 4 x 1/2 to No. 10 x 1-1/2. Packed in a sturdy fibre - board container.

MASTER ASSORTMENT

No. 020-600

STEEL

Contains 850 pieces Flat and Round Socket Steel Wood Screws Plated. Twelve sizes from No. 4 x 1/2 to No. 10 x 1-1/2. Packed in a metal box with moulded plastic compartments.

MASTER ASSORTMENT

No. 020-601

BRASS

Contains 735 pieces Flat and Round Socket Brass Wood Screws. Twelve sizes from No. 4 x 1/2 to No. 10 x 1-1/2. Packed in a metal box with moulded plastic compartments.



Papco TAPPING SCREWS VIS TARAUEUSES



SHEET METAL SCREWS SLOT HEAD BRIGHT PLATED

205
Pan
Head

SELF-TAPPING



HARDENED

206
Oval
Head

"Papco" Sheet Metal Screws are used in the assembly of sheet metal parts and for making fastenings to sheet metal. They are used in body work for attaching window moulding, trim, panels, metal drip moulding and many other applications.

Order by Stock Number

Standard Package 100 pieces.

| Pan Head Stock No. | Oval Head Stock No. | Screw Dia. | Screw Length | Decimal Eq. of Dia. | Drill Hole | Pan Head Stock No. | Oval Head Stock No. | Screw Dia. | Screw Length | Decimal Eq. of Dia. | Drill Hole |
|--------------------|---------------------|------------|--------------|---------------------|------------|--------------------|---------------------|------------|--------------|---------------------|------------|
| 205-039 | | | 1/4 | | | 205-187 | | | 3/8 | | |
| 205-041 | | 4 | 3/8 | .112" | 5/64" | 205-189 | 206-189 | | 1/2 | | |
| 205-043 | 206-043 | | 1/2 | | | 5/8 | | | | | |
| 205-044 | 206-044 | | 5/8 | | | 3/4 | .191" | 9/64" | | | |
| 205-083 | | | 1/4 | | | | | | | | |
| 205-085 | 206-085 | 6 | 3/8 | .138" | 3/32" | 205-193 | 206-193 | | 1 | | |
| 205-087 | 206-087 | | 1/2 | | | 1-1/4 | | | | | |
| 205-088 | 206-088 | | 5/8 | | | 1-1/2 | | | | | |
| 205-089 | 206-089 | | 3/4 | | | 5/8 | | | | | |
| 205-091 | 206-091 | | 1 | | | 3/4 | .218" | 5/32" | | | |
| 205-093 | 206-093 | | 1-1/4 | | | 1 | | | | | |
| 205-135 | | | 3/8 | | | 1-1/2 | | | | | |
| 205-137 | 206-137 | | 1/2 | | | 1-1/2 | | | | | |
| 205-138 | 206-138 | 5/8 | 3/4 | .251" | 3/16" | | | | | | |
| 205-139 | 206-139 | 8 | 3/4 | .165" | 1/8" | 205-278 | 206-278 | | 3/4 | | |
| 205-141 | 206-141 | | 1 | | | 1 | | | | | |
| 205-143 | 206-143 | | 1-1/4 | | | 1-1/4 | | | | | |
| 205-145 | | | 1-1/2 | | | 1-1/2 | | | | | |
| | | | | | | 1 | | | | | |
| | | | | | | 1-1/4 | | | | | |

223
Series

Papco THREAD CUTTING SCREWS VIS A FILETAGE COUPANT

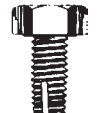

TYPE 1 SCREWS
BRIGHT PLATED

Round Hexagon

These hardened screws cut their own Standard Machine Screw Thread in any metal. The off-centre thread cutting slot acts as a tap when the screw is driven. 'Papco' Thread Cutting Screws are ideal to have on hand when stripped threads need repair.

Order by Stock Number

Standard Package 100 pieces.

| Stock No. | Size | Head Type | Decimal Dia. | Drill Hole |
|-----------|---------------|-----------|--------------|------------|
| 223-010 | 4-40 x 3/8 | Round | .112" | #43 |
| 223-014 | 6-32 x 3/8 | Pan | | |
| 223-016 | 6-32 x 1/2 | Round | .138" | #34 (.111) |
| 223-022 | 6-32 x 3/4 | Round | | |
| 223-034 | 8-32 x 3/8 | Round | | |
| 223-037 | 8-32 x 1/2 | Round | .164" | #28 (.140) |
| 223-043 | 8-32 x 3/4 | Round | | |
| 223-058 | 10-24 x 1/2 | Round | .190" | #21 (.159) |
| 223-068 | 10-24 x 1 | Pan | | |
| 223-079 | 10-32 x 1/2 | Round | | |
| 223-086 | 10-32 x 3/4 | Round | .190" | #19 (.166) |
| 223-103 | 12-24 x 1/2 | Round | .216" | 3/16 |
| 223-120 | 1/4-20 x 1/2 | Round | .250" | 7/32 |
| 223-131 | 1/4-20 x 1 | Hex | | |
| 223-143 | 5/16-18 x 1/2 | Hex | | |
| 223-152 | 5/16-18 x 1 | Hex | .312" | 9/32 |



THREAD CUTTING SCREW ASSORTMENT No. 020-856

- Contains 250 Screws, 16 sizes.
- Needed in every shop and Service Department
- Like having a set of Machine Screw Size Taps.
- Cuts all threads from 4-40 to 5/16-18.
- Rigid, plastic compartmentized container.

papco® TAPPING SCREW ASSORTMENTS ASSORTIMENTS VIS TARAUDEUSES



GARAGE ASSORTMENT No. 020-024

HEXAGON HEAD

Contains 100 Hexagon Head Tapping Screws in various lengths and diameters from 8 x 1/2 to 5/16 x 1.



GARAGE ASSORTMENT No. 020-026

PAN SLOT

Contains 165 Pan Slot Head Tapping Screws in various lengths and diameters from 4 x 1/2 to 14 x 1.

GARAGE ASSORTMENT No. 020-200

PAN SOCKET

Contains 175 Pan Socket Head Tapping Screws in various lengths and diameters from 6 x 1/2 to 10 x 1.

TAPPING SCREW UTILITY ASSORTMENT No. 020-312

SLOT

Contains 495 pieces – 18 sizes, Pan and Oval Slot Heads. Packed in a sturdy fibreboard container with plastic tray. Actual size illustrations and retail price codes of every item shown on lid label.



No. 020-312
Size: 7-1/2" x 12" x 1-1/4"

TAPPING SCREW UTILITY ASSORTMENT No. 020-353

SOCKET

Contains 500 pieces – 16 sizes, Pan Socket Head. Packed in a sturdy fibreboard container with moulded plastic trays. Refills available in standard packages.

Here are two assortments of "Papco: Sheet Metal Screws designed especially for Dealers, Service Stations and Garages. Use these attractive, permanent merchandisers to increase your sales – and profits – on this fast moving line!

TAPPING SCREW MASTER ASSORTMENT No. 020-612

SLOT

Contains 937 pieces – 18 sizes of Pan, Oval and Hex Slot Tapping Screws. Metal box with moulded plastic compartments and hinged lid. Actual size illustrations on lid label. Refills available in standard packages.



Metal Merchandiser with moulded compartments
Size: 9-3/4" w. x 13-3/4" l. x 2" d.

No. 020-612

TAPPING SCREW MASTER ASSORTMENT No. 020-660

SOCKET

Contains 1000 pieces — 25 sizes of Pan Socket Head Tapping Screws. Packed in a metal box with high-strength plastic compartments. Actual size illustrations and retail price codes of every item shown on grease-resistant lid label.



TAPPING SCREW MASTER ASSORTMENT No. 020-615

Excellent assortment of Hexagon Steel Metal Screws and Fender Washers for the well-equipped Body Shop

- Contains 280 Hexagon Head Screws
125 Flat Fender Washers
20 Popular Sizes

Size: 9-3/4" w. x 13-3/4" l. x 2" d.

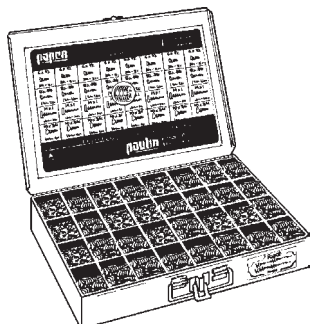

papco SUPER SERVICE ASSORTMENT No. 020-807

Contains 1450 Pan and Oval Slot Head Tapping Screws — 32 items. Large size, rigid metal box with high-strength plastic compartments.

For more details see page 9.

Large size: 12" w. x 18" l. x 3" d.



papco

**SOCKET TAPPING SCREWS
VIS TARAUEUSES CREUSE**

'LOXXON'® SQUARE SOCKET DRIVE

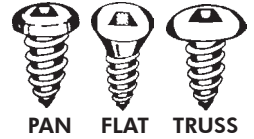

208
Pan Head

209
Flat Head

210
Truss Head

SHEET METAL SCREWS

SELF-TAPPING



BRIGHT PLATED

HARDENED

Specify "Papco" Pan, Flat or Truss Socket Head Tapping Screws where a positive driver engagement, or where high-speed assembly of sheet metal parts, is required. They are used in body work, mouldings, trim, sheet metal work and many other applications.

Order by Stock Number

Standard Package 100 pieces.

| Pan Head Stock No. | Flat Head Stock No. | Truss Hd. Stock No. | Screw Dia. | Screw Length | Decimal Eq. of Dia. | Drill Hole | Pan Head Stock No. | Flat Head Stock No. | Truss Hd. Stock No. | Screw Dia. | Screw Length | Decimal Eq. of Dia. | Drill Hole |
|--------------------|---------------------|---------------------|------------|--------------|---------------------|------------|--------------------|---------------------|---------------------|------------|--------------|---------------------|------------|
| 208-039 | | | | 1/4 | | | 208-187 | | | | 3/8 | | |
| 208-041 | 209-041 | | | 3/8 | | | 208-189 | 209-189 | 210-189 | | 1/2 | | |
| 208-043 | 209-043 | | 4 | 1/2 | .112" | 5/64" | 208-190 | 209-190 | 210-190 | | 5/8 | | |
| 208-045 | 209-045 | | | 3/4 | | | 208-191 | 209-191 | 210-191 | 10 | 3/4 | .191" | 9/64" |
| 208-047 | 209-047 | | | 1 | | | 208-193 | 209-193 | 210-193 | | 1 | | |
| 208-083 | | | | 1/4 | | | 208-195 | 209-195 | 210-195 | | 1-1/4 | | |
| 208-085 | 209-085 | 210-085 | | 3/8 | | | 208-197 | 209-197 | | | 1-1/2 | | |
| 208-087 | 209-087 | 210-087 | | 1/2 | | | 208-200 | 209-200 | | | 2 | | |
| 208-088 | 209-088 | 210-088 | 6 | 5/8 | .138" | 3/32" | 208-246 | 209-246 | | | 1/2 | | |
| 208-089 | 209-089 | 210-089 | | 3/4 | | | 208-248 | 209-248 | | | 3/4 | | |
| 208-091 | 209-091 | 210-091 | | 1 | | | 208-250 | 209-250 | | 12 | 1 | .218" | 5/32" |
| 208-093 | 209-093 | | | 1-1/4 | | | 208-252 | 209-252 | | | 1-1/4 | | |
| 208-095 | 209-095 | | | 1-1/2 | | | 208-254 | 209-254 | | | 1-1/2 | | |
| 208-135 | | 210-135 | | 3/8 | | | 208-257 | | | | 2 | | |
| 208-137 | 209-137 | 210-137 | | 1/2 | | | 208-277 | 209-277 | | | 5/8 | | |
| 208-138 | 209-138 | 210-138 | | 5/8 | | | 208-278 | 209-278 | | | 3/4 | | |
| 208-139 | 209-139 | 210-139 | 8 | 3/4 | .165" | 1/8" | 208-280 | 209-280 | | 14 | 1 | .251" | 3/16" |
| 208-141 | 209-141 | 210-141 | | 1 | | | 208-282 | 209-282 | | | 1-1/4 | | |
| 208-143 | 209-143 | 210-143 | | 1-1/4 | | | 208-284 | 209-284 | | | 1-1/2 | | |
| 208-145 | 209-145 | 210-145 | | 1-1/2 | | | 208-287 | 209-287 | | | 2 | | |
| 208-148 | 209-148 | | | 2 | | | | | | | | | |

213
Hex Head

papco

**HEX HEAD TAPPING SCREWS
VIS TARAUEUSES TETE HEX**



PLATED

SELF-TAPPING

HARDENED

Oversize Hexagon Washer Heads to fit Automotive Cap Screw Wrenches.

Order by Stock Number

Standard Package 100 pieces.

| 'Papco' Stock No. | Screw Dia. | Screw Length | Decimal Eq. of Dia. | Across Flats | Drill Hole | 'Papco' Stock No. | Screw Dia. | Screw Length | Decimal Eq. of Dia. | Across Flats | Drill Hole |
|-------------------|------------|--------------|---------------------|--------------|------------|-------------------|------------|--------------|---------------------|--------------|------------|
| 213-085 | 6 | 3/8 | .138" | 1/4" | 3/32" | 213-250 | 12 | 1 | .218" | 5/16" | 5/32" |
| 213-137 | | 1/2 | | | | 213-276 | | 1/2 | | | |
| 213-139 | | 3/4 | | | | 213-277 | | 5/8 | | | |
| 213-141 | 8 | 1 | .165" | 1/4" | 1/8" | 213-278 | 14 | 3/4 | .251" | 7/16" | 3/16" |
| 213-143 | | 1-1/4 | | | | 213-280 | | 1 | | | |
| 213-145 | | 1-1/2 | | | | 213-282 | | 1-1/4 | | | |
| 213-187 | | 3/8 | | | | 213-284 | | 1-1/2 | | | |
| 213-189 | | 1/2 | | | | 213-442 | | 3/4 | | | |
| 213-190 | 10 | 5/8 | .191" | 5/16" | 9/64" | 213-444 | 5/16 | 1 | .312" | 1/2" | 9/32" |
| 213-191 | | 3/4 | | | | 213-446 | | 1-1/4 | | | |
| 213-193 | | 1 | | | | 213-448 | | 1-1/2 | | | |
| 213-246 | 12 | 1/2 | .218" | 5/16" | 5/32" | 213-489 | 3/8 | 1 | .375" | 9/16" | 11/32" |
| 213-248 | | 3/4 | | | | 213-493 | | 1-1/2 | | | |

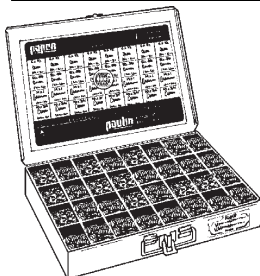

papco

SUPER SERVICE ASSORTMENT No. 020-808

Contains 650 Hexagon Head Tapping Screws and Fender Washers. Large size, rigid metal box with high-strength plastic compartments.

For more details see page 9.

Large size: 12" w. x 18" l. x 3" d.



140
Carded

papeco POWER DRIVER BITS POINTES DE TOURNEVIS

• 2 PIECE CONSTRUCTION • 'LOXXON' SQUARE DRIVE

8140
Packaged

'Papco' 'Loxxon' Square Drive Bits are precision crafted from impact resistant tool steel and offer the best combination of hardness and toughness for maximum durability. Available in 1, 2, 3, 4 and 6 inch lengths.

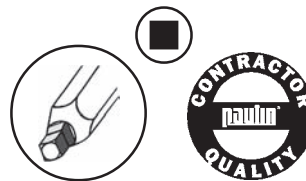

S2 STEEL

Order by Stock Number

Individually Carded* or Packaged

| Bit Size | 1" Long | | | 2" Long | | | 3" Long | 4" Long | 6" Long | Fits Screw Dia. |
|----------|------------------|--------------------|-----------|------------------|--------------------|-----------|------------------|------------------|------------------|-----------------|
| | Carded Stock No. | Packaged Stock No. | Std. Pkg. | Carded Stock No. | Packaged Stock No. | Std. Pkg. | Carded Stock No. | Carded Stock No. | Carded Stock No. | |
| No. 0 | 140-310* | — | — | — | — | — | — | — | — | No.3 & 4 |
| No. 1 | 140-311* | 8140-311 | 10 | 140-321 | 8140-321 | 10 | 140-331 | 140-341 | 140-361 | No.5 to 7 |
| No. 2 | 140-312* | 8140-312 | 25 | 140-322 | 8140-322 | 10 | 140-332 | 140-342 | 140-362 | No.8 to 10 |
| No. 3 | 140-313* | 8140-313 | 10 | 140-323 | 8140-323 | 10 | 140-333 | 140-343 | 140-363 | No.12 & 14 |

* Indicates 2 bits per card

Available in Bulk - price on application.

140
Carded

papeco POWER DRIVER BITS POINTES DE TOURNEVIS

PHILLIPS DRIVE

8140
Packaged

'Papco' Phillips Drive bits are made of the same impact resistant hardened tool steel as the Loxxon Square Drive Bits for maximum performance.

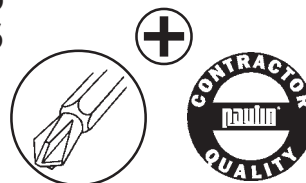

Order by Stock Number

Individually Carded* or Packaged

| Bit Size | 1" Long | | | 2" Long | | | 3" Long | 4" Long | Fits Screw Dia. |
|----------|------------------|--------------------|-----------|------------------|--------------------|-----------|------------------|------------------|-------------------|
| | Carded Stock No. | Packaged Stock No. | Std. Pkg. | Carded Stock No. | Packaged Stock No. | Std. Pkg. | Carded Stock No. | Carded Stock No. | |
| No. 1 | 140-411* | 8140-411 | 10 | 140-421 | 8140-421 | 10 | — | — | No.2 to 4 |
| No. 2 | 140-412* | 8140-412 | 25 | 140-424 | 8140-424 | 10 | — | — | No.5 to 10 |
| No. 3 | 140-413* | 8140-413 | 10 | 140-423 | 8140-423 | 10 | — | — | No.12 to 16 |
| Drywall | 140-422* | 8140-422 | 25 | — | — | — | — | — | All Drywall Scrs. |

* Indicates 2 bits per card

Available in Bulk - price on application.

8020
Series

papeco ASSORTED BIT KITS JEUX DES POINTE ASSORTIS



8020-900

Choose from 4 skin-packed Assorted Bit Kits each containing No. 1, 2 and 3 bit sizes in either 'Loxxon' Square Drive or Phillips in either 1" or 2" bit lengths.



1" 'LOXXON' SQUARE DRIVE ASSORTED BITS KIT No. 8020-900



2" 'LOXXON' SQUARE DRIVE ASSORTED BITS KIT No. 8020-901



1" PHILLIPS DRIVE ASSORTED BITS KIT No. 8020-902



2" PHILLIPS DRIVE ASSORTED BITS KIT No. 8020-903

7 Pc. BIT ASSORTMENT No. 8020-907

Contains six 1" long 'Loxxon' Square Drive and Phillips Drive bits in No. 1, 2 and 3 bit sizes - plus a 1/4 x 3" magnetic Bit Holder in a clear plastic pack.

14 Pc. BIT ASSORTMENT No. 8020-915

Contains six 1" and 2" long 'Loxxon' Square Drive bits - six 1" and 2" long Phillips Drive bits in No. 1, 2 and 3 bit sizes - plus two 6-Lobe bits in a see-through plastic pack.

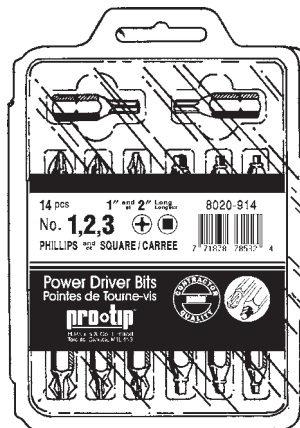

8020-915



222
Series

papeco BIT ACCESSORIES ACCESSORIE DE POINTES

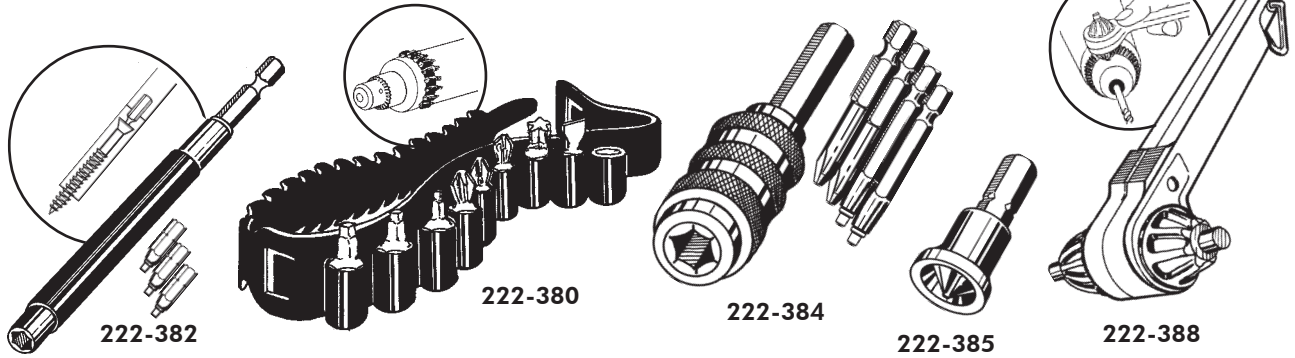

Order by Stock Number

Individually Skin-packed

| Stock No. | Description |
|-----------|---|
| 222-380 | Power Bit Belt - straps to most power drills - Includes 9 assorted bits including 6-Lobe |
| 222-382 | Screw Starter Driver - sliding guide sleeve over magnetic chuck - includes 3 square drive bits |
| 222-384 | Quick Change Chuck - includes four 2" long assorted 'Loxxon' and Phillips bits (No. 1 and 2 Points) |
| 222-385 | Drywall Screw Dimpler - includes Drywall Screw Bit |
| 222-388 | Ratchet Key - chuck key for most power drills and bench tools - fast bit change-overs |

papeco CARDED BIT MERCHANDISER No. 022-154

Contains 11 sizes of 1, 2 and 3 inch long carded bits in No. 1 to 3 'Loxxon' Square and Phillips Drives - plus two sizes of 6-Lobe Drive Bits. Also includes Assorted Bit Kits No. 8020-900, 901, 902 and 903 of 1 and 2 inch long Square and Phillips Bits. Magnetic Bit Holder 222-355, 6 in 1 Magnetic Screwdriver 222-995 and Magnetic 6-Lobe Screwdriver 231-975 for a grand total of 20 items - 54 cards on an attractive, point-of-purchase display rack that can be hung on a wall or displayed on a counter.

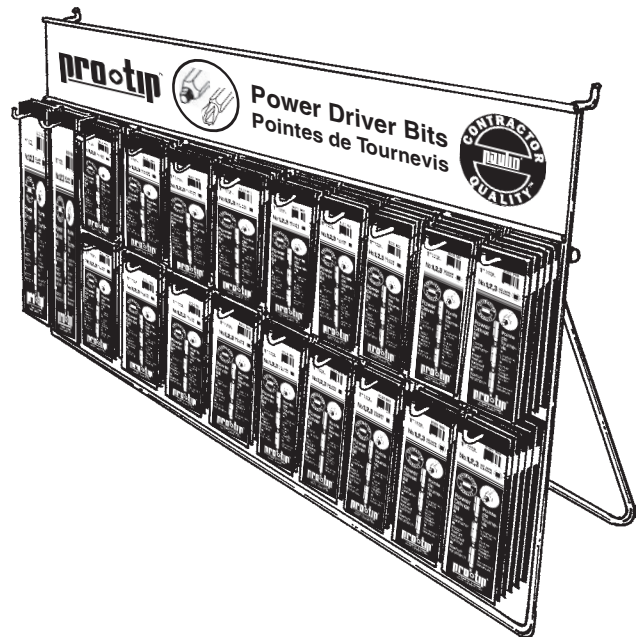

papeco 7 Pc. POCKET KIT SCREWDRIVERS

Injection molded plastic hinged kit features No. 1 and No. 2 'Loxxon' Square Drive Bits and Phillips Bits, 8-10 Slot Bit, T-15 6-Lobe Bit and a 2" Magnetic Bit Holder. Handy belt clip attached.

Order by Stock Number Individually Carded

| Stock No. | Colour | Stock No. | Colour |
|-----------|--------|-----------|--------|
| 020-923 | Green | 020-926 | Red |
| 020-924 | Yellow | 020-927 | Black |
| 020-925 | Orange | | |

POCKET KIT COUNTER DISPLAY No. 020-928
Contains 24 Pocket Screwdriver Kits No. 020-927 in an attractive counter display box.

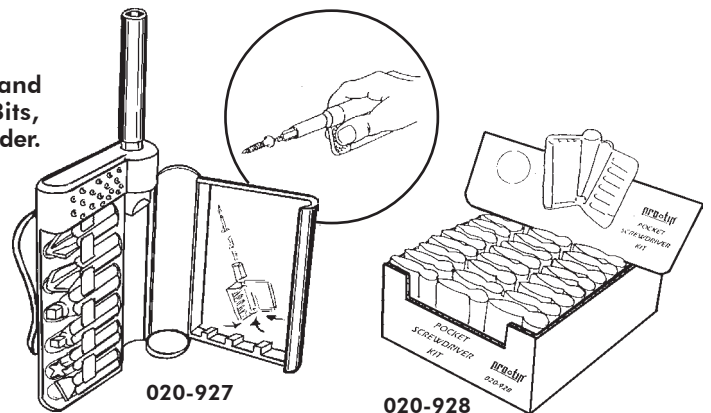

140
Series

papco® **SCREWDRIVERS**
TOURNEVIS
`LOXXON`® **SQUARE DRIVE**



Heat treated alloy driver tip manufactured to precise specifications and assembled with an electro-plated steel blade. Ergonomically designed Butyrate handles for comfortable grip - colour coded for identification.

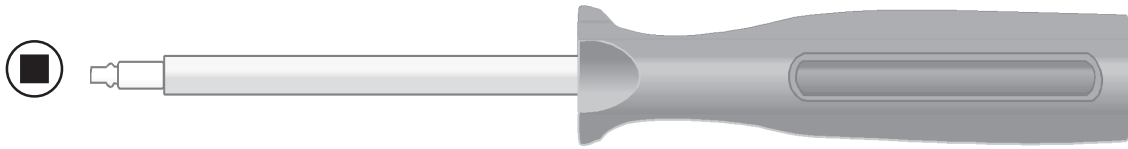

Order by Stock Number

Individually Packaged

| Bit Size | Handle Colour | STUBBY Stock No. | JUNIOR Stock No. | STANDARD Stock No. | LARGE Stock No. | X-LARGE Stock No. | Fits Screw Dia. |
|-----------------------|---------------|------------------|------------------|--------------------|-----------------|-------------------|-----------------|
| No. 0 | Yellow | — | 140-377 | — | — | — | No. 3 & 4 |
| No. 1 | Green | 140-373 | 140-378 | 140-383 | 140-388 | 140-393 | No. 5 to 7 |
| No. 2 | Red | 140-374 | 140-379 | 140-384 | 140-389 | 140-394 | No. 8 to 10 |
| No. 3 | Black | 140-375 | 140-380 | 140-385 | 140-390 | 140-395 | No. 12 & 14 |
| Overall Length | | 3-1/2" | 7-1/2" | 9" | 9-1/2" | 13" | |

For 6-Lobe Bull-Dog Screwdrivers and Bits see page 77.

222
Series

papco® **MAGNETIC NUTSETTERS**
INSTALLER MAGNETIQUE D'ECROU

"Papco" Nutsetters with a permanent high strength Alnico magnet are manufactured from high quality tool steel and heat treated for long life.



Order by Stock Number

1/4" Hex Shank

Individually Packaged

| Stock No. | Size x Overall Length | Socket Body Dia. | Stock No. | Size x Overall Length | Socket Body Dia. |
|-----------|-----------------------|--|-----------|-----------------------|------------------|
| 222-360 | 1/4 Hex x 1-7/8 | 7/16 | 222-370 | 1/4 Hex x 2-9/16 | 7/16 |
| 222-365 | 5/16 Hex x 1-7/8 | 1/2 | 222-375 | 5/16 Hex x 2-9/16 | 1/2 |
| 222-366 | 3/8 Hex x 1-7/8 | 9/16 | 222-376 | 3/8 Hex x 2-9/16 | 9/16 |
| 222-367 | 7/16 Hex x 1-7/8 | 5/8 | 222-377 | 7/16 Hex x 2-9/16 | 5/8 |
| 222-368 | 1/2 Hex x 1-7/8 | 11/16 | 222-378 | 1/2 Hex x 2-9/16 | 11/16 |
| 222-355 | 1/4 Hex x 3 | 7/16 Magnetic Bit Holder - 303 Stainless Steel | | | |

Available in Bulk - price on application.

8020
Series

papco® **ASSORTED NUTSETTER KITS**
JEUX D'INSTALLER D'ECROU

1 7/8" KIT No. 8020-905
Contains one each of 1/4, 5/16 and 3/8 Hex Magnetic Nutsetters in a clear tamper-proof pack.

2 9/16" KIT No. 8020-906
Contains one each of 1/4, 5/16 and 3/8 Hex Magnetic Nutsetters in an attractive transparent pack.

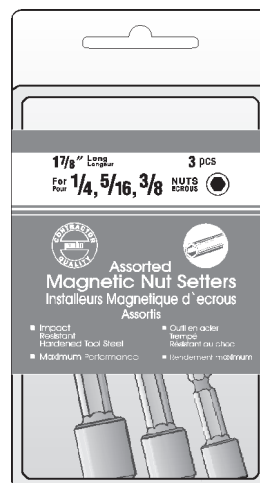



222 Series

papco 'SPEE-DRILL'® SCREWS
VIS 'SPEE-DRILL'®

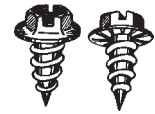

• THREAD FORMING • SELF DRILLING

'Papco' Spee-Drill Screws are driven with a standard electric drill. The special hardened conical point bores through sheet metal and the serrated washer face prevents thread stripping.

Standard Package 100 pieces
* Standard Package 1000 pieces

Order by Stock Number

| 100's Stock No. | *1000's Stock No. | Size Diameter x Length | 100's Stock No. | *1000's Stock No. | Size Diameter x Length |
|-----------------|-------------------|------------------------|-----------------|-------------------|------------------------|
| 222-085 | 222-585 | 6 x 3/8 | 222-189 | 222-689 | 10 x 1/2 |
| 222-111 | 222-611 | 7 x 1/2 | 222-191 | 222-691 | 10 x 3/4 |
| 222-137 | 222-637 | 8 x 1/2 | | | |

Note: All 'Papco' Spee-Drill Screws are Hex, Slotted, Washer Head with 1/4" across flats head size.

papco **6 in 1 MAGNETIC SCREWDRIVER SET**
JEU DE TOURNEVIS AIMANTE

No. 222-996

Uses 1/4" Hex Base Bits

Magnetized shaft holds bit and screw for easy use. Driver comes complete with six high quality bits - 1/4" Slotted, #1 and #2 Phillips, #1 and #2 Loxxon Square Socket and a T-15 6-Lobe. When not in use bits are stored in an impact-resistant, plastic handle. Shaft end can be used as a nut driver. Screw driver with 6 bits skin-packed on a handy point-of-purchase display card.



6-LOBE MAGNETIC SCREWDRIVER SET
JEU DE TOURNEVIS AIMANTE

No. 231-975

Same Magnetic Screwdriver as above. Driver comes complete with four high quality 6-Lobe bits - T-10, T-15, T-20 and T-25. Driver and bits skin packed on colourful self-selling display card.

'SPEE-DRILL' SCREW KIT
No. 020-617

Contains 1,000 'Papco' Spee-Drill Screws, 5 sizes and includes the 'Papco' Magnetic Chuck No. 222-360.

- All-metal box with hinged lid.
- Safety snap lock and carrying handle.
- Grease-resistant lid label with retail codes.



papco **MAGNETIC CHUCK**
MANDRIN MAGNETIQUE
No. 222-360

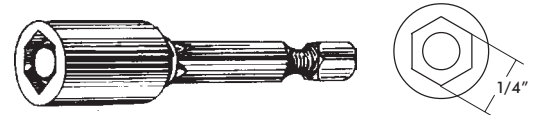

Individually Packaged

Fits all five sizes of 'Papco' Spee-Drill Screws. Fits standard electric drill. Has hexagon shank for positive drive. Permanent high-strength Alnico magnet. Made of heat treated tool steel for long life. Order by Stock Number 222-360

229 Series

papco **TRIM SCREWS**
VIS FINITION



BRIGHT CHROMIUM OR BLACK OXIDE PLATED



1 Black Oxide
ROUND PHILLIPS WASHERS HEAD

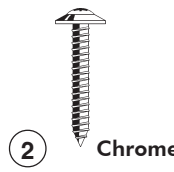

2 Chrome
OVAL PHILLIPS SEMS



3 Black Oxide



4 Chrome
ROUND PHILLIPS 'DRILL-X' SEMS



5 Black Oxide

Order by Stock Number

Standard Package Type 1=100 pieces, Types 2 to 5=50pcs.

| Stock No. | Diameter x Length | Hd. Type | Stock No. | Diameter x Length | Hd. Type | Stock No. | Diameter x Length | Hd. Type |
|-----------|-------------------|----------|-----------|-------------------|----------|-----------|-------------------|----------|
| 229-401 | 8 x 1/2 | 1 | 229-806 | 6 x 3/4 | 2 O.R. | 229-849 | 8 x 5/8 | 3 O.S. |
| 229-402 | 8 x 5/8 | 1 | 229-811 | 8 x 3/4 | 2 O.S. | 229-851 | 8 x 3/4 | 3 O.S. |
| 229-403 | 8 x 3/4 | 1 | 229-815 | 8 x 1 | 2 O.S. | 229-855 | 8 x 1 | 3 O.S. |
| 229-405 | 8 x 1 | 1 | 229-819 | 8 x 1-1/4 | 2 O.S. | 229-883 | 10 x 3/4 | 3 O.S. |
| 229-407 | 8 x 1-1/4 | 1 | 229-833 | 10 x 3/4 | 2 O.S. | 229-887 | 10 x 1 | 3 O.S. |
| 229-414 | 10 x 3/4 | 1 | 229-837 | 10 x 1 | 2 O.S. | 229-985 | 8 x 3/4 | 4 O.S. |
| 229-416 | 10 x 1 | 1 | | | | 229-986 | 8 x 1 | 4 O.S. |
| | | | | | | 229-987 | 8 x 3/4 | 5 O.S. |
| | | | | | | 229-988 | 8 x 1 | 5 O.S. |

For 'Papco' Trim Screws Master Assortments No. 020-661 and -662 see page 7.

229 Series

**papeco PHILLIPS TAPPING SCREWS
VIS TARAUEUSES PHILLIPS**

(SHEET METAL SCREWS)

RECESSED HEAD
Self-Tapping



BRIGHT PLATED
Hardened



OVAL
REGULAR



PAN
HEAD



Order by Stock Number

Standard Package 100 pieces

| Stock No. | Diameter x Length | Hd. Type | Stock No. | Diameter x Length | Hd. Type | Stock No. | Diameter x Length | Hd. Type |
|-----------|-------------------|----------|-----------|-------------------|----------|-----------|-------------------|----------|
| 229-010 | 6x1/2 | O.R. | 229-041 | 10x5/8 | O.R. | 229-124 | 8x1 | P.H. |
| 229-012 | 6x3/4 | O.R. | 229-044 | 10x1 | O.R. | 229-140 | 10x1/2 | P.H. |
| 229-014 | 6x1 | O.R. | 229-108 | 6x3/8 | P.H. | 229-142 | 10x3/4 | P.H. |
| 229-016 | 6x1-1/4 | O.R. | 229-110 | 6x1/2 | P.H. | 229-144 | 10x1 | P.H. |
| 229-022 | 8x3/4 | O.R. | 229-119 | 8x3/8 | P.H. | 229-160 | 12x1/2 | P.H. |
| 229-024 | 8x1 | O.R. | 229-120 | 8x1/2 | P.H. | 229-164 | 12x1 | P.H. |
| 229-026 | 8x1-1/4 | O.R. | 229-122 | 8x3/4 | P.H. | | | |

O.R. - OVAL REGULAR

P.H. - PAN HEAD



OVAL HEAD

**papeco TRIM SCREWS
VIS FINITION**



These Oval and Pan Phillips Head Screws are used in all interior and exterior trim applications on cars and trucks.



PAN HEAD

ZINC OR BLACK OXIDE PLATED

Order by Stock Number

Standard Package 100 pieces

| Stock No. | Diameter x Length | Hd. Type | Stock No. | Diameter x Length | Hd. Type | Stock No. | Diameter x Length | Hd. Type |
|-----------|-------------------|----------|-----------|-------------------|----------|-----------|-------------------|----------|
| 229-219 | 8 x 3/8 Zinc | O.S. | 229-242 | 10 x 3/4 Zinc | O.S. | 229-923 | 8 x 1-1/2 Black | O.S. |
| 229-220 | 8 x 1/2 Zinc | O.S. | 229-244 | 10 x 1 Zinc | O.S. | 229-933 | 10 x 3/4 Black | O.S. |
| 229-222 | 8 x 3/4 Zinc | O.S. | 229-248 | 10 x 1-1/2 Zinc | O.S. | 229-937 | 10 x 1 Black | O.S. |
| 229-224 | 8 x 1 Zinc | O.S. | 229-250 | 10 x 2 Zinc | O.S. | 229-945 | 10 x 1-1/2 Black | O.S. |
| 229-225 | 8 x 1-1/8 Zinc | O.S. | 229-252 | 10 x 2-1/2 Zinc | O.S. | 229-960 | 6 x 1/2 Black | P.H. |
| 229-226 | 8 x 1-1/4 Zinc | O.S. | 229-911 | 8 x 3/4 Black | O.S. | 229-962 | 8 x 1/2 Black | P.H. |
| 229-227 | 8 x 1-3/8 Zinc | O.S. | 229-912 | 8 x 3/4 Black | O.R. | 229-968 | 8 x 3/4 Black | P.H. |
| 229-228 | 8 x 1-1/2 Zinc | O.S. | 229-915 | 8 x 1 Black | O.S. | 229-972 | 8 x 1 Black | P.H. |
| 229-229 | 8 x 1-3/4 Zinc | O.S. | 229-916 | 8 x 1 Black | O.R. | 229-980 | 10 x 3/4 Black | P.H. |
| 229-240 | 10 x 1/2 Zinc | O.S. | 229-919 | 8 x 1-1/4 Black | O.S. | 229-982 | 10 x 1 Black | P.H. |
| 229-241 | 10 x 5/8 Zinc | O.S. | | | | | | |

O.S. - OVAL SMALL HEAD

O.R. - OVAL REGULAR HEAD

P.H. - PAN HEAD

**TRIM SCREW
GARAGE ASSORTMENT
No. 020-023**

Contains 100 Phillips Head Self-Tapping Sheet Metal Screws in nine popular sizes - in Oval Regular and Oval Small types. Packed in a rigid, clear plastic box with hinged lid.



**TRIM SCREW
GARAGE ASSORTMENT
No. 020-027**

Contains 100 Metric Zinc Plated Trim Screws in Pan Oval and Round Washer heads. Six sizes in a clear plastic box. (See next page.)



**TRIM SCREW
MASTER ASSORTMENT No. 020-613**

- A well-balanced assortment of Tapping Screws for Trim, Body and Fender work.
- Contains 530 Screws. 25 sizes PHILLIPS HEAD - Self-Tapping Sheet Metal Screws.
- Safety snap carrying handle.
- Metal box with handy moulded compartments.
- Actual size illustrated lid label with retail codes.
- Refills available in standard packages of 100.

Size: 9-3/4" w. x 13-3/4" l. x 2" d.

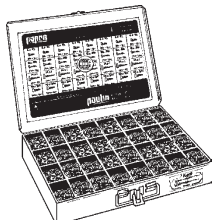

papeco SUPER SERVICE ASSORTMENT No. 020-809

Contains 1225 Phillips Trim Tapping Screws - 30 items
Large size, rigid metal box with high-strength plastic compartments.
For more details see page 9. Large size: 12" w. x 18" l. x 3" d.



230
Series



METRIC TRIM SCREWS VIS FINITION METRIQUE

**‘POZI-DRIV’ TAPPING SCREWS
BRIGHT CHROMIUM PLATED***

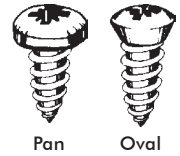

Order by Stock Number

Standard Package 100 pieces

| PAN HEAD | | | OVAL SMALL HEAD | | |
|-----------|---------------|-------------|-----------------|---------------|-------------|
| Stock No. | Dia. x Length | Factory No. | Stock No. | Dia. x Length | Factory No. |
| 230-203 | 4.2 x 13mm | 11503482 | 230-207 | 4.2 x 20mm | 11502471 |
| 230-205 | 4.2 x 20mm | 11501929 | | | |
| 230-206* | 4.2 x 20mm | 11500406 | | | |

*18.8 Stainless Steel Bright Chromium Plated

Note: 4.2mm=No. 8 diameter (.164")

230
Series



METRIC MOULDING TRIM SCREWS VIS FINITION MOULDRE METRIQUE

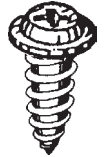

**ROUND LARGE CROWNED WASHER HEAD
‘POZI-DRIV’ TAPPING SCREWS**

Used in body work for attaching the chrome moulding in the wheel well and floor stripping of late model cars and trucks.

BRIGHT CHROMIUM PLATED

Order by Stock Number

Standard Package 100 pieces

| Stock No. | Dia. x Length | Factory No. | Stock No. | Dia. x Length | Factory No. |
|-----------|------------------|-------------|-----------|------------------|-------------|
| 230-301 | 4.2 x 8mm | 11503266 | 230-304 | 4.2 x 16mm | 11503635 |
| 230-302 | 4.2 x 12mm | 11501794 | 230-305 | 4.2 x 20mm | - |
| 230-303 | 4.2 x 12mm Black | 11501896 | 230-306 | 4.2 x 20mm Black | 11501884 |

Note: 4.2mm=No. 8 diameter (.164")

225
Series



TRUCK AND TRAILER FASTENERS ATTACHE DE CAMION ET REMORQUE

PLYWOOD LINING SCREWS

Used to fasten plywood liners to body studs and frames.

Order by Stock Number

Standard Package 100 pieces

Stock No. 225-182 #18 x 2"

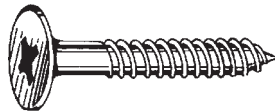

Special Flush Head - Phillips - Wood Screw
Bright Plated Steel

Stock No. 225-186 #10 x 1-1/4"



Special Flush Head - Phillips - Type A
Bright Plated Steel Hardened Tapping Screws

Stock No. 225-183 #10 x 3/4"

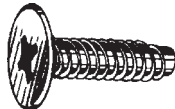

Special Flush Head - Phillips - Thread Forming - Type B
Bright Plated Steel Hardened Tapping Screws
Drill 3/32" pilot hole.

Stock No. 225-188 #14 x 2-1/2"



Flat Socket Head - Wood Screw
Bright Plated Steel

Stock No. 225-184 #14 x 3"

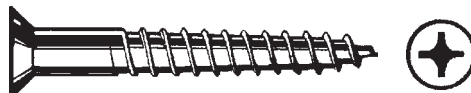

Flat Head - Phillips - Wood Screw
Bright Plated Steel

papeo ALUMINUM PANEL RIVETS



Stock No.
225-196



Stock No.
225-197

Made from heat treated aluminum.
225-196 3/16 x 7/16 Full Brazier Head.
225-197 1/4 x 7/16 Mod. Brazier Head.
Used to fasten aluminum panels.

PAPCO THREAD CUTTING FLOORBOARD SCREWS



225 Series



Phillips Drive

Flat Head Type "F"
BRIGHT ZINC PLATED

Used to fasten wood plank, laminated plywood or corrugated aluminum flooring to the supporting steel cross members of trucks and trailers.



Square Drive

Order by Stock Number

Standard Package 100 Pcs.

| Stock No. | Size | Driver | Stock No. | Size | Driver |
|-----------|----------------|----------------|-----------|----------------|--------------|
| 225-792 | 1/4-20 x 1-1/2 | No. 3 Phillips | 225-752 | 1/4-20 x 1-1/2 | No. 3 Square |
| 225-793 | 1/4-20 x 2" | No. 3 Phillips | 225-753 | 1/4-20 x 2" | No. 3 Square |
| 225-794 | 1/4-20 x 2-1/2 | No. 3 Phillips | 225-754 | 1/4-20 x 2-1/2 | No. 3 Square |
| 225-795 | 1/4-20 x 3" | No. 3 Phillips | 225-755 | 1/4-20 x 3" | No. 3 Square |

PAPCO 6-LOBE FLOORBOARD SCREWS



6-Lobe Flat Head Type "F"
- Phosphate and Oil Finish

Order by Stock Number

Standard Package 50 Pcs.

| Stock No. | Size | Driver | Stock No. | Size | Driver |
|-----------|----------------|--------|-----------|-----------------|--------|
| 225-890 | 1/4-20 x 1" | T-30 | 225-895 | 1/4-20 X 3" | T-30 |
| 225-891 | 1/4-20 x 1-1/4 | T-30 | 225-896 | 5/16-18 X 1-3/4 | T-40 |
| 225-892 | 1/4-20 x 1-1/2 | T-30 | 225-897 | 5/16-18 X 2" | T-40 |
| 225-893 | 1/4-20 x 2" | T-30 | 225-898 | 5/16-18 X 2-1/2 | T-40 |
| 225-894 | 1/4-20 x 2-1/2 | T-30 | | | |

PAPCO 'DRILL-X' SELF-DRILLING TAPPING SCREWS

VIS TARAUD FORET DRILL-X®

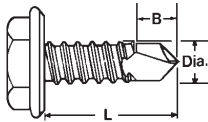

BRIGHT PLATED

232 Series

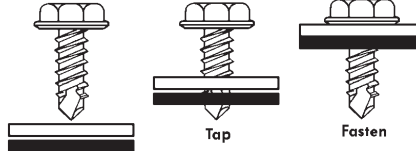

Drill Point length determines maximum metal thickness drillable.
#2 Point up to .110 Thick #3 Point up to .250 Thick

'Papco' Self-Drilling and Tapping Screws are made of high-quality steel and are specially heat treated. The drill point has been incorporated into the screw in the familiar twist drill design. These screws drill their own hole - form mating threads - fasten securely and can be used in steel, plastics, composite materials, wood plus various laminates. Determine total thickness of the material to be drilled then choose No. 2 or No. 3 point to allow complete drilling. Available in Pan Phillips, Pan Socket and Hex Head.

Order by Stock Number

Standard Package 100 Screws

| Stock No. | Dia. x (L) | Drill Point | Max-Metal Drillable (B) | Driver | Stock No. | Dia. x (L) | Drill Point | Max-Metal Drillable (B) | Driver |
|--------------------------|------------|-------------|-------------------------|--------|-----------|------------|-------------|-------------------------|--------|
| PAN PHILLIPS HEAD | | | | | | | | | |
| 232-010 | 6 x 3/8 | #2 | .090" | #2 | 232-020 | 10 x 1/2 | #2 | .110" | #2 |
| 232-011 | 6 x 1/2 | #2 | .090" | #2 | 232-022 | 10 x 3/4 | #2 | .110" | #2 |
| 232-013 | 8 x 1/2 | #2 | .100" | #2 | 232-024 | 10 x 1 | #2 | .110" | #2 |
| 232-015 | 8 x 3/4 | #2 | .100" | #2 | | | | | |
| PAN SOCKET HEAD | | | | | | | | | |
| 232-031 | 6 x 1/2 | #2 | .090" | #2 | 232-035 | 8 x 1 | #2 | .100" | #2 |
| 232-032 | 8 x 1/2 | #2 | .100" | #2 | 232-038 | 10 x 5/8 | #2 | .175" | #2 |
| 232-034 | 8 x 3/4 | #2 | .100" | #2 | 232-039 | 10 x 3/4 | #2 | .175" | #2 |
| HEX WASHER HEAD | | | | | | | | | |
| 232-071 | 8 x 1/2 | #2 | .100" | 1/4 | 232-086 | 12 x 3/4 | #3 | .210" | 5/16 |
| 232-073 | 8 x 3/4 | #2 | .100" | 1/4 | 232-088 | 12 x 1-1/2 | #3 | .210" | 5/16 |
| 232-074 | 8 x 1 | #2 | .100" | 1/4 | 232-089 | 12 x 2 | #3 | .210" | 5/16 |
| 232-078 | 10 x 1/2 | #2 | .110" | 5/16 | 232-092 | 14 x 3/4 | #3 | .250" | 3/8 |
| 232-080 | 10 x 3/4 | #2 | .110" | 5/16 | 232-093 | 14 x 1 | #3 | .250" | 3/8 |
| 232-082 | 10 x 1 | #3 | .175" | 5/16 | 232-095 | 14 x 1-1/2 | #3 | .250" | 3/8 |
| 232-084 | 10 x 1-1/2 | #3 | .175" | 5/16 | 232-097 | 14 x 2 | #3 | .250" | 3/8 |

'DRILL-X' MASTER ASSORTMENT No. 020-668

Contains 20 sizes (complete coverage) of 'Papco' Drill-X Self-Drilling Tapping Screws in Pan Socket and Hexagon Washer Head. Packed in a metal box with high-strength plastic compartments. Grease-resistant lid label shows actual size illustrations, measuring chart and retail price codes.





231 Series



**6-LOBE TRIM SCREWS
VIS FINITION 6-LOBE**

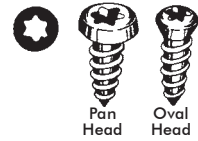

METRIC STAINLESS STEEL TAPPING SCREWS

Used on automotive trim, headlight and tail-light bezels and many other vehicle and appliance applications. The six-lobed drive system improves driver tool life, stops cam-out and increases mechanic's efficiency. These stainless steel screws have Bright Chromium or Black Oxide finish to conform to original specifications.

Order by Stock Number

Standard Package 25 pieces

| OVAL TRIM HEAD | | | | | PAN HEAD | | | | |
|----------------|------------|--------|--------|------------|-----------|------------|--------|--------|------------|
| Stock No. | Size | Finish | Driver | O.E.M. No. | Stock No. | Size | Finish | Driver | O.E.M. No. |
| 231-205 | 4.2 x 20mm | Chrome | T-15 | 11504069 | 231-251 | 4.2 x 20mm | Chrome | T-15 | 11504647 |
| 231-206 | 4.2 x 20mm | Black | T-15 | 11504659 | 231-252 | 4.2 x 20mm | Black | T-15 | 11504655 |
| 231-209 | 4.2 x 30mm | Chrome | T-15 | 11504522 | 231-257 | 4.2 x 35mm | Chrome | T-15 | 11504663 |
| 231-210 | 4.2 x 30mm | Black | T-15 | 11504656 | 231-264 | 4.2 x 50mm | Black | T-15 | 11504774 |
| 231-213 | 4.2 x 40mm | Chrome | T-15 | 11504654 | | | | | |
| 231-219 | 4.2 x 55mm | Chrome | T-15 | 11504664 | | | | | |

Note: 4.2mm = No. 8 diameter (.164")

**GARAGE ASSORTMENT
No. 020-070**

Contains 70 6-Lobe Oval Head Trim Screws - 6 popular sizes in a clear styrene box.



**GARAGE ASSORTMENT
No. 020-071**

Contains 70 6-Lobe Pan Head Trim Screws - 4 popular sizes in a clear styrene box.

**MASTER ASSORTMENT
No. 020-669**

This assortment contains 240 6-Lobe Trim Screws in both Oval and Pan Heads - 10 popular sizes packed in a sturdy, metal container with handy moulded compartments, an actual size illustrated, grease-resistant lid label - plus a "Papco" T-15 Bull-Dog 6-Lobe driver.



Size: 9-3/4" w. x 13-3/4" l. x 2" d.



**UTILITY ASSORTMENT
No. 020-355**

This handy assortment contains 140 6-Lobe Trim Screws in both Oval and Pan Heads - 10 popular sizes packed in a sturdy fibre-board container complete with actual size illustrated, grease-resistant lid label.

231 Series



**6-LOBE BULL-DOG DRIVERS
TOURNEVIS 6-LOBE**

Specially designed to be used with 6-Lobe screws, these drivers feature a 1-3/16" diameter heavy-duty, Bull-Dog handle. These professional quality tools permit greater torque and offer a more comfortable grip than regular drivers.

8-1/2" Overall Length - 4-1/2" Handle Length.

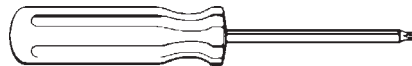

Order by Stock Number

Individually Carded

| Stock No. | Stock No. | Stock No. | Stock No. | Stock No. | Stock No. | Stock No. | Stock No. |
|-----------|-----------|-----------|-----------|-----------|-----------|-----------|-----------|
| 231-980 | 231-981 | 231-982 | 231-983 | 231-984 | 231-985 | 231-986 | |
| | | | | | | | |
| T-8 | T-10 | T-15 | T-20 | T-25 | T-27 | T-30 | T-40 |
| | | 231-992 | 231-993 | 231-994 | | 231-996 | 231-998 |

For 6 in 1 6-LOBE Magnetic Screwdriver see page 73.

3000
Series

papeo

TAPCON® CONCRETE SCREWS
VIS A BETON `TAPCON®`



- NO PLUGS
- JUST DRILL AND DRIVE

Ideal for concrete, brick or hollow block. Shear strength: 3/16" dia. = 145lbs, 1/4" dia. = 285lbs. Using the correct Tapcon Bit, drill hole in masonry to depth of at least 1/4" deeper than installed screw.

NOTE: DO NOT USE BIT TO DRILL STEEL FIXTURES. Position Tapcon through fixture and drive into pre-drilled hole until seated. The Condrive Installation Tool is available for repetitive installations.

Genuine Blue Zinc Dichromate Plated

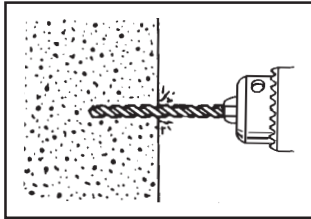
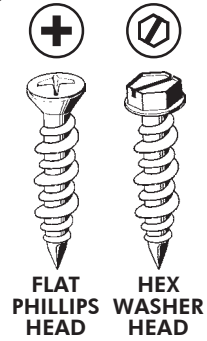

DRILL

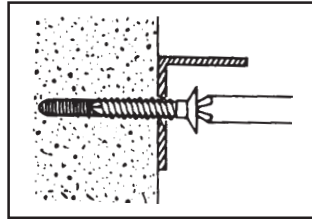

DRIVE

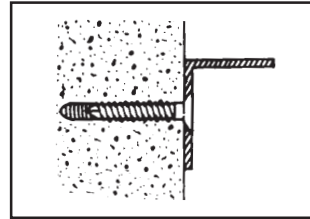

INSTALLED

Order by Stock Number

Standard Package 100 Screws (Includes Tapcon Drill Bit)

| 3/16 Diameter | | | | 1/4 Diameter | | | |
|--------------------|---------------|--------------|-------------------|--------------------|---------------|-------------|-------------------|
| Phillips Stock No. | Hex Stock No. | Size | Tapcon Drill Size | Phillips Stock No. | Hex Stock No. | Size | Tapcon Drill Size |
| 3110 | 3010 | 3/16 x 1-1/4 | 5/32 x 3-1/2 | 3310 | 3210 | 1/4 x 1-1/4 | 3/16 x 3-1/2 |
| 3120 | 3020 | 3/16 x 1-3/4 | 5/32 x 3-1/2 | 3320 | 3220 | 1/4 x 1-3/4 | 3/16 x 3-1/2 |
| 3130 | 3030 | 3/16 x 2-1/4 | 5/32 x 4-1/2 | 3330 | 3230 | 1/4 x 2-1/4 | 3/16 x 4-1/2 |
| 3140 | 3040 | 3/16 x 2-3/4 | 5/32 x 4-1/2 | 3340 | 3240 | 1/4 x 2-3/4 | 3/16 x 4-1/2 |
| 3160 | 3060 | 3/16 x 3-1/4 | 5/32 x 5-1/2 | 3350 | 3250 | 1/4 x 3-1/4 | 3/16 x 5-1/2 |
| | | | | 3370 | 3270 | 1/4 x 4 | 3/16 x 5-1/2 |

Tapcon® is a registered Trademark of ITW Buildex

papeo CONDRIVE INSTALLATION TOOL OUTIL `CONDRIVE` D`INSTALLER No. 7000

For repetitive installation of `Tapcon` Concrete Screws

The Condrive 7000 is a multi-purpose installation tool that is inserted into a 3/8 or 1/2 inch chuck of a standard hammer or electric drill. The Condrive 7000 Tool can be set up to drive either Hex or Phillips drive Tapcon Screws.

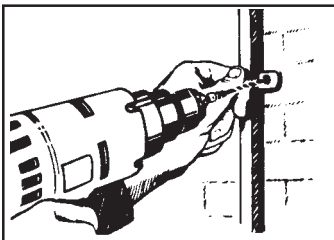

1. Insert drill adapter with drill bit into chuck of electric drill. Drill hole into masonry 1/4" deeper than installed screw.

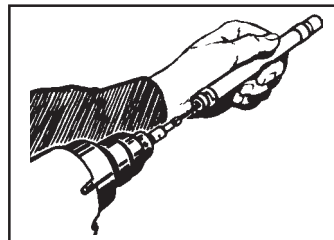

2. Place Hex or Phillips driver bit into tool. Slide end of tool sleeve over drill bit and snap onto drill adaptor.

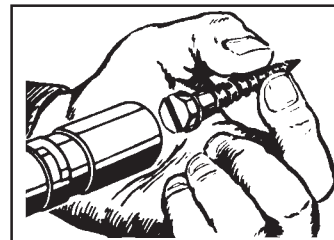

3. Insert head of Tapcon Concrete Screw into Hex or Phillips driver bit. Install screw through fixture into pre-drilled hole until seated.



3400
Series

papco

'DYNABOLT®' SLEEVE ANCHORS
ANCRES A DOUILLE 'DYNABOLT®'

- ZINC PLATED CARBON STEEL • MEDIUM DUTY CONCRETE OR MASONRY ANCHORS

'Papco' Sleeve Anchors can be used in cement block, thin wall or solid concrete, brick or stone. Ideal for anchoring partitions, cabinets, shelves, fire extinguishers, duct work, electrical systems, heating units etc. Drill hole same size as diameter of anchor to any depth exceeding minimum embedment. Clean hole of dust after drilling. Insert anchor through fixture and tighten nut with wrench 2-3 turns. Length is measured from washer to end of anchor.

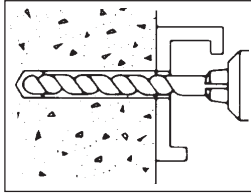
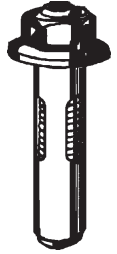

DRILL

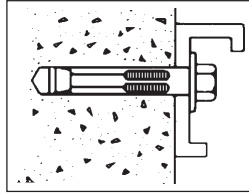

INSTALL

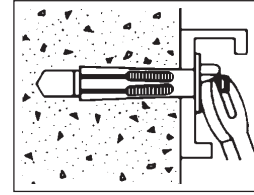

TIGHTEN

Order by Stock Number

For Masonry Drill Bits see page 176.

| Stock No. | Dia. x Length | Min. Embed. | Max. Mat. Thick. | Std. Pkg. | Ultimate Load Capacity* | | Use Drill Bit No. |
|-----------|---------------|-------------|------------------|-----------|-------------------------|------------|-------------------|
| | | | | | LOAD lbs. | SHEAR lbs. | |
| 3400 | 1/4 x 1-3/8 | 1-1/8 | 1/4 | 100 | 1613 | 1751 | 997-587 |
| 3405 | 1/4 x 2-1/4 | 1-1/8 | 1-1/8 | 20 | 1613 | 1751 | 997-587 |
| 3410 | 5/16 x 1-1/2 | 1-1/4 | 1/4 | 100 | 2429 | 2487 | 997-588 |
| 3415 | 5/16 x 2-1/2 | 1-1/4 | 1-1/4 | 20 | 2429 | 2487 | 997-588 |
| 3420 | 3/8 x 1-7/8 | 1-1/2 | 3/8 | 50 | 2597 | 2872 | 997-589 |
| 3425 | 3/8 x 3 | 1-1/2 | 1-1/2 | 25 | 2597 | 2872 | 997-589 |
| 3430 | 1/2 x 2-1/4 | 1-7/8 | 3/8 | 10 | 5385 | 5582 | 997-590 |
| 3435 | 1/2 x 3 | 1-7/8 | 1-1/8 | 10 | 5385 | 5582 | 997-590 |
| 3440 | 1/2 x 4 | 1-7/8 | 2-1/8 | 10 | 5385 | 5582 | 997-590 |

* Ultimate load capacity in 4000 p.s.i. 3/4 inch crushed limestone aggregate concrete for depth of embedment indicated. Safe working loads should not exceed 25% of ultimate load capacity for single installations under static loading.

5000
Series

papco

'TRUBOLT®' WEDGE ANCHORS
ANCRES DE CALAGE 'TRUBOLT®'

- ZINC PLATED CARBON STEEL • HEAVY-DUTY CONCRETE ANCHORS

'Papco' Heavy-duty Wedge Anchors are ideal for anchoring electrical, heating, ventilating, plumbing and air conditioning systems - storage racks, machinery mounting, highway rails, guards and posts in concrete. Each anchor is assembled with a stainless steel expansion clip providing high corrosion resistance and is fully threaded for varying material thicknesses. Drill hole same size as diameter of anchor to any depth exceeding concrete embedment. Clean hole of dust after drilling. Insert anchor through fixture and tighten nut 3-5 turns. Length is measured from washer to end of anchor.

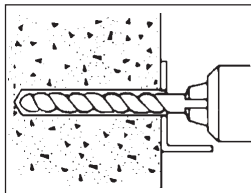
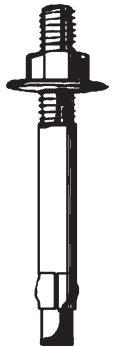

DRILL

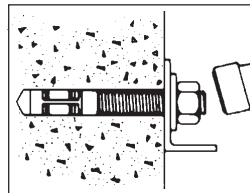

INSTALL

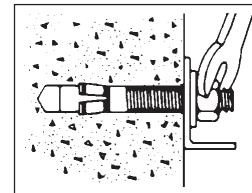

TIGHTEN

Order by Stock Number

| Stock No. | Dia. x Length | Concrete Embed. | Max. Mat. Thick. | Std. Pkg. | Ultimate Load Capacity* | | Use Drill Bit No. |
|-----------|---------------|-----------------|------------------|-----------|-------------------------|------------|-------------------|
| | | | | | LOAD lbs. | SHEAR lbs. | |
| 5005 | 1/4 x 2-1/4 | 1-15/16 | 7/8 | 25 | 2999 | 1910 | 997-587 |
| 5015 | 3/8 x 2-1/4 | 1-1/2 | 3/8 | 50 | 3219 | 4029 | 997-589 |
| 5020 | 3/8 x 2-3/4 | 1-1/2 | 7/8 | 40 | 3219 | 4029 | 997-589 |
| 5025 | 3/8 x 3 | 3 | 1-1/8 | 30 | 5678 | 4305 | 997-589 |
| 5030 | 3/8 x 3-3/4 | 4-1/2 | 1-7/8 | 25 | 5935 | 4581 | 997-589 |
| 5055 | 1/2 x 3-3/4 | 2-1/4 | 1-1/8 | 15 | 5384 | 6900 | 997-590 |
| 5060 | 1/2 x 4-1/4 | 4-1/8 | 1-1/2 | 10 | 7333 | 7449 | 997-590 |
| 5065 | 1/2 x 5-1/2 | 6 | 2-3/4 | 10 | 9003 | 7998 | 997-590 |

* Ultimate load capacity in 4000 p.s.i. stone aggregate for the depth of embedment indicated. Safe working loads should not exceed 25% of ultimate load capacity for single installations under static loading. 'Dynabolt' and 'Trubolt' are registered trademarks of ITW Buildex.

239
Series

papeco BLIND RIVETS RIVETS OBTURATEURS



Fasten joints without access to reverse side. Insert rivets - the retracting jaws in the setting tool pull the mandrel head into the rivet body on the reverse side until the mandrel breaks. The high clinch action pulls the parts together for a tight, vibration-proof fastening.

Standard Packages: 1/8" and 5/32" dia. 500 rivets; 3/16" dia. 250 rivets; Stainless Steel 100 rivets. Most popular sizes available in 50 Rivets per convenient hang-up boxes.
*25 per hang-up box.

HOW TO MEASURE RIVETS

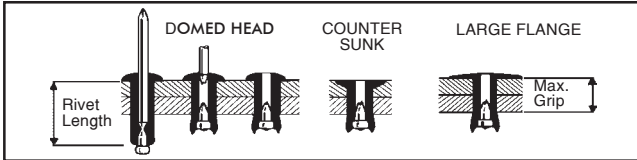
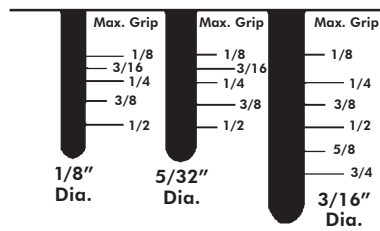

| Rivet Diameter | | Drill | |
|----------------|--------|--------|-------------|
| Inch | Metric | Number | Size |
| 3/32 | 2.4mm | #41 | .096 - .100 |
| 1/8 | 3.2mm | #30 | .129 - .133 |
| 5/32 | 4.0mm | #20 | .160 - .164 |
| 3/16 | 4.8mm | #11 | .192 - .196 |

Rivet Length measure to end of rivet body.
Recommended Hole Sizes

Order by Stock Number

| Stock No. | Other No. | Hang-up Box No. | Rivet Dia. | Grip Range | Head Type | Rivet Length | |
|--|-----------|-----------------|-------------|-------------|------------|--------------|------|
| ALUMINUM RIVET - ALUMINUM MANDREL | | | | | | | |
| 239-011 | AA42D | 239-611 | 1/8 (.125) | 1/16 - 1/8 | Domed | .232 | |
| 239-014 | AA43D | 239-614 | | 1/8 - 3/16 | Domed | .294 | |
| 239-017 | AA44D | 239-617 | | 3/16 - 1/4 | Domed | .357 | |
| 239-018 | AA44LF | - | | 3/16 - 1/4 | L. Flange | .357 | |
| 239-023 | AA46D | - | | 5/16 - 3/8 | Domed | .481 | |
| 239-026 | AA48D | - | | 3/8 - 1/2 | Domed | .625 | |
| 239-038 | AA56D | - | 5/32 (.156) | 1/4 - 3/8 | Domed | .504 | |
| 239-047 | AA62D | *239-647 | | 3/16 (.188) | 1/16 - 1/8 | Domed | .277 |
| 239-053 | AA64D | *239-653 | | | 1/8 - 1/4 | Domed | .402 |
| 239-056 | AA66D | - | | 1/4 - 3/8 | Domed | .527 | |
| 239-057 | AA66LF | - | | 1/4 - 3/8 | L. Flange | .527 | |
| 239-059 | AA68D | - | | 3/8 - 1/2 | Domed | .652 | |
| 239-060 | AA68LF | - | 3/8 - 1/2 | L. Flange | .652 | | |
| ALUMINUM RIVET - STEEL MANDREL | | | | | | | |
| 239-111 | AS42D | 239-711 | 1/8 (.125) | 1/16 - 1/8 | Domed | .232 | |
| 239-114 | AS43D | 239-714 | | 1/8 - 3/16 | Domed | .294 | |
| 239-117 | AS44D | 239-717 | | 3/16 - 1/4 | Domed | .357 | |
| 239-150 | AS62D | *239-750 | 3/16 (.188) | 1/16 - 1/8 | Domed | .277 | |
| 239-153 | AS64D | *239-753 | | 1/8 - 1/4 | Domed | .402 | |
| 239-156 | AS66D | - | | 1/4 - 3/8 | Domed | .527 | |
| 239-159 | AS68D | - | | 3/8 - 1/2 | Domed | .652 | |
| 239-160 | AS68LF | - | | 3/8 - 1/2 | L. Flange | .652 | |
| STEEL RIVET - STEEL MANDREL | | | | | | | |
| 239-210 | SS42C | 239-810 | 1/8 (.125) | 1/16 - 1/8 | Csk. | .276 | |
| 239-211 | SS42D | 239-811 | | 1/16 - 1/8 | Domed | .232 | |
| 239-213 | SS43C | 239-813 | | 1/8 - 3/16 | Csk. | .316 | |
| 239-214 | SS43D | 239-814 | | 1/8 - 3/16 | Domed | .294 | |
| 239-216 | SS44C | 239-816 | | 3/16 - 1/4 | Csk. | .362 | |
| 239-217 | SS44D | 239-817 | | 3/16 - 1/4 | Domed | .357 | |
| 239-218 | SS44LF | - | 3/16 - 1/4 | L. Flange | .357 | | |
| 239-223 | SS46D | - | 5/32 (.156) | 5/16 - 3/8 | Domed | .481 | |
| 239-226 | SS48D | - | | 3/8 - 1/2 | Domed | .625 | |
| 239-229 | SS52D | - | | 1/16 - 1/8 | Domed | .254 | |
| 239-235 | SS54D | - | | | 3/16 - 1/4 | Domed | .397 |
| 239-238 | SS56D | - | | 1/4 - 3/8 | Domed | .504 | |
| 239-250 | SS62D | *239-850 | | 3/16 (.188) | 1/16 - 1/8 | Domed | .277 |
| 239-253 | SS64D | *239-853 | 1/8 - 1/4 | | Domed | .402 | |
| 239-256 | SS66D | - | 1/4 - 3/8 | | Domed | .527 | |
| 239-257 | SS66LF | - | 1/4 - 3/8 | | L. Flange | .527 | |
| 239-259 | SS68D | - | 3/8 - 1/2 | | Domed | .652 | |
| 239-260 | SS68LF | - | 3/8 - 1/2 | | L. Flange | .652 | |
| 239-262 | SS610D | - | 1/2 - 5/8 | | Domed | .777 | |
| 239-263 | SS610LF | - | 1/2 - 5/8 | | L. Flange | .777 | |
| 239-265 | SS612D | - | 5/8 - 3/4 | | Domed | .902 | |
| 239-266 | SS612LF | - | 5/8 - 3/4 | | L. Flange | .902 | |
| STAINLESS RIVET - STEEL MANDREL | | | | | | | |
| 5195-111 | STS42D | - | 1/8 (.125) | 1/16 - 1/8 | Domed | .232 | |
| 5195-114 | STS43D | - | | 1/8 - 3/16 | Domed | .294 | |
| 5195-117 | STS44D | - | | 3/16 - 1/4 | Domed | .357 | |
| 5195-123 | STS46D | - | | 5/16 - 3/8 | Domed | .481 | |
| 5195-126 | STS48D | - | | 3/8 - 1/2 | Domed | .625 | |
| 5195-150 | STS62D | - | | 3/16 (.188) | 1/16 - 1/8 | Domed | .277 |
| 5195-153 | STS64D | - | 1/8 - 1/4 | | Domed | .402 | |
| 5195-156 | STS66D | - | 1/4 - 3/8 | | Domed | .527 | |
| 5195-159 | STS68D | - | 3/8 - 1/2 | | Domed | .652 | |
| STAINLESS RIVET - STAINLESS MANDREL | | | | | | | |
| 5195-211 | STST42D | - | 1/8 (.125) | | 1/16 - 1/8 | Domed | .232 |
| 5195-214 | STST43D | - | | 1/8 - 3/16 | Domed | .294 | |
| 5195-217 | STST44D | - | | 3/16 - 1/4 | Domed | .357 | |
| 5195-223 | STST46D | - | | 5/16 - 3/8 | Domed | .481 | |
| 5195-226 | STST48D | - | | 3/8 - 1/2 | Domed | .625 | |
| 5195-250 | STST62D | - | | 3/16 (.188) | 1/16 - 1/8 | Domed | .277 |
| 5195-253 | STST64D | - | 1/8 - 1/4 | | Domed | .402 | |
| 5195-256 | STST66D | - | 1/4 - 3/8 | | Domed | .527 | |
| 5195-259 | STST68D | - | 3/8 - 1/2 | | Domed | .652 | |



239
Series

papco® HAND RIVETERS RIVETEUSE MANUELLE

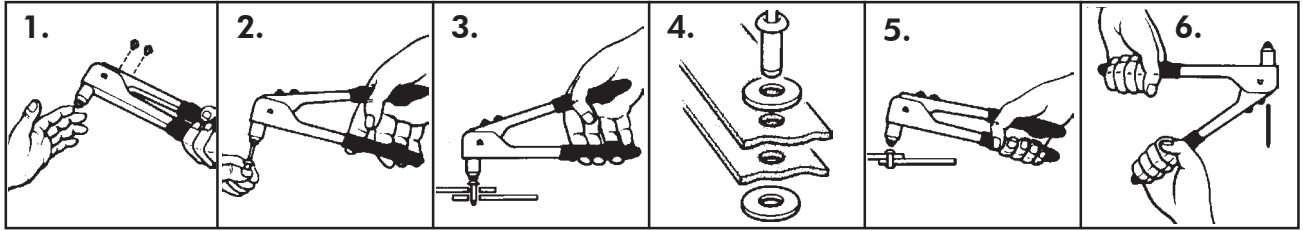

1. Drill a hole of the recommended size in each of the parts to be riveted and select correct nose-piece.

2. Fully open handles. Insert rivet until head touches nose-piece.

3. Insert rivet in the hole.

4. For soft materials or oversize holes use back-up plates to eliminate rivet pull-through.

5. Squeeze handles together. If mandrel does not break, open handles, push rivet head back to nose-piece and repeat until mandrel breaks.

6. Hold riveter with nose-piece up. Fully open handles and snapped off stem will fall out.

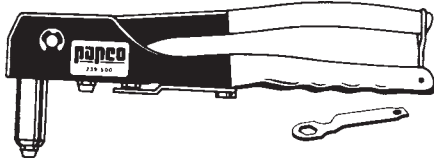

No. 239-500 MEDIUM DUTY BLIND RIVETER

An economical tool for medium duty. Vinyl grips on stamped long handles for extra leverage with milled steel nose. Sets 3/32", 1/8", 5/32" and 3/16" dia. aluminum rivets.

Individually packaged.

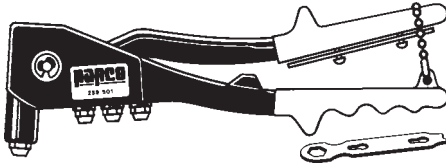

No. 239-501 PROFESSIONAL SERVICE BLIND RIVETER

Sturdy, fast acting tool. Will set 3/32", 1/8", 5/32" and 3/16" dia. rivets. Capacity 3/16" aluminum. Moulded contour hand grips and long forged handles for extra leverage. Complete with four nose-pieces.

Heavy Duty

Individually packaged.



No. 400-002 CERAMIC BLOCK MAGNETS

'Papco' High Strength Ceramic Block Magnets are ideal for temporary attachment of metal panels, work orders or masking material without damaging painted areas or other metal surfaces. Each skin-packed card contains two block magnets. Each magnet is 7/8" wide x 1-7/8" long x 3/8" thick.

For other Magnet products see page 148.



BLIND RIVET MASTER ASSORTMENT No. 020-667

Contains 1200 pieces - 10 popular sizes of Aluminum and Steel Domed Head Rivets and 3 sizes of Back-up Plates. Packed in a sturdy metal container with handy moulded compartments and an actual size illustrated grease-resistant lid label.

Size: 9-3/4" w. x 13-3/4" l. x 2" d.

239
Series

papco® MULTI-GRIP BLIND RIVETS RIVETS OBTURATEURS MULTI-GRIP

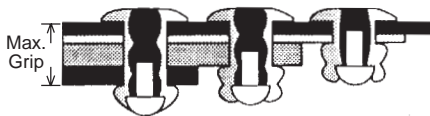

and soft materials needs fastening. Compensates for hole size and alignment variations. Aluminum body and steel mandrel. Domed head. Order by Stock Number.

These blind rivets cover the grip range of three standard rivets. Excellent where a combination of hard



Standard Package 100 rivets.

| Stock No. | Other No. | Rivet Dia. | Grip Range | Rivet Length |
|-----------|-----------|-------------|------------|--------------|
| 239-314 | AD41-43 | 1/8 (.125) | .031-.185 | .315 |
| 239-320 | AD43-45 | 1/8 (.125) | .157-.335 | .480 |
| 239-335 | AD52-54 | 5/32 (.156) | .047-.248 | .425 |
| 239-353 | AD62-64 | 3/16 (.187) | .063-.252 | .414 |

papco BACK-UP PLATES



239-493
239-494
239-492

Back-up plates for 1/8" dia. Rivets (9/64 x 3/8 x 1/32) Plated Steel, 100 per box.
Back-up plates for 3/16" dia. Rivets (13/64 x 1/2 x 3/64) Plated Steel, 100 per box.
Back-up plates for 3/16" dia. Rivets (13/64 x 1/2 x 3/64) Aluminum, 100 per box.

247
Series

papco

PLASTIC RIVETS
RIVETS EN PLASTIQUE



'Papco' Plastic expansion rivets are used to fasten panels, fascia strips, inner fenders, grilles, shields etc. Moulded of nylon, the three leg design draws panels tightly together as the mandrel breaks off.

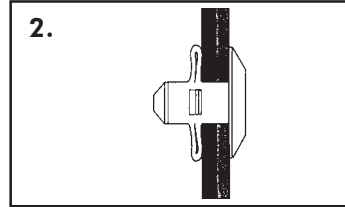
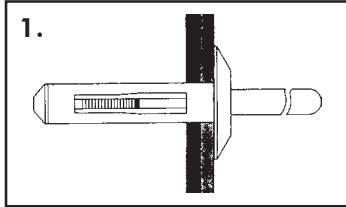

Order by Stock Number

Illustrations Actual Size

Standard Package 25 pieces.

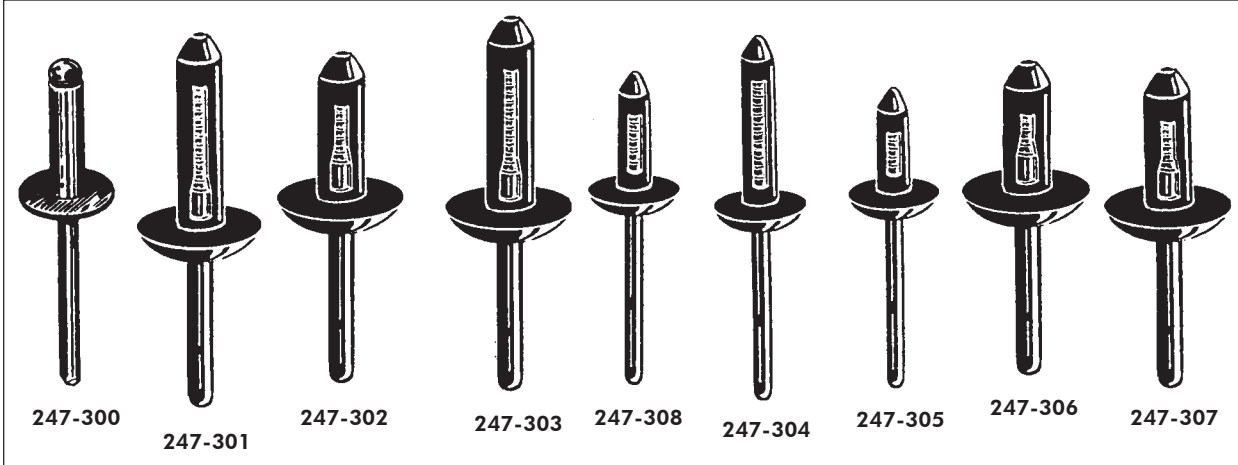

| Stock No. | Factory No. | Rivet Dia. | Max. Grip | Head Flange Dia | Drill Size |
|-----------|--|------------|-----------|-----------------|------------|
| 247-300 | Chrysler: 6500899, GM: 2043297 VW: 175-853-57701C | 5mm | 6mm | 12mm | 7/32 |
| 247-301 | Chrysler: 6500911 Ford: N803043-S GM: 14063981 | 6.3 | 10 | 17 | 1/4 |
| 247-302 | GM: 14070914 (White) | 6.3 | 6 | 17 | 1/4 |
| 247-303 | Ford: N803862-S GM: 20452072 | 6.3 | 10 | 13 | |
| 247-304 | GM: 20433026 VW: 175-853-577A | 6.6 | 5 | 17 | 9/32 |
| 247-305 | GM: 20421672 | 6.6 | 5 | 13 | 9/32 |
| 247-306 | Ford: N804189S, GM: 2042367 | 5 | 4.5 | 12 | 7/32 |
| 247-307 | Chrysler: 6500898 | 5 | 10 | 12 | 7/32 |
| 247-308 | 388664-S100 (Black) Ford Fascia & Bumper (Aluminum) | 3/16" | 1/2" | 9/16" | — |

For 'Papco' Plastic Rivets Master Assortment No. 020-693 see page 8.

papco

PLASTIC RIVET
SETTING TOOL

No. 247-330

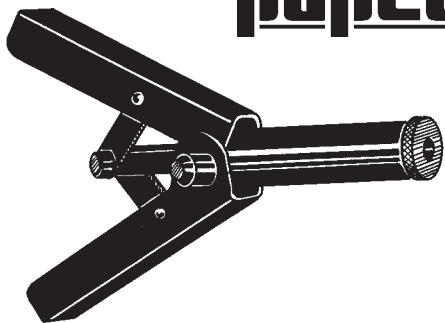

This sturdy steel tool sets all sizes of plastic rivets. The long reach gets into tight areas and the extra leverage allows fast, one-stroke setting. Used with Plastic Rivets above.

Order by Stock Number

Individually packaged.



239
Series

PAPCO BLIND WELL NUTS ECROUS PUIITS OBTURATEURS

Consists of a flanged neoprene bushing with a captive brass insert nut. As the screw is tightened the bushing expands making a secure fastening in thin sheet metal or blind holes. Use to mount accessories on cars, vans, trucks, snowmobiles, fiberglass boats etc.

Order by Stock Number Standard Package 10 Nuts

| Stock No. | Thread Size | Hole Size | Panel Thick. Max. | Flange Dia. | Shank Length |
|-----------|-------------|-----------|-------------------|-------------|--------------|
| 239-974 | 6-32 | 5/16 | .156" | .462" | .437" |
| 239-976 | 8-32 | 5/16 | .156 | .438 | .447 |
| 239-985 | 10-32 | 3/8 | .227 | .750 | .620 |
| 239-991 | 1/4-20 | 1/2 | .187 | .250 | .642 |

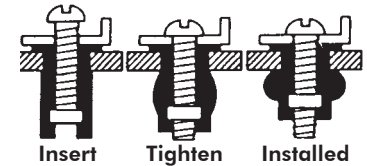

PAPCO MIRROR MOUNTING 'JACK' NUT No. 239-960

Made of 1010 Zinc Plated Steel this 1/4-20 Jack Nut with sealer has been designed for mounting outside mirrors to body panels. Legs of nut expand as screw is driven providing a positive, water-tight connection. Used with 'Papco' Body Bolt No. 245-610 on page 92. May also be used to attach licence plates.

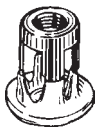

Standard Package 25 Pieces

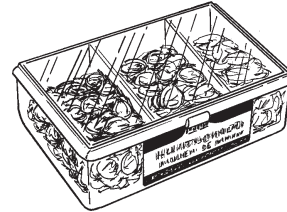

BLIND WELL NUT GARAGE ASSORTMENT No. 020-081

Contains 20 nuts in 6-32, 8-32, 10-32, and 1/4-20. Packed in a clear plastic box.

222
Series

PAPCO 'SERT - A - NUTS' ECROUS D'ANCRAGE

'Papco' Aluminum 'Sert-a-Nuts' may be used in sheet metal, plastic, castings, fiberglass, or any rigid material. 'Sert-a-Nut' has an unlimited grip range and no thickness barrier. Eliminates the need for tapping, welding or brazing. Kits include Setting Tool, Socket Screw and Hex Key.

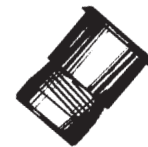

| | | | |
|---|--|---|---|
| <p>1.</p> <p>Place screw through tool and thread into 'Sert-a-Nut' flange side up</p> | <p>2.</p> <p>Insert 'Sert-a-Nut' into pre-drilled hole</p> | <p>3.</p> <p>Hold tool with wrench, turn screw with key until tight</p> | <p>4.</p> <p>'Sert-a-Nut' is now anchored solidly into hole</p> |
|---|--|---|---|

Order by Stock No.

'SERT-A-NUTS'

| Stock No. | Size | Drill | Std. Pkg. |
|-----------|--------|-------|-----------|
| 222-304 | 6-32 | 7/32 | 25 |
| 222-306 | 8-32 | 1/4 | 25 |
| 222-308 | 10-24 | 9/32 | 25 |
| 222-310 | 1/4-20 | 3/8 | 25 |

'SERT-A-NUT' KITS

| Stock No. | Size | Drill | Ins. per Kit |
|-----------|--------|-------|--------------|
| 222-314 | 6-32 | 7/32 | 5 |
| 222-316 | 8-32 | 1/4 | 5 |
| 222-318 | 10-24 | 9/32 | 5 |
| 222-320 | 1/4-20 | 3/8 | 5 |

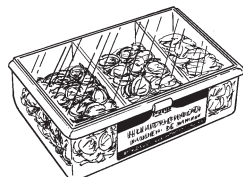

'SERT - A - NUT' GARAGE ASSORTMENT No. 020-090

Contains 4 complete kits for 6-32, 8-32, 10-24 and 1/4-20 'Sert-a-Nuts'.

Four sizes in a clear plastic box.

239
Series

papco WELD PINS
GOUPILLES A SOUDER



'Papco' Steel Weld Pins (Copper Plated) are used extensively for removing dents in quarter panels, fenders, doors etc. Pins are welded in place then dents are pulled out by using a gripping tool to pull dent out of damaged body panel area. Pins are then ground off. Copper Plated for increased conductivity.



Order by Stock No.

Standard Package 100 Pieces

| Stock No. | Size | Stock No. | Size |
|-----------|-----------------------------|-----------|-------------------------------|
| 239-900 | 2 mm (.080") Dia. x 2" Long | 239-901 | 2.5 mm (.098") Dia. x 2" Long |

Bulk quantities available - price on application.

240
Series

papco FLAT TYPE SPEED NUTS
ECROUS TENIR TYPE FRAISSE

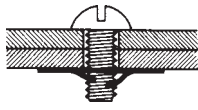





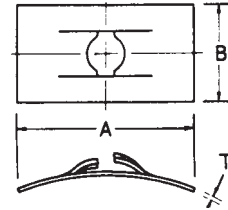



Flat Type

Used with machine screws and sheet metal screws. One piece, heat treated spring steel self-locking fastener. The original equipment fastener used on headlights, radiators, moulding, trim, gravel deflectors, ornaments, emblems, name plates, etc.



Order by Stock Number

Standard Package contains 100 Speed Nuts

| | | | |
|---|---|---|---|
|  |  |  |  |
| 240-089 6-32 Screw | 240-091 6-32 Screw | 240-100 8-32 Screw | 240-101 8-32 Screw |
|  |  |  |  |
| 240-120 10-24 Screw | 240-159 1/4"-20 Screw | 240-108 No. 8 Screw | 240-127 No. 10 Screw |

Actual Size Illustrations

| Stock No. | Screw Size | Dimensions A x B x T | Other No. | Application |
|-----------|------------|-------------------------|-----------|--|
| 240-089 | 6-32 | 1/2 x 5/16 x .017 | 2089 | General Purpose. |
| 240-091 | 6-32 | 7/8 x 1/2 x .017 | 1898 | Chrysler prod. garish moulding ornament. |
| 240-100 | 8-32 | 1/2 x 5/16 x .017 | 2091 | General Purpose. |
| 240-101 | 8-32 | 7/8 x 1/2 x .017 | 1899 | Chrysler prod. rad and trunk medallion. |
| 240-120 | 10-24 | 3/4 x 7/16 x .022 | 2092 | General Purpose. |
| 240-159 | 1/4-20 | 1" x 9/16 x .027 | 1903 | General Purpose. |
| 240-108 | No. 8 | 5/8 x 11/32 x .031 | 3793 | For sheet metal screws. |
| 240-127 | No. 10 | 7/8 x 1/2 x .031 | 1900 | For sheet metal screws, and rad. grille. |

**SPEED NUT
GARAGE ASSORTMENT No. 020-015**

Contains 8 sizes of Flat Type Speed Nuts, 160 pieces. Packed in handy, clear plastic box, with moulded compartments.





240
Series

papeco

FORMED TYPE SPEED NUTS
ECROUS TENIR TYPE FORME



'J' Types



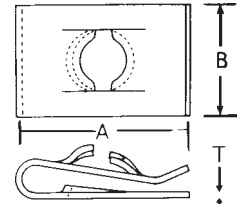







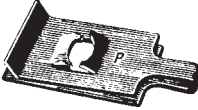

Used with Machine Screws and Sheet Metal Screws. Two types, 'U' and 'J'. Press into locked on position over panel edge or in centre-panel location. Holds itself in screw receiving position.

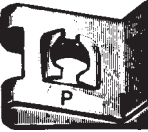

'U' Types

Order by Stock Number

Standard Package contains 100 Speed Nuts

| | | | | |
|---|--|--|--|--|
|  240-243 10-24 Screw |  240-263 1/4"-20 Screw |  240-226 No. 8 Screw |  240-228 No. 8 Screw |  240-232 No. 8 Screw |
|  240-242 No. 10 Screw |  240-247 No. 10 Screw |  240-250 No. 10 Screw |  240-266 No. 12 Screw |  240-267 No. 14 Screw |
|  240-268 No. 14 Screw |  240-274 1/4"-20 Screw |  240-276 5/16"-18 Screw |  240-278 3/8"-16 Screw | |

Actual Size Illustrations

| Stock No. | Screw Size | Type | Dimensions | | | Other No. | Application |
|-------------------------------|------------|------|------------|---------|--------|-----------|--|
| | | | A | x B | x T | | |
| 240-243 | 10-24 | U | 41/64 | x 7/16 | x .020 | 5197 | General Purpose. |
| 240-263 | 1/4-20 | U | 63/64 | x 1/2 | x .025 | 2293 | License Plate attaching nut. |
| FOR SHEET METAL SCREWS | | | | | | | |
| 240-226 | No. 8 | U | 31/64 | x 1/2 | x .028 | 3796 | Chev. Headlamp adj. nut, Rad. grille assembly. |
| 240-228 | No. 8 | U | 41/64 | x 7/16 | x .028 | 10666 | Ford quarter trim to panel. |
| 240-232 | No. 8 | U | 3/4 | x 7/16 | x .029 | 11292 | General Purpose. |
| 240-242 | No. 10 | J | 1" | x 1/2 | x .035 | 8341 | General Purpose. |
| 240-247 | No. 10 | J | 15/32 | x 11/16 | x .031 | 2303 | Chevrolet Headlamp to fender. |
| 240-250 | No. 10 | U | 3/4 | x 1/2 | x .031 | 2422 | Ford radiator grille. |
| 240-266 | No. 12 | U | 7/8 | x 9/16 | x .034 | 1910 | General Purpose. |
| 240-267 | No. 14 | J | 7/8 | x 9/16 | x .034 | 2420 | Olds. front fender rad. to grille 3/32" panel. |
| 240-268 | No. 14 | J | 7/8 | x 9/16 | x .034 | 2057 | Olds. Pontiac, fender and rad. 3/64" panel. |
| 240-274 | 1/4-20 | J | 7/8 | x 5/8 | x .300 | 5586 | General Purpose 'J' Type Cage Nut |
| 240-276 | 5/16-18 | J | 1-1/16 | x 3/4 | x .300 | 5589 | General Purpose 'J' Type Cage Nut |
| 240-278 | 3/8-16 | J | 1-1/8 | x 3/4 | x .300 | 5170 | General Purpose 'J' Type Cage Nut |

SPEED NUT
GARAGE ASSORTMENT No. 020-016

Contains 8 sizes of 'U' and 'J' Formed Type Speed Nuts, 65 pieces. Packed in handy, clear plastic box with compartments.





240
Series

papeo

**PUSH-ON TYPE SPEED NUTS
ECROUS TENIR TYPE POUSEE**

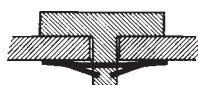



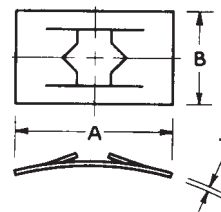







For use on studs, rivets and other unthreaded parts. Teeth bite inward and arched shape provides secure spring grip.



Push-On Type

Order by Stock Number

Standard Package contains 100 Speed Nuts

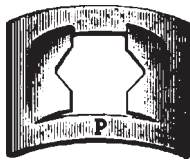
| | | | |
|---|---|--|---|
|  240-310 1/16" Stud |  240-320 3/32" Stud |  240-325 .100 Stud |  240-331 1/8" Stud |
|  240-335 1/8" Stud |  240-340 5/32" Stud |  240-345 5/32" Stud |  240-350 3/16" Stud |
|  240-355 1/4" Stud |  240-365 5/16" Stud |  240-370 3/8" Stud | |

Actual Size Illustrations

| Stock No. | Screw Size | Dimensions | | | Other No. | Application |
|-----------|------------|------------|---------|--------|-----------|---|
| | | A | x B | x T | | |
| 240-310 | 1/16 | 25/64 | x 7/32 | x .012 | 2098 | Buick seat trim, Chrysler name plate. |
| 240-320 | 3/32 | 7/16 | x 7/32 | x .017 | 2100 | For Hardened Studs, Pontiac name plate. |
| 240-325 | .100 | 29/64 | x 15/64 | x .014 | 1906 | General Purpose. |
| 240-331 | 1/8 | 3/8 | x 11/32 | x .019 | 3559 | General Purpose. |
| 240-335 | 1/8 | 37/64 | x 5/16 | x .012 | 2099 | General Purpose. |
| 240-340 | 5/32 | 3/4 | x 7/16 | x .020 | 1905 | General Purpose. |
| 240-345 | 5/32 | 9/16 | x 3/8 | x .012 | 2102 | General Purpose. |
| 240-350 | 3/16 | 5/8 | x 3/8 | x .017 | 2103 | Ford products name plate, ornament. |
| 240-355 | 1/4 | 41/64 | x 7/16 | x .017 | 2105 | General Purpose. |
| 240-365 | 5/16 | 3/4 | x 17/32 | x .020 | 3138 | General Purpose. |
| 240-370 | 3/8 | 13/16 | x 5/8 | x .020 | 3139 | General Purpose. |

**SPEED NUT
GARAGE ASSORTMENT No. 020-017**

Contains 7 sizes of Push-On Type Speed Nuts, 160 pieces. Packed in a rigid clear plastic container with handy compartments.





240
Series

papco® TUBULAR TYPE SPEED CLIPS ECROUS TENIR TYPE A TUBE

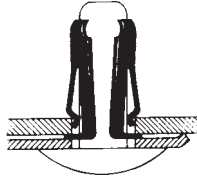





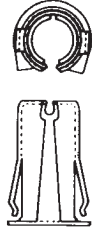

Tubular Type

Used on unthreaded studs and rivets where there is access to only one side of the assembly. Insert Speed Clips into hole causing cam-like side prongs to snap and hold clip in proper position. Push rivet end into clip causing turned-in end of clip to bite rivet and lock it securely.



Order by Stock Number

Standard Package contains 100 Speed Clips

| Actual Size Illustrations | | | | | |
|---|---|---|--|---|---|
| Stock No. | Stud Dia. | Panel Range | Fits Hole | Other No. | Factory No. |
|  |  |  |  |  |  |
| 240-430 1/8" Stud | 240-431 1/8" Stud | 240-432 1/8" Stud | 240-469 5/32" Stud | 240-471 3/16" Stud | 240-472 3/16" Stud |
| 240-430 | 1/8 | .030" - .036" | 5/32 | 2611 | — |
| 240-431 | 1/8 | .040" - .045" | 3/16 | 2595 | — |
| 240-432 | 1/8 | .036" - .046" | 1/4 | 5195 | 3783794 |
| 240-469 | 5/32 | .062" - .068" | 7/32 | 8545 | — |
| 240-471 | 3/16 | .038" - .044" | 7/32 | 10073 | 6000558 |
| 240-472 | 3/16 | 17/64 Barrel Length | 17/64 | 13966 | 8934-201-767 |

SPEED NUT GARAGE ASSORTMENT No. 020-018

Contains 6 sizes of Tubular Speed Clips, for studs, 70 pieces. Packed in clear plastic container with easy to use compartments.



papco® Speed Nut UTILITY ASSORTMENTS

020-315



FLAT TYPE

8 sizes for Machine and Sheet Metal Screws, 325 pieces.

020-316



FORMED TYPE

10 sizes, 'U' and 'J' types for Machine and Sheet Metal Screws, 110 pieces.

020-317



PUSH-ON and TUBULAR

14 sizes for unthreaded Studs, 275 pieces.

All 'Papco' Utility Assortments are packed in sturdy fibreboard metal-edged boxes with individual compartments and with illustrated labels showing parts and prices.

papeo® Speed Nut MASTER ASSORTMENTS



MASTER ASSORTMENT No. 020-643

FOR UNTHREADED STUDS

Contains 7 Sizes Tubular Speed Clips
14 Sizes Push-On Speed Nuts
467 pieces selected according to popularity.

Name plates, emblems, moulding clips are held with Tubular Speed Clips and Push-on Speed Nuts. These kits will service every need that will come up in your shop.



MASTER ASSORTMENT No. 020-644 FOR MACHINE and SHEET METAL SCREWS

Contains 12 Sizes Flat Type Speed Nuts,
14 Sizes Formed Type Speed Nuts
421 pieces balanced for popularity.

Every year more and more Speed Nuts are used for Original Equipment attachments. These handy kits contain the Speed Nuts that are most frequently replaced on all makes of cars.



Size: 9-34" w. x 13-3/4" l. x 2" d.

papeo SUPER SERVICE ASSORTMENT No. 020-810

SPEED NUT SUPER-SERVICE ASSORTMENT No. 020-810

- Contains 685 Speed Nuts in Flat, Push-on and Formed Types – 32 sizes.
- Large size, rigid metal box with high-strength plastic compartments.
- Convenient, safety snap carrying handle.
- Actual size illustrations and retail codes of every item shown on grease-resistant lid label.
- Refills available in standard packages.

Ideal for Dealers, Jobbers and large users. This popular assortment contains a wide range of Flat Push-on and Formed Type Speed Nuts carefully



selected in balanced quantities.

Size: 12" w. x 18" l. x 3" d.

papeo SUPER SERVICE ASSORTMENT No. 020-823

Contains 325 'U' Nuts and Body Bolts – 22 items.
Large size, rigid metal box with high-strength plastic compartments.
For more details see page 9. Large size: 12" w. x 18" l. x 3" d.

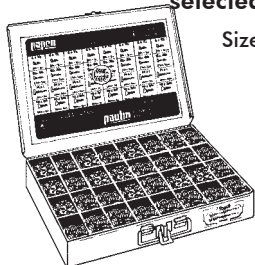



papeco® 'PALNUT' LOCK NUTS ECROUS 'A BLOCAGE 'PALNUT'

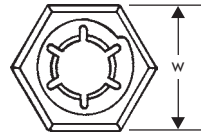

242
Inch

REGULAR TYPE
BRIGHT ZINC PLATED

243
Metric

Spring steel, single thread lock nuts. May be used alone or on top of ordinary nuts.

Order by Stock Number Standard Package 50 pieces

| INCH | | | METRIC | | |
|-----------|---------------|------------------|-----------|------|------------------|
| Stock No. | Size & Thread | Across Flats 'W' | Stock No. | Size | Across Flats 'W' |
| 242-016 | 5/16-24 | 1/2" | 243-004 | M4 | 9mm |
| 242-018 | 3/8-24 | 9/16" | 243-005 | M5 | 13mm |
| 242-020 | 7/16-20 | 5/8" | | | |
| 242-022 | 1/2-20 | 3/4" | | | |

HEX WASHER TYPE BRIGHT ZINC PLATED

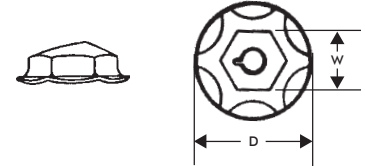

Integral washers on these lock nuts span slots or clearance holes. This spring locking action of the washer provides a secure assembly.

Order by Stock Number Standard Package 50 pieces

| INCH | | | METRIC | | |
|-----------|---------------|--------------|-----------|------|-------------|
| Stock No. | Size & Thread | 'W' x 'D' | Stock No. | Size | 'W' x 'D' |
| 242-108 | 8-32 | 11/32 x 5/8 | 243-105 | M5 | 10mm x 13mm |
| 242-110 | 10-24 | 3/8 x 3/4 | 243-106 | M6 | 11mm x 18mm |
| 242-114 | 1/4-20 | 7/16 x 11/16 | | | |
| 242-116 | 5/16-18 | 1/2 x 13/16 | | | |

GARAGE ASSORTMENT No. 020-074

Contains 100 pieces of all Inch sizes of Palnut Lock Nuts both regular and washer types. Packed in a sturdy, plastic box.

GARAGE ASSORTMENT No. 020-075

Contains 100 pieces of all Metric size Palnut Lock Nuts in both regular and washer types. Packed in a clear, plastic box.



papeco® SELF-THREADING 'PALNUTS' 'PALNUTS' A FILETAGE COUPANT

These washer base, heat treated nuts cut their own threads on plain studs, nameplates, ornaments and mouldings. The mastic sealer type protects against dirt and moisture.

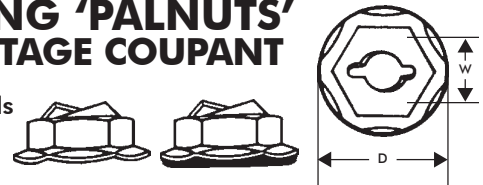

Order by Stock Number

BRIGHT ZINC PLATED

Standard Package 50 pieces

| Stock No. | Stud Size | Type | 'W' x 'D' | Stock No. | Stud Size | Type | 'W' x 'D' |
|-----------|-----------|---------|--------------|-----------|-----------|---------|--------------|
| 242-206 | 1/8 | Regular | 5/16 x 7/16 | 242-210 | 3/16 | Regular | 3/8 x 1/2 |
| 242-207 | 1/8 | Sealer | 5/16 x 7/16 | 242-211 | 3/16 | Sealer | 3/8 x 1/2 |
| 242-208 | 5/32 | Regular | 11/32 x 9/16 | 242-214 | 1/4 | Regular | 7/16 x 11/16 |
| 242-209 | 5/32 | Sealer | 11/32 x 9/16 | 242-215 | 1/4 | Sealer | 7/16 x 11/16 |
| | | | | 242-216 | 5/16 | Regular | 1/2 x 7/8 |

papeco® METRIC SELF-THREADING 'PALNUTS' 'PALNUTS' A FILETAGE COUPANT METRIQUE

Order by Stock Number

BRIGHT ZINC PLATED

Standard Package 50 pieces

| Stock No. | Stud Size | Type | 'W' x 'D' | Stock No. | Stud Size | Type | 'W' x 'D' |
|-----------|-----------|---------|------------|-----------|-----------|---------|-------------|
| 243-204 | 4mm | Regular | 9mm x 15mm | 243-205 | 5mm | Regular | 10mm x 15mm |

SELF-THREADING 'PALNUT' GARAGE ASSORTMENT No. 020-052

Contains 100 nuts of 1/8, 5/32, 3/16, 1/4 and 5/16 Self-Threading Palnuts in both Regular and Sealer types. Packed in a clear, plastic box.



242
Inch

243
Metric

papeco BOLT RETAINERS RETENUE DE BOULON



BLACK PHOSPHATE FINISH

These fasteners are pushed onto a screw or bolt of either coarse or fine thread to hold it in place during assembly. When the regular nut is tightened the retainer is left in place.

Order by Stock Number

Standard Package 100 Pieces

| INCH | | | METRIC | | |
|-----------|--------------------|------------------|-----------|--------------------|------------------|
| Stock No. | Screw or Bolt Dia. | Outside Diameter | Stock No. | Screw or Bolt Dia. | Outside Diameter |
| 242-308 | 5/32 | 3/8" | 243-306 | M6 | 17.0mm |
| 242-310 | 3/16 | 7/16" | 243-307 | M6.3 | 14.3mm |
| 242-314 | 1/4 | 1/2" | 243-308 | M8 | 25.0mm |
| 242-316 | 5/16 | 5/8" | 243-310 | M10 | 24.0mm |
| 242-318 | 3/8 | 25/32" | 243-312 | M12 | 21.4mm |
| 242-320 | 7/16 | 27/32" | 243-314 | M14 | 25.0mm |
| 242-322 | 1/2 | 15/16" | | | |

GARAGE ASSORTMENT No. 020-076

Contains 100 Inch retainers in 1/4, 5/16, 3/8, 7/16 and 1/2. Packed in a sturdy, transparent plastic box.



GARAGE ASSORTMENT No. 020-077

Contains 100 Metric Retainers in M6, M8, M10 and M12. Packed in a clear, plastic, compartmentized box

papeco 'PUSHNUT' FASTENERS ATTACHES 'PUSHNUT'

BRIGHT ZINC PLATED



These flat, round type, spring steel fasteners are pushed on unthreaded rods, studs, etc. Used on nameplates, moulding studs and shafts.

Order by Stock Number

Standard Package 100 Pieces

| Stock No. | Stud Size | Outside Diameter | Stock No. | Stud Size | Outside Diameter |
|-----------|-----------|------------------|-----------|-----------|------------------|
| 242-401 | 1/16 | .195" | 242-413 | .240 | 17/32" |
| 242-403 | 3/32 | .195" | 242-414 | 1/4 | 17/32" |
| 242-406 | 1/8 | 3/8" | 242-416 | 5/16 | 5/8" |
| 242-408 | 5/32 | 7/16" | 242-418 | 3/8 | 3/4" |
| 242-410 | 3/16 | 7/16" | 242-422 | 1/2 | 1" |

papeco METRIC 'PUSHNUT' FASTENERS ATTACHES 'PUSHNUT' METRIQUE

BLUE ZINC PLATED

Order by Stock Number

Standard Package 100 Pieces

| Stock No. | Stud Size | Outside Diameter | Stock No. | Stud Size | Outside Diameter |
|-----------|-----------|------------------|-----------|-----------|------------------|
| 243-403 | 3.2mm | 9.5mm | 243-405 | 5.0mm | 11.0mm |
| 243-404 | 4.0mm | 11.0mm | | | |



GARAGE ASSORTMENT No. 020-084

Contains 100 Pushnut Fasteners in both Inch and Metric - 10 sizes in all. Packed in a transparent plastic box with hinged lid.

papeco MASTER ASSORTMENT No. 020-674

Contains 325 pieces - 20 popular sizes of Regular and Self-Threading Palnuts plus Bolt Retainers and Pushnuts. Packed in a metal box with moulded plastic compartments.

Size: 9-3/4"w. x 13-3/4"l. x 2"d.



papeco SUPER SERVICE ASSORTMENT No. 020-811

Contains 500 Regular and Self Threading Palnuts plus Bolt Retainers and Pushnuts - 32 items. Large size, rigid metal box with high-strength plastic compartments. For more details see page 9. Large size 18" l. x 3" d.

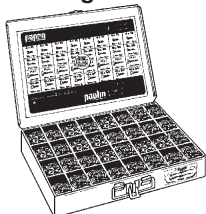



240
INCH

241
METRIC

papeco MULTI-THREAD 'U' NUTS
ECROUS 'U' FILET MULTIPLE

PHOSPHATE COATED

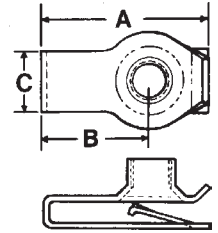

Spring steel nut fastens two panels, is retained in one panel. Used for sheet metal and front end assembly on GM, Ford or Chrysler fenders, shrouds and radiators, etc.

Order by Stock Number

Standard Package 25 Pieces (*10 Pcs.)

| INCH | | | | | | | METRIC | | | | | | |
|-----------|--------------------|------------|------------------|-----------|-----------------|-------------|-----------|--------------------|------------|------------------|-----------|-----------------|-------------|
| Stock No. | Bolt or Screw Size | Length 'A' | Throat Depth 'B' | Width 'C' | Panel Thickness | Factory No. | Stock No. | Bolt or Screw Size | Length 'A' | Throat Depth 'B' | Width 'C' | Panel Thickness | Factory No. |
| 240-614 | 1/4-20 | 0.920 | 0.540 | 0.520 | 0.150 | 1494252 | 241-604 | M4x.7 | 21.5 | 10.5 | 11.0 | 3.8 | 11500654 |
| 240-615 | 1/4-20 | 1.250 | 0.8125 | 0.520 | 0.150 | 45267 | 241-605 | M4x.7 | 22.0 | 14.5 | 10.0 | 3.8 | 11500655 |
| 240-616 | 5/16-18 | 0.980 | 0.580 | 0.580 | 0.150 | 45264 | 241-606 | M6x1.0 | 24.0 | 13.7 | 13.0 | 4.0 | 11503714 |
| 240-617 | 5/16-18 | 1.250 | 0.875 | 0.580 | 0.150 | 379831-S | 241-607 | M6x1.0 | 30.0 | 20.0 | 13.0 | 4.0 | 11503715 |
| 240-618 | 3/8-16 | 1.670 | 1.100 | 0.720 | 0.200 | 45269-S2 | 241-608 | M8x1.25 | 32.0 | 21.5 | 14.7 | 4.0 | 11500661 |
| 240-619 | 3/8-16 | 1.3125 | 0.750 | 0.9375 | 0.200 | 1494254 | 241-609 | M8x1.25 | 25.5 | 15.0 | 14.7 | 4.0 | 11500660 |
| | | | | | | | 241-610* | M10x1.5 | 33.0 | 19.0 | 18.0 | 6.0 | 11500662 |
| | | | | | | | 241-612 | M6.3x1.0 | 24.0 | 20.0 | 13.5 | 4.0 | 11500658 |

For Body Bolts see page 92.

MULTI-THREAD 'U' NUT GARAGE ASSORTMENT No. 020-078

Contains 65 Inch Multi-Thread 'U' Nuts. 4 sizes each in its own compartment. Packed in a sturdy, transparent plastic box with hinged lid.



MULTI-THREAD 'U' NUT GARAGE ASSORTMENT No. 020-079

Contains 50 Metric Multi-Thread 'U' Nuts. 7 sizes packed in a clear plastic box with hinged lid.

240
INCH

papeco SINGLE THREAD 'U' NUTS
ECROUS 'U' FILET-UNE

PHOSPHATE COATED

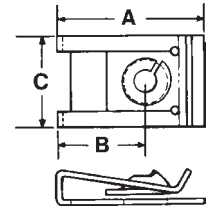

Order by Stock Number

Standard Package 25 Pieces

| Stock No. | Screw Size | Length 'A' | Throat Depth 'B' | Width 'C' | Panel Thickness | Factory No. | Stock No. | Screw Size | Length 'A' | Throat Depth 'B' | Width 'C' | Panel Thickness | Factory No. |
|-----------|------------|------------|------------------|-----------|-----------------|-------------|-----------|------------|------------|------------------|-----------|-----------------|-------------|
| 240-706 | No. 6 | 0.890 | 0.375 | 0.575 | 0.125 | 9424837 | 240-714 | No. 14 | 0.785 | 0.344 | 0.650 | 0.156 | 45258 |
| 240-708 | No. 8 | 0.785 | 0.375 | 0.550 | 0.125 | 9431530 | 240-715 | No. 14 | 1.000 | 0.563 | 0.650 | 0.156 | 45261 |
| 240-709 | No. 8 | 1.000 | 0.625 | 0.550 | 0.125 | 11504531 | 240-726 | M6.3 | 0.988 | 0.845 | 0.640 | 0.340 | — |
| 240-710 | No. 10 | 0.785 | 0.344 | 0.650 | 0.125 | 152492 | | | | | | | |

SINGLE THREAD 'U' NUT GARAGE ASSORTMENT No. 020-080

Contains 65 Single Thread 'U' Nuts. 5 sizes packed in a transparent plastic box with hinged lid.

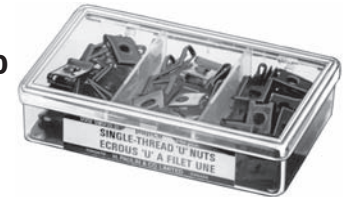

'U' NUT MASTER ASSORTMENT No. 020-692

Contains 100 'U' Nuts in both Multi-Thread and Single Thread types. Packed in a metal box with high-strength plastic compartments.

Total of 20 sizes Inch, Metric for Complete Coverage.

245
Series



BODY BOLTS
BOULONS DE CARROSSERIE



Special Indented Hexagon Head Bolts with aligning points for pre-drilled panels. Phosphate finish.

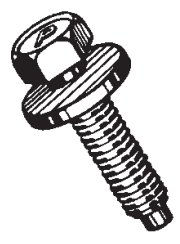

Type 1
Conical
Washer Head
Dog-Point

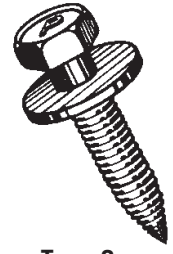

Type 2
Conical
Washer Head



Type 3
Hex Washer
Head



Type 4
Hex Head
Sems

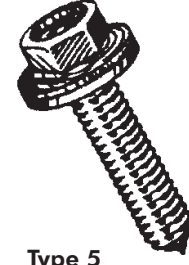

Type 5
Nylon Washer
Hex Washer
Head

Order by Stock Number

Standard Package 25 pieces *15 pcs.

| Stock No. | Size | Type | Washer O.D. | Factory No. | Stock No. | Size | Type | Washer O.D. | Factory No. |
|-----------|--------------|------|-------------|-------------|-----------|----------------|------|-------------|-------------|
| 245-322 | M6x1.0x22 | 1 | 19mm | N-606676 | 245-505 | M6x1.0x20 | 3 | 13mm | 11503800 |
| 245-325 | M6x1.0x30 | 1 | 19mm | 6100568 | 245-507 | M6x1.0x25 | 3 | 13mm | 11503958 |
| 245-400 | M4.2x1.41x20 | 4 | 16mm | 11500434 | 245-510 | M6x1.0x35 | 2 | 17mm | 11505044 |
| 245-405 | M6x1.0x20 | 2 | 17mm | 11502941 | 245-525 | M8x1.25x25 | 3 | 17mm | 11503632 |
| 245-407 | M6x1.0x25 | 2 | 17mm | 11503834 | 245-527 | M8x1.25x30 | 3 | 17mm | 11500971 |
| 245-408 | M6x1.0x25 | 2 | 24mm | 11503982 | 245-610 | 1/4-20x11/4S/S | 5 | 5/8 | 14007511 |
| 245-420 | M6.3x1.0x20 | 2 | 17mm | 11501105 | 245-615 | 5/16-18x7/8 | 2 | 11/16 | 3846202 |
| 245-424 | M6.3x1.0x25 | 2 | 18mm | 11500754 | 245-616 | 5/16-18x1 | 2 | 7/8 | 3968521 |
| 245-425 | M6.3x1.0x25 | 2 | 24mm | 365718 | 245-620 | 3/8-16x1 | 2 | 1" | 3986997 |
| 245-440 | M8x1.25x30 | 2 | 24mm | 11501188 | 245-630 | 3/8-16x11/2 | 2 | 11/8 | 407217 |
| 245-450* | M10x1.5x40 | 2 | 30mm | 11501193 | | | | | |

For Body Bolt `U` Nuts see page 91.

BODY BOLTS ASSORTMENT
MASTER ASSORTMENT No. 020-691

Contains 150 Body Bolts - 20 sizes. Packed in a metal box with high-strength plastic compartments. Every item is fully illustrated on a grease resistant lid label.

Size: 9-3/4" w. x 13-3/4" l. x 2" d.



For SUPER-SERVICE Assortment No. 020-823 of `U` Nuts and Body Bolts see page 88.



POWER STEERING CAPS
BOUCHONS POUR POMPE DE SERVO-DIRECTION

Replacement units for lost or broken original equipment Power Steering Pump Caps. Individually Packaged.



Order by Stock Number

| Stock No. | Description | Stock No. | Description |
|-----------|-------------|-----------|-------------|
| 249-150 | GM | 249-152 | FORD |



244
Series

papco® METRIC FLANGE HEX BOLTS BOULONS DE REBORD METRIQUE

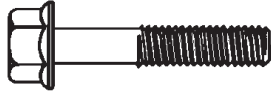
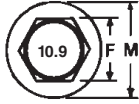

IFI SPEC (SMALL HEAD) • ZINC PLATED STEEL

Used for automotive body applications and general use where large bearing contact is required over clearance holes or softer material. Conform to Metric Property Class 10.9 (slightly 9% stronger than S.A.E. Grade 8).

Order by Stock Number

| Stock No. | Dia. x Pitch x Length | Hex `F` mm | Flange `M` mm | Std. Pkg. | Stock No. | Dia. x Pitch x Length | Hex `F` mm | Flange `M` mm | Std. Pkg. |
|-----------|-----------------------|---------------|------------------|--------------|-----------|-----------------------|---------------|------------------|--------------|
| 244-267 | M6x1.0x12mm | 8 | 13 | 20 | 244-323 | M8x1.25x45mm | 10 | 16.5 | 20 |
| 244-270 | M6x1.0x16mm | 8 | 13 | 20 | 244-324 | M8x1.25x50mm | 10 | 16.5 | 15 |
| 244-272 | M6x1.0x20mm | 8 | 13 | 20 | 244-326 | M8x1.25x60mm | 10 | 16.5 | 15 |
| 244-274 | M6x1.0x25mm | 8 | 13 | 20 | 244-328 | M8x1.25x70mm | 10 | 16.5 | 15 |
| 244-276 | M6x1.0x30mm | 8 | 13 | 20 | 244-364 | M10x1.25x16mm | 13 | 20 | 15 |
| 244-277 | M6x1.0x35mm | 8 | 13 | 20 | 244-366 | M10x1.25x20mm | 13 | 20 | 15 |
| 244-278 | M6x1.0x40mm | 8 | 13 | 20 | 244-368 | M10x1.25x25mm | 13 | 20 | 15 |
| 244-279 | M6x1.0x45mm | 8 | 13 | 20 | 244-370 | M10x1.25x30mm | 13 | 20 | 15 |
| 244-311 | M8x1.25x12mm | 10 | 16.5 | 20 | 244-371 | M10x1.25x35mm | 13 | 20 | 15 |
| 244-314 | M8x1.25x16mm | 10 | 16.5 | 20 | 244-372 | M10x1.25x40mm | 13 | 20 | 15 |
| 244-316 | M8x1.25x20mm | 10 | 16.5 | 20 | 244-373 | M10x1.25x45mm | 13 | 20 | 15 |
| 244-318 | M8x1.25x25mm | 10 | 16.5 | 20 | 244-374 | M10x1.25x50mm | 13 | 20 | 15 |
| 244-320 | M8x1.25x30mm | 10 | 16.5 | 20 | 244-376 | M10x1.25x60mm | 13 | 20 | 15 |
| 244-321 | M8x1.25x35mm | 10 | 16.5 | 20 | 244-378 | M10x1.25x70mm | 13 | 20 | 10 |
| 244-322 | M8x1.25x40mm | 10 | 16.5 | 20 | | | | | |

611
Series

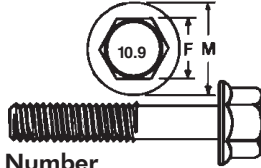

JIS SPEC B1189 • ZINC PLATED STEEL

Used primarily in Asian import applications and general use where large bearing contact is required over clearance holes or softer material. Conform to Metric Property Class 10.9 (slightly 9% stronger than S.A.E. Grade 8).

Order by Stock Number

| Stock No. | Dia. x Pitch x Length | Hex `F` mm | Flange `M` mm | Std. Pkg. | Stock No. | Dia. x Pitch x Length | Hex `F` mm | Flange `M` mm | Std. Pkg. |
|-----------|-----------------------|---------------|------------------|--------------|-----------|-----------------------|---------------|------------------|--------------|
| 611-267 | M6x1.0x12mm | 10 | 14 | 20 | 611-320 | M8x1.25x30mm | 12 | 17.5 | 20 |
| 611-270 | M6x1.0x16mm | 10 | 14 | 20 | 611-321 | M8x1.25x35mm | 12 | 17.5 | 20 |
| 611-272 | M6x1.0x20mm | 10 | 14 | 20 | 611-322 | M8x1.25x40mm | 12 | 17.5 | 20 |
| 611-274 | M6x1.0x25mm | 10 | 14 | 20 | 611-324 | M8x1.25x50mm | 12 | 17.5 | 15 |
| 611-276 | M6x1.0x30mm | 10 | 14 | 20 | 611-364 | M10x1.25x16mm | 14 | 21 | 15 |
| 611-277 | M6x1.0x35mm | 10 | 14 | 20 | 611-366 | M10x1.25x20mm | 14 | 21 | 15 |
| 611-278 | M6x1.0x40mm | 10 | 14 | 20 | 611-368 | M10x1.25x25mm | 14 | 21 | 15 |
| 611-311 | M8x1.25x12mm | 12 | 17.5 | 20 | 611-370 | M10x1.25x30mm | 14 | 21 | 15 |
| 611-314 | M8x1.25x16mm | 12 | 17.5 | 20 | 611-371 | M10x1.25x35mm | 14 | 21 | 15 |
| 611-316 | M8x1.25x20mm | 12 | 17.5 | 20 | 611-372 | M10x1.25x40mm | 14 | 21 | 15 |
| 611-318 | M8x1.25x25mm | 12 | 17.5 | 20 | | | | | |

papco® METRIC FLANGE NUTS ECROUS DE REBORD METRIQUE

PHOSPHATE COATED



Type 1



Type 3
Free Spin

Use with `Papco` Metric Body Bolts or where oversize clearance holes or low compressive strength materials are being bolted. Metric Property Class 9.

Order by Stock Number

Standard Package 25 Pieces

| Stock No. | Dia. x Pitch | Hex `F` mm | Thick `H` mm | Flange `M` mm | Type | Factory No. | Stock No. | Dia. x Pitch | Hex `F` mm | Thick `H` mm | Flange `M` mm | Type | Factory No. |
|-----------|--------------|---------------|-----------------|------------------|------|-------------|-----------|--------------|---------------|-----------------|------------------|------|-------------|
| 244-956 | M6x1.0 | 10 | 5 | 16 | 3 | 11503752 | 244-987 | M8x1.25 | 13 | 8 | 17.6 | 1 | 11501889 |
| 244-957 | M6x1.0 | 11 | 9.5 | 19 | 3 | 11503754 | 244-988 | M10x1.50 | 15 | 11.2 | 21.5 | 1 | 11501850 |
| 244-958 | M6.3x1.0 | 11 | 9 | 16 | 3 | 11501106 | 244-990 | M12x1.75 | 18 | 13.5 | 25.6 | 1 | 11502723 |
| 244-986 | M6x1.0 | 10 | 6.7 | 14.2 | 1 | 11503745 | | | | | | | |

ZINC PLATED STEEL

Order by Stock Number

Standard Package 25 Pieces

| Stock No. | Dia. x Pitch | Hex `F` mm | Thick `H` mm | Flange `M` mm | Type | Factory No. |
|-----------|--------------|---------------|-----------------|------------------|------|-------------|
| 244-996 | M6x1.0 | 10 | 6.7 | 13 | 2 | — |
| 244-997 | M8x1.25 | 12 | 8 | 17 | 2 | — |
| 244-998 | M10x1.25 | 14 | 11.2 | 20 | 2 | — |

Type 2
Serrated Face



Use with `Papco` JIS Metric Flange Bolts or where oversize clearance holes or low compressive strength materials are being bolted. Metric Property Class 9.

245
Series

papco® **BUMPER BAR BOLTS**
BOULONS DE PARE-CHOC

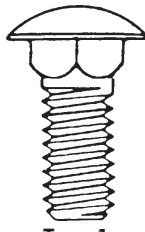

Type 1
Round Head

STAINLESS STEEL CAPPED

'Papco' Bumper Bar Bolts are capped with 18.8 STAINLESS STEEL, carefully polished and buffed to a high lustre. All bolts are Bright Plated to resist rust.



Type 2
Semi-Round Head

Order by Stock Number

Standard Package contains 12 Bumper Bar Bolts and 12 Self-Locking Nuts.
* 6 Bumper Bar Bolts and 6 Self-Locking Nuts.

| Stock No. | Bolt Size | Type | Stock No. | Bolt Size | Type | Stock No. | Bolt Size | Type |
|-----------|-----------------|------|-----------|-----------------|------|-----------|-----------------|------|
| 245-154 | 5/16-18 x 1-1/4 | 1 | 245-171 | 7/16-14 x 1 | 1 | 245-182 | 1/2-13 x 1-1/4 | 1 |
| 245-160 | 3/8-16 x 3/4 | 1 | 245-172 | 7/16-14 x 1-1/4 | 1 | 245-183* | 1/2-13 x 1-1/2 | 1 |
| 245-161 | 3/8-16 x 3/4 | 2 | 245-173 | 7/16-14 x 1-1/2 | 1 | 245-184 | 1/2-13 x 1-3/4 | 1 |
| 245-164 | 3/8-16 x 1 | 1 | 245-174 | 7/16-14 x 1-3/4 | 1 | 245-185 | 1/2-13 x 2 | 1 |
| 245-165 | 3/8-16 x 1 | 2 | 245-175 | 7/16-14 x 2 | 1 | 245-190 | 9/16-12 x 1-1/2 | 1 |
| 245-167 | 3/8-16 x 1-1/4 | 1 | 245-178 | 7/16-14 x 2-3/4 | 1 | | | |
| 245-170 | 7/16-14 x 7/8 | 1 | 245-179 | 7/16-14 x 3-1/2 | 1 | | | |

061
Series

papco® **GRADE B STOVER® LOCKNUTS**
ECROUS A BLOCAGE 'STOVER'®

CADMIUM PLATED
and WAXED

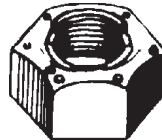

These nuts lock in position when tightened with a wrench.

| Stock No. | Bolt Size | Std. Pkg. | Stock No. | Bolt Size | Std. Pkg. |
|-----------|-----------|-----------|-----------|-----------|-----------|
| 061-016 | 5/16-18 | 100 | 061-020 | 7/16-14 | 50 |
| 061-018 | 3/8-16 | 100 | 061-022 | 1/2-13 | 50 |

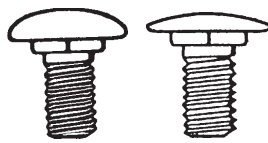

Type 1 Type 2

papco® **METRIC BUMPER BAR BOLTS**
BOULONS DE PARE-CHOC METRIQUE

BUTTON HEAD
BLUE ZINC PLATED

Order by Stock Number

Standard Package 10 Bolts and 10 Metric 'Pozi-Lok' Nuts.

| Stock No. | Bolt Size | Description | Type | Stock No. | Bolt Size | Description | Type |
|-----------|------------------|---------------------|------|-----------|--------------------|------------------|------|
| 245-220 | M8 x 1.25 x 25mm | Chrome Plated Cap | 1 | 245-223 | M8 x 1.25 x 27mm | Uncapped | 2 |
| 245-221 | M8 x 1.25 x 20mm | Uncapped | 1 | 245-233 | M10 x 1.5 x 33.5mm | Stain. Steel Cap | 2 |
| 245-222 | M8 x 1.25 x 28mm | Stainless Steel Cap | 2 | 245-238 | M12 x 1.75 x 35mm | Stain. Steel Cap | 2 |

BUMPER BAR BOLT
MASTER ASSORTMENT No. 020-611

This assortment contains 68 Bumper Bar Bolts and 68 Self-Locking Nuts in 15 sizes selected according to popularity. Packed in a metal box with moulded plastic compartments. Descriptive lid label shows retail price codes. Will service all popular replacement needs including Metric.

Size: 9-3/4" w. x 13-3/4" l. x 2" d.



For Metric 'POZI-LOK' Nuts see page 25.



245
Series

papco

LICENCE PLATE BOLTS BOULONS DE PLAQUE

NOW - Service Stations, Garages, Dealers can turn licence plate installations into a profitable sale. 'Papco' Licence Plate Bolts are made of either heavily electro-plated steel or UV stabilized Nylon.

Order by Stock Number

Standard Package as Indicated

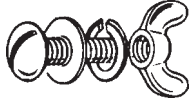

STOCK No. 245-901

Consists of Bolt, Washer, Lock Washer and Wing Nut. Bolt is 1/4-20 x 5/8. Standard Package contains 100 assemblies.



STOCK No. 245-902

Consists of Bolt, Washer, Lock Washer and Square Nut. Bolt is 1/4-20 x 5/8. Standard Package contains 100 assemblies.

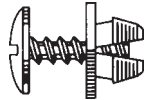

STOCK No. 245-906 UNIVERSAL NYLON LICENCE PLATE NUT with SCREW

Fits all Ford, G.M. and Chrysler products having a 3/8" Square Hole. Assembly consists of a 14 x 5/8" Screw and #14 Square Nylon Nut. Standard Package contains 50 assemblies.



STOCK No. 245-910

No. 14 x 5/8" Special Truss Slot Head, Type 'B' Licence Plate Screw. Electro-plated to resist rust. Standard Package 100 Screws.



STOCK No. 247-840

No. 14 Square Nylon Licence Plate Nut for most domestic and import vehicles. Standard Package contains 25 Nuts.



STOCK No. 213-278

No. 14x3/4 Indented Hexagon Slotted Washer Head Screws. Electro-plated to resist rust. Can be used with 247-840 Nylon Nuts. Standard Package 100 Screws.

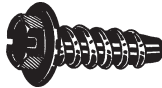

STOCK No. 245-903

For most compact Fords. No. 14x5/8 Indented Hex Slotted Over-size Washer Head Screws. Black Zinc to resist rust. Standard Package 100 Screws. Can be used with 247-840 Nylon Nut.

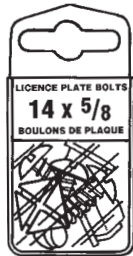

No. 006-109

LICENCE PLATE BOLTS ASSORTMENT No. 020-867

- Each set packed in an attractive hang-up plastic box.
- Set contains 8 pieces -
4 Steel Screws No. 245-910 and
4 Nylon Licence Plate Nuts No. 245-911.
- Screw is heavily plated to resist rust.

Standard Package contains 48 Individual Sets of No. 006-109.

papco NYLON LICENCE PLATE BOLTS

'Papco' Nylon Licence Plate Bolts are made of stabilized Nylon. Self-locking - Can't rust - Long Lasting.

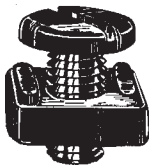

STOCK No. 245-909

Assembly consists of 1/4-20x1/2 Nylon Bolt and a 1/4-20 Self Locking rectangular Nut. Standard Package contains 100 assemblies.

1/4-20x1/2
245-909

STOCK No. 245-908

Assembly consists of M6x20 Nylon Bolt and a M6 Nylon Hex Nut. Standard package contains 100 assemblies.

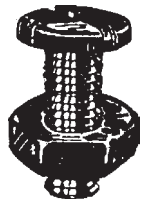

M6x20mm
245-908

246
Series

papco

**MOULDING BOLTS
BOULONS DE MOULURE**



Order by Stock Number

Illustrations Actual Size

Standard Packages 25 Pieces
*Standard Packages 50 Pieces

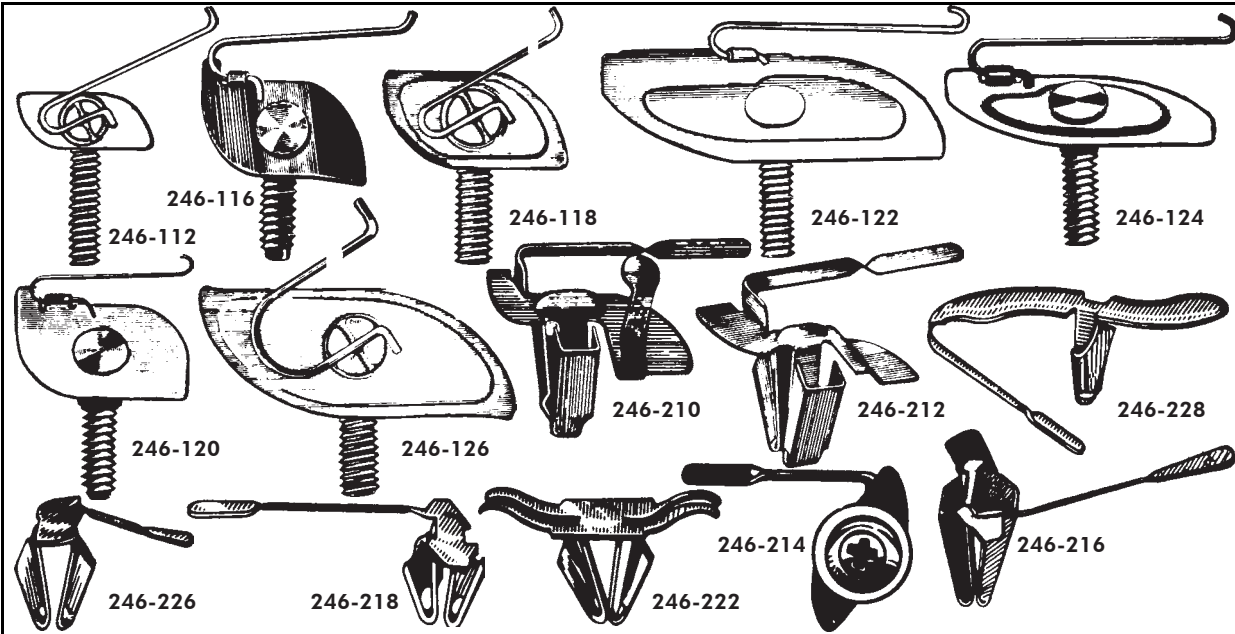

| Stock No. | Factory No. | Application |
|-----------|------------------------------------|---|
| 246-112* | 6010093, 1624705 | Universal 'T' Bolt Clip 10-24x3/4" |
| 246-116* | 3792051 | Chevrolet Front Fender 10-24x5/8" |
| 246-118* | 1165051 | Chevrolet and Olds Front and Rear Fender 12-24x5/8" |
| 246-120* | 10-24x1/2 Universal | Universal 'T' Bolt Clip |
| 246-122* | 1758099, 6000720, 6010046, 3744999 | Universal 'T' Bolt Clip 10-24x1/2 |
| 246-124* | 3722635, 6013029, 6000705 | Universal 'T' Bolt Clip 10-24x3/4 |
| 246-126* | 4730773, 4637277 | Universal 'T' Bolt Clip 12-24x3/4 |
| 246-210 | 4759145, 4761842, 4779348 | GM Front and Rear Fender and Door Peak - All |
| 246-212 | 3944866 | GM General Purpose |
| 246-214 | 9645350 | GM Door and Door Belt |
| 246-216 | 1484570 | GM General Purpose |
| 246-218 | 1484569, 6002356 | General Purpose Belt Moulding |
| 246-222 | D5AB-60423B06-AA, D5DB-66423B06-CA | Ford Moulding |
| 246-226 | D5DB-66423-B06 | Ford Belt Moulding |
| 246-228 | D8KB-5420908AA, 4003695 | Ford Moulding |

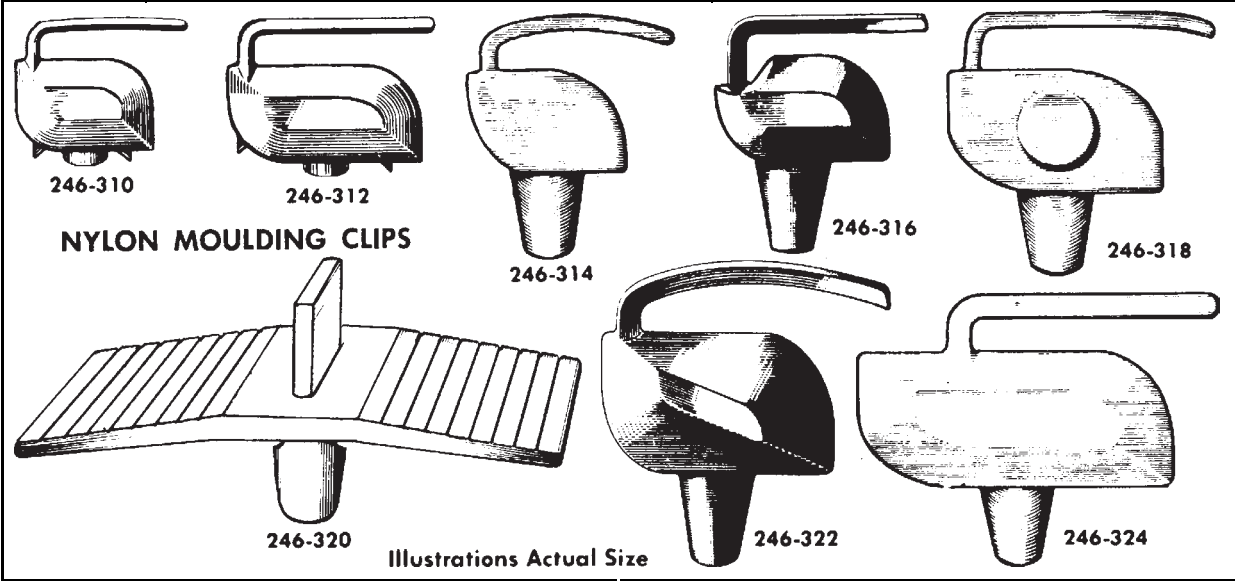

Illustrations Actual Size

| Stock No. | Factory No. | Application | Stock No. | Factory No. | Application |
|-----------|------------------|---------------------------|-----------|-------------|----------------------------------|
| 246-310 | 4886720, 4417599 | GM Front and Rear Fenders | 246-318 | 4883164 | Rear Fender Lower Moulding |
| 246-312 | 4879481 | GM Front and Rear Door | 246-320 | Universal | Nylon Push-in Type fits 3/8 hole |
| 246-314 | 4853108 | GM Front and Rear Door | 246-322 | 4877001 | Rear Fender Lower Moulding |
| 246-316 | 4877000 | GM Door and Fender | 246-324 | Universal | Rat-Tail Type |

For 'Papco' Moulding Bolt Super-Service Assortment No. 020-822 see page 9.



246
Series

papeco MOULDING CLIPS
PINCES DE MOULURE

Order by Stock Number

Illustrations Actual Size

Standard Package 25 pieces (* 100 pieces)

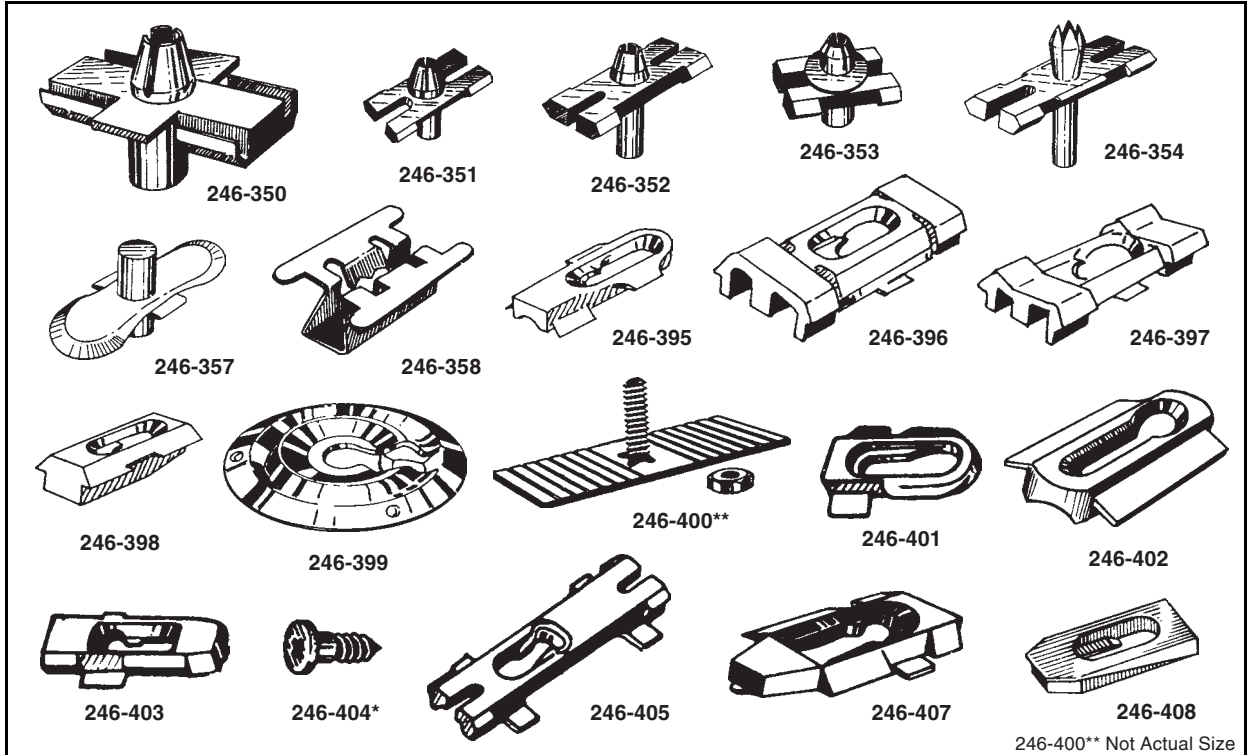

| Stock No. | Factory No. | Application |
|-----------|-------------------------------------|--|
| 246-350 | 1201-930 | Volvo Side Moulding Clip Black |
| 246-351 | 803-853-139C | VW Moulding Clip Red |
| 246-352 | 825-853-139 | Audi Moulding Clip |
| 246-353 | 5113-1-804-205 | BMW Moulding Clip With Sealer |
| 246-354 | 1202-997 | Volvo Moulding Clip Green |
| 246-357 | 1-247-708 | Volvo Side Moulding |
| 246-358 | 90183-03001 | Toyota Front Bumper, Cushion Clip |
| 246-395 | 8799350 | GM Rear End and Quarter Panel Moulding |
| 246-396 | 20175051 | GM Quarter Belt Reveal Moulding |
| 246-397 | 20199675 | GM Quarter Belt Reveal Moulding |
| 246-398 | 1688094 | GM Vinyl Top Moulding |
| 246-399 | 3986976 | GM Rocker Panel Moulding - Metal |
| 246-400 | 10-24x3/4 Universal | Scored Type Moulding Bolt fits up to 2 1/2" wide |
| 246-401 | 9838109 | GM Body Side Moulding |
| 246-402 | 4492962 | GM Body Side and Wheel Opening Moulding |
| 246-403 | D1MY 65402488 | Ford Roof Cover and Body Side Mouldings |
| 246-404* | 4-24x3/8 Special Phillips Flat Head | Screw (replaces Welded Studs) |
| 246-405 | 6003133 | Chrysler Door and Fender |
| 246-407 | DSAZ-7120818-A | Ford Door, Quarter Panel and Roof Moulding |
| 246-408 | 9727078 | GM Belt Moulding |

246-400** Not Actual Size

246
Series

papeco WINDOW REGULATOR RIVETS
RIVET REGULATEUR DE FENETRE

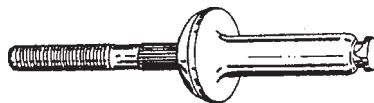

Aluminum Body/ Steel Mandrel

Order by Stock Number

Standard Packages 25 pieces

| Stock No. | Factory No. | Dia. | Flange | Max Grip | Application |
|-----------|-------------------------------|------|--------|----------|---|
| 246-600 | 9436175, 385189-S100, 6031115 | 1/4 | 1/2 | 9/64" | GM, Ford, Chry, Window Regulator |
| 246-605 | 20184399, 389268-S100 | 1/4 | 1/2 | 3/4" | GM, Ford, Window Regulator |
| 246-610 | 385323-S100, 6031091 | 1/4 | 1/2 | 19/32" | Ford, Chrysler, GM Window Regulator |
| 246-612 | 388047-S100 | 1/4 | 1/2 | 1/8" | Ford Door Handle Assembly, GM Heat Shield Attach. |

For Moulding Clip Master Assortment No. 020-684 see page 8.



Order by Stock Number

Illustrations Actual Size

Standard Packages 25 pieces (* 10 pieces)

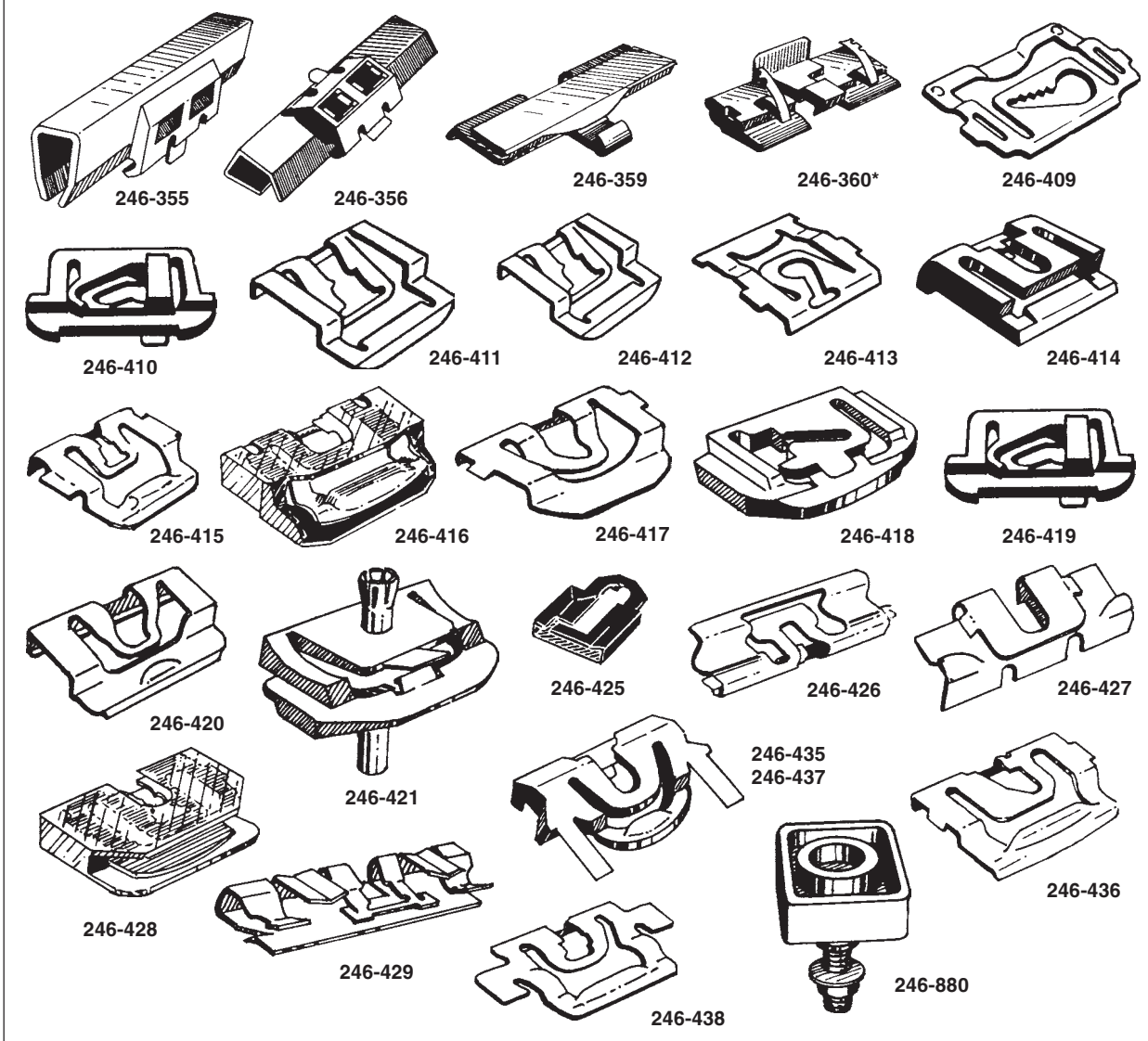

| Stock No. | Factory No. | Application |
|-----------|---------------------------------|---|
| 246-355 | 1-246-926 | Volvo Windshield Moulding Grey |
| 246-356 | 1-255-553 | Volvo Windshield Moulding White |
| 246-359 | 75546-32010, 75548-32010 | Toyota Windshield Moulding with Adhesive Pad |
| 246-360* | 90674-692-0030 | Honda Windshield Moulding with Adhesive Pad |
| 246-409 | 9895598 | GM Windshield Reveal Moulding |
| 246-410 | 1654047 (Nylon) | GM Windshield and Rear Window Reveal Moulding |
| 246-411 | 8717859, 9854717 | GM Rear Window Reveal Moulding |
| 246-412 | C8AZ-63642413-A, D1AZ-6542413-B | Ford Rear Window and Windshield Moulding |
| 246-413 | 6003049 | Chrysler Windshield and Rear Window Reveal Moulding |
| 246-414 | D9AZ-5403178-A (Nylon) | Ford Windshield Top Reveal Moulding |
| 246-415 | E3SB-6342413-AB | Ford Windshield and Backlite Moulding |
| 246-416 | 6003878 (Nylon/Metal) | Chrysler Windshield Backlite Moulding |
| 246-417 | 9662950 | GM Windshield and Rear Window Reveal Moulding |
| 246-418 | 9731301 (Nylon) | GM Windshield to Panel Lower Side |
| 246-419 | 20169887 (Nylon) | GM Windshield Reveal Moulding |
| 246-420 | 9808241 | GM Windshield and Rear Window Reveal Moulding |
| 246-421 | 20113224 (Nylon) | GM Reveal Windshield Lower Moulding |
| 246-425 | 4234830 | GM Door Lock Rod Clip |
| 246-426 | E4ZB-6142413-AA | Ford Backglass Moulding |
| 246-427 | D8VZ-6003166-A (Nylon/Metal) | Ford Windshield and Rear Glass Reveal Moulding |
| 246-428 | E2ZB-6142413-AA | Ford Windshield Backlite Moulding |
| 246-429 | E7SZ-6342413-A | Ford Backglass Moulding |
| 246-435 | 6003755 (Nylon) | Chrysler Windshield and Backlite Reveal Moulding |
| 246-436 | 6003752 | Chrysler Windshield and Backlite Reveal Moulding |
| 246-437 | 6003755 (Nylon) | Chrysler Windshield and Backlite Reveal Moulding |
| 246-438 | 6003426 | Chrysler Window Reveal Moulding |
| 246-880 | D6AZ-5323240-A | Ford Roller and Nut Window Guide |

For Windshield Clip Master Assortment No. 020-681 see page 8.



246
Series

papco GLASS SHOP FASTENERS
ATTACHES A PARE-BRISE

'Papco' Window Channel Guides are used to repair loose or dislodged door windows when original guides break. Fold-over, snap-on guides are attached to edge of window glass to maintain alignment in door channels.

Order by Stock Number

Illustrations Not Actual Size

Standard Packages 25 pieces

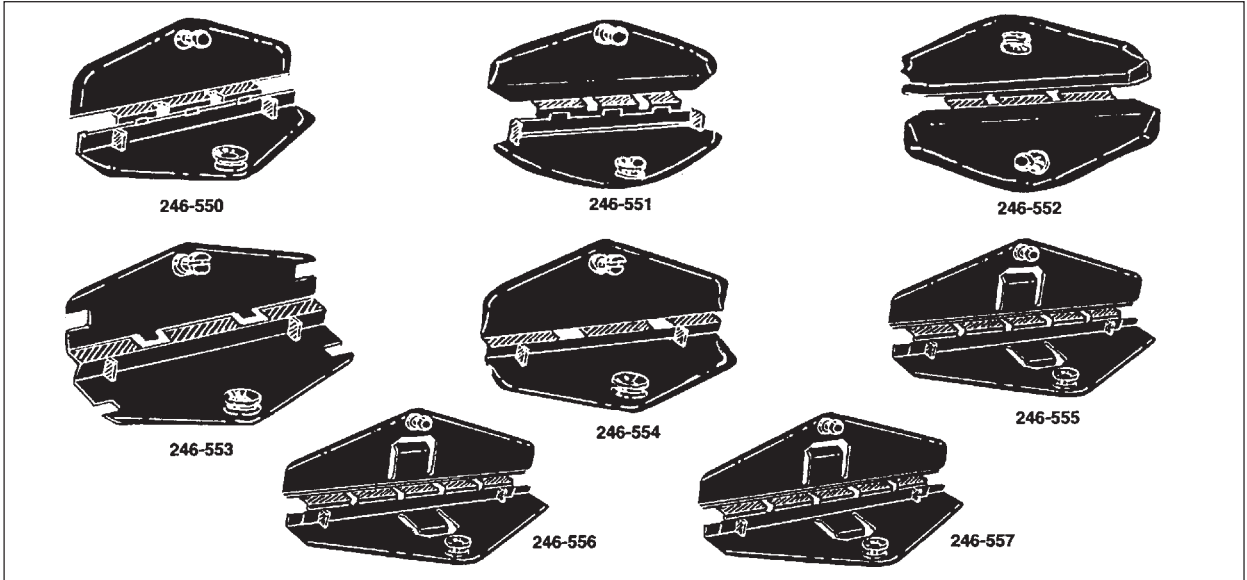

| Stock No. | Factory Number | Application |
|-----------|------------------------------|---|
| 246-550 | 20162174, 22543363 | GM Front Door Window Guide "J" Bodies |
| 246-551 | 20747509 | GM Front Door Window Guide "C" and "H" Bodies |
| 246-552 | 20478733, 22539533 | GM Front Door Window Guide Rear Olds, Buick "C" Bodies |
| 246-553 | 10051034, 20123070, 20328600 | GM Front Door Window Guide "B" "C" and "X" Bodies |
| 246-554 | 20160591 | GM Rear Door Window Guide Wagons, "B", "C" and "X" Bodies |
| 246-555 | 20747508, 20487631 | GM Front Door Window Guide "C" Bodies |
| 246-556 | 12353912, 20487630, 20712176 | GM Front Door Window Guide Olds, Buick "C" Bodies |
| 246-557 | 10051034, 10114597, 12338011 | GM Front Door Window Guide "A" Bodies, "S" Trucks |



WINDSHIELD MOULDING RELEASE TOOL
OUTIL POUR ENLEVER MOULURES DE PARE-BRISE
No. 246-500

For removing all windshield mouldings. Features angled shaft and bevelled front edges for easy entry. Individually carded.

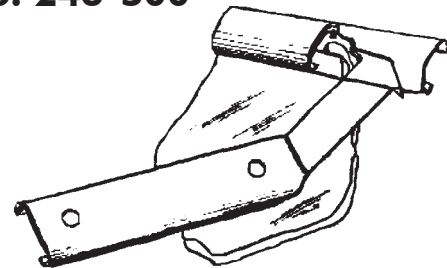

WINDOW HANDLE REMOVING TOOL
OUTIL DEMONTE-MANIVELLE
No. 246-895

For removing clips inside door and window handles. Raised end can be used to remove door panels. Individually carded.

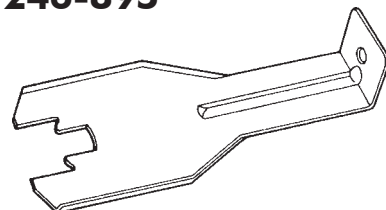



The flexible ribs of these nylon fasteners deflect as the clip is pushed into a panel hole and hold securely anywhere along their ribbed shank. The Cut-Out-Type can be twisted into a small panel hole for retention. Used on inner door panels to hold covering or trim.

Order by Stock Number Illustrations Actual Size Standard Package 25 pieces

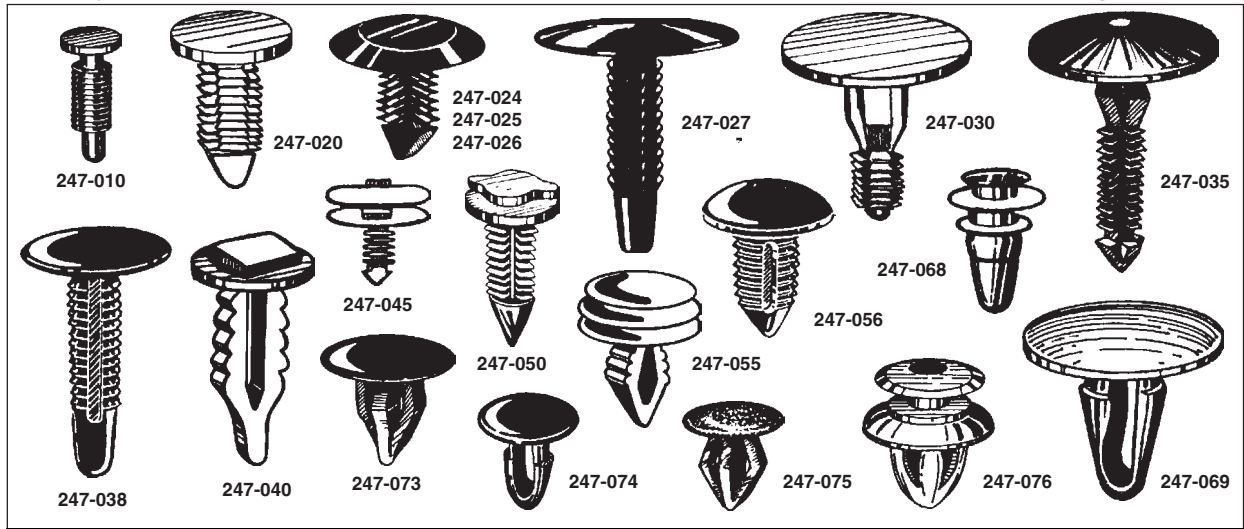

| Stock No. | Factory No. | Application | Stock No. | Factory No. | Application |
|-----------|-------------------|--------------------------------|-----------|-----------------------|--------------------------------|
| 247-010 | 411700 | GM - Trim Panel Retainer | 247-045 | 6003654 | Chrysler - Door & Bumper Trim |
| 247-020 | 25514222, 6003587 | GM, Chrysler - Roof Headliner | 247-050 | 20298365, 6013122 | GM, Chrysler - Trim Panel Ret. |
| 247-024 | 389443-S | Ford - Fascia To Bumper | 247-055 | 387477-S | Ford - Interior Trim Panel |
| 247-025 | 385661-S, 6003349 | Ford, Chrysler - Trim Panel | 247-056 | 22512276 | GM - Panel Retainer |
| 247-026 | 2048248, 6003423 | GM, Chrysler - Int. Trim Panel | 247-068 | 95005064, 67771-01010 | GM, Toyota - Door Trim Panel |
| 247-027 | 388930-S | Ford - Trim Panel Retainer | 247-069 | 90467-09008 | Toyota - Retaining Clip |
| 247-030 | D6NW9452-118-A | Ford - Roof Trim | 247-073 | 38529-689A-6300 | Honda - Retaining Clip |
| 247-035 | N-800387-S | Ford - Dashboard | 247-074 | 90467-06161-01 | Toyota - Retaining Clip |
| 247-038 | 389443-S | Ford - Trim Panel Retainer | 247-075 | 76906-T3000 | Nissan - Retaining Clip |
| 247-040 | 20036949 | GM - Trim Panel Retainer | 247-076 | 680-097 | Volvo - Moulding Retainer |

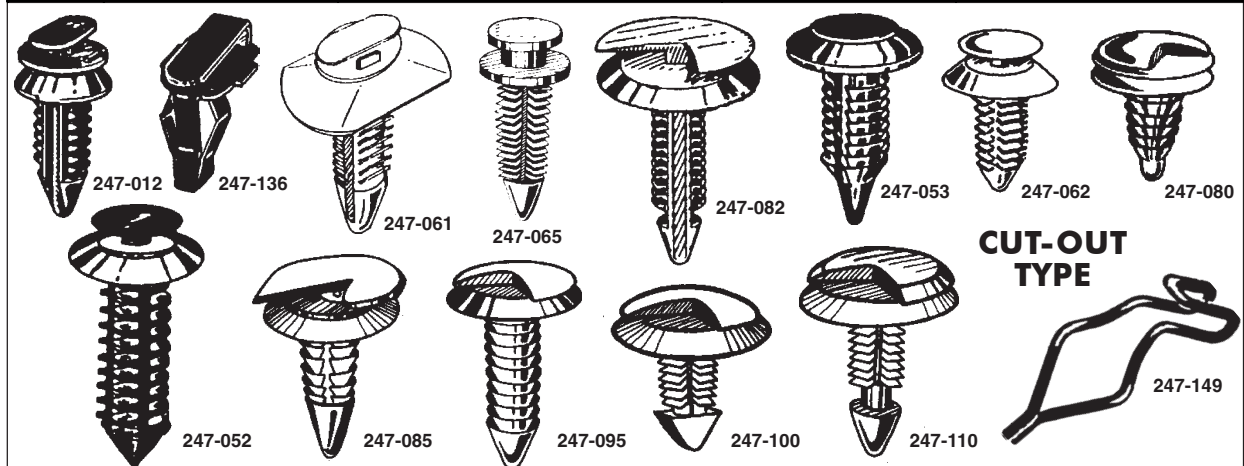

| Stock No. | Factory No. | Application | Stock No. | Factory No. | Application |
|-----------|------------------------|--------------------------------|-----------|------------------|----------------------------------|
| 247-012 | 15545202 | GM - Door Trim Panel | 247-082 | 10126901 | GM - Trim Panel |
| 247-052 | N805612-S100 | Ford, GM, Jeep Eagle, | 249-085 | 3065575 | GM - Door Trim Panel |
| | 10143422, 8934-202-599 | Door Trim Panel | 247-095 | 363137 | Chev. Truck, GMC - Trim Panel |
| 247-053 | N805155-S | Ford - Door Trim Panel | 247-100 | 9685057, 6003349 | GM, Chrysler, VW - Door Trim Pl. |
| 247-061 | 20421800, 15600382 | GM - Door Trim Panel | 247-110 | 387496-S | Ford - Trim Panel Retainer |
| 247-062 | N801925-S | Ford - Door Trim Panel | 247-136 | 4114785 | Chrysler - Trim Panel |
| 247-065 | 387182-S | Ford - Seat Back | 247-149 | 383033-S101 | Ford - Door Trim Panel |
| 247-080 | 2064891, 9883583 | GM - Door Trim Pl. & Headliner | | | |

For Trim Fastener Master Assortments No. 020-679, 680 and 682 see page 8.



247
Series

papeo PLASTIC SHIELD RETAINERS
RETENUES DE PROTEGER PLASTIQUE

Order by Stock Number

Illustrations Actual Size

Standard Packages 25 pieces (* 5 pieces)

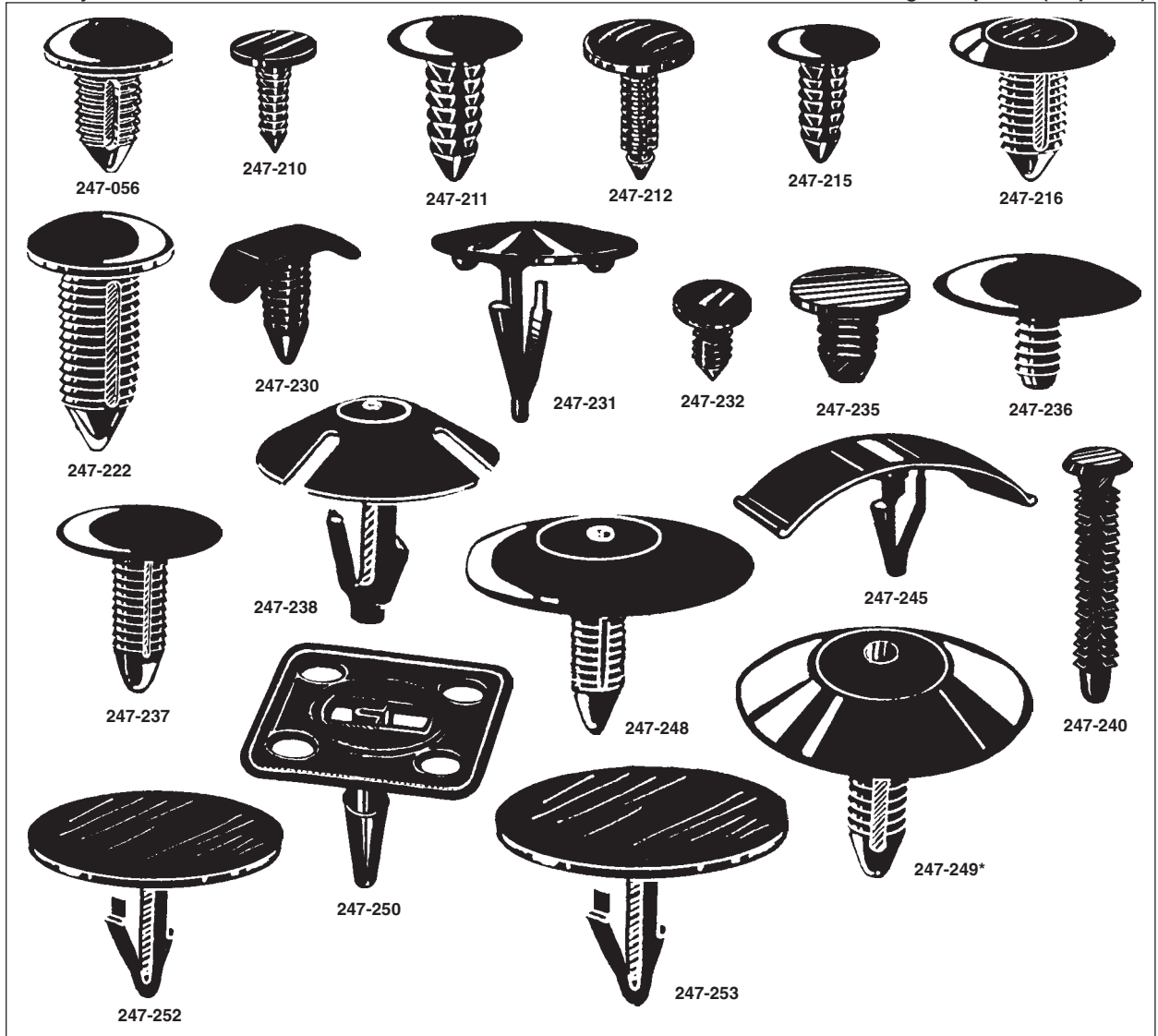

| Stock No. | Factory No. | Application | Stock No. | Factory No. | Application |
|-----------|--------------------|-------------------------------|-----------|-------------------|----------------------------|
| 247-056 | 22512276 | GM Front End Stone Shield | 247-236 | 2998430 | Chrysler, Radiator Grille |
| 247-210 | 25016383 | GM Dash Panel | 247-237 | 6501067 | Chrysler Fascia |
| 247-211 | 1605396, 388577S | GM, Ford, Chrysler, Radiator | 247-238 | 4341060 | Chrysler Hood Insulated |
| 247-212 | 20514862 | GM Screen Shroud | 247-240 | N-800505-S | Ford Radiator Attaching |
| 247-215 | 332364, 359358, | GM, Ford, Chrysler Fender | 247-245 | 385330-S, 6003351 | Ford Grille, Chrysler Hood |
| 247-216 | 1619321 | GM Radiator Apron | 247-248 | 20064875 | GM Hood Insulation |
| 247-222 | 1631564, N804379-S | GM, Ford Bumper | 247-249* | 3078511, 3977775 | GM Hood Insulation |
| 247-230 | 480534, 384051-S | GM, Ford, Cowl Insulation | 247-250 | 389809 | GM Hood Insulation |
| 247-231 | 385595-S | Ford Hood Insulation | 247-252 | 386553-S | Ford Hood Insulation |
| 247-232 | N803170-S | Ford Fascia | 247-253 | 388908-S | Ford Hood Insulation |
| 247-235 | 20032850, 387258-S | GM, Ford, Chrysler Mud Shield | | | |

For Trim and Weatherstrip Super-Service Assortment No. 020-813 see page 9.

TRIM PAD RELEASE TOOL No. 247-299



Made of heat-treated, high carbon steel with beveled front edges for easy insertion - plus a machined gripping slot for positive contact. Designed to remove plastic trim pad fasteners without damaging the fastener or backboard. Works well on metal trim pad fasteners. Individually carded.

247
Series



WEATHERSTRIP FASTENERS
ATTACHES POUR BANDE METEOROLOGIQUE



Order by Stock Number

Illustrations Actual Size

Standard Packages 25 pieces

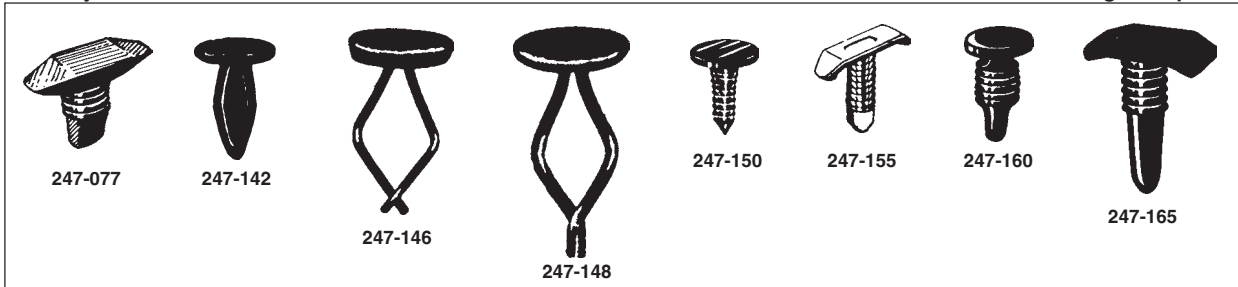

| Stock No. | Factory No. | Application | Stock No. | Factory No. | Application |
|-----------|----------------|-----------------------------------|-----------|----------------|-------------------------------|
| 247-077 | 90664-671-0030 | Honda Weatherstrip Fits 5mm Hole | 247-150 | 8731909 | GM Door Weatherstrip |
| 247-142 | 4801268 | GM Door Flange Weatherstrip | 247-155 | 4876498 | GM Door and Body Weatherstrip |
| 247-146 | Universal | (Brow n) Button Head Weatherstrip | 247-160 | 2964547 | Chrysler Weatherstrip |
| 247-148 | Universal | (Brow n) Button Head Weatherstrip | 247-165 | C5AB-6220586-A | Ford Door Weatherstrip |

247
Series



ANCHOR GROMMETS
MANCHONS L'ANCRE

These plastic, self-retained grommets snap into panel holes. The Spacer Type are used as secure mounting posts or bezels. The Bathtub Type accommodate alignment variations.

Order by Stock Number

Illustrations Actual Size

Standard Packages 25 pieces

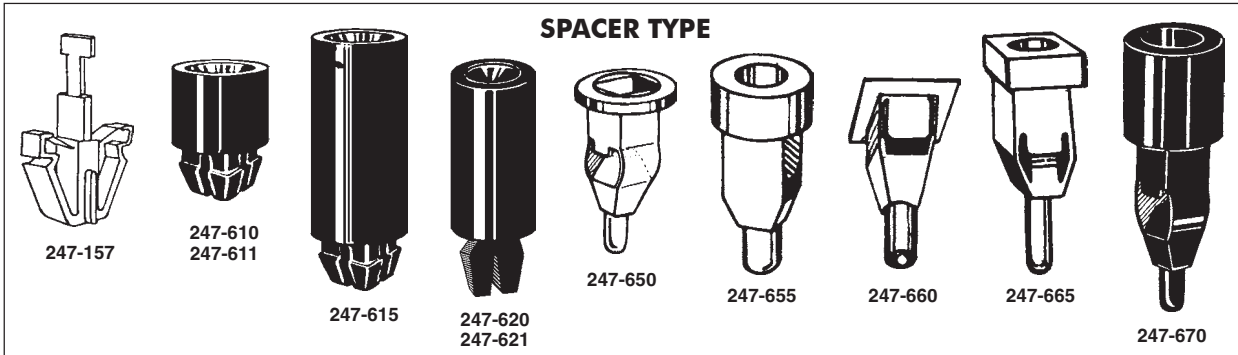

| Stock No. | Factory No. | Application | Stock No. | Factory No. | Application |
|-----------|-------------|--|-----------|-------------|---|
| 247-157 | — | Chrysler, Ford, GM, Honda Grille Clip 13mm wide, 22mm long, fits 9mm hole | 247-620 | 3863669 | GM No. 8 - 10 Thread - 1 1/4" Long Radiator Grille to Headlamp |
| 247-610 | 0152862 | Chrysler No. 8 Thread - 3/8" Long Windshield Spacer | 247-621 | 6027012 | Chrysler Headlamp Bezel (Ext. Nut) |
| 247-611 | 0152863 | Chrysler No. 8 Thread - 1/2" Long Rea Window Garnish Moulding Nut | 247-650 | 7746629 | GM Headlamp Dr. Spacer Nut |
| 247-615 | 0152867 | Chrysler No. 8 Thread 1" Long Headlamp Spacer | 247-655 | 411847 | Oldsmobile Headlamp Door Nut |
| | | | 247-660 | — | GM Front Lamp Side Marker Att. Toggle |
| | | | 247-665 | 562638 | Oldsmobile No. 8 Thread Headlight Door to Fender Nut (Black) |
| | | | 247-670 | — | GM Headlamp Door Spacer |

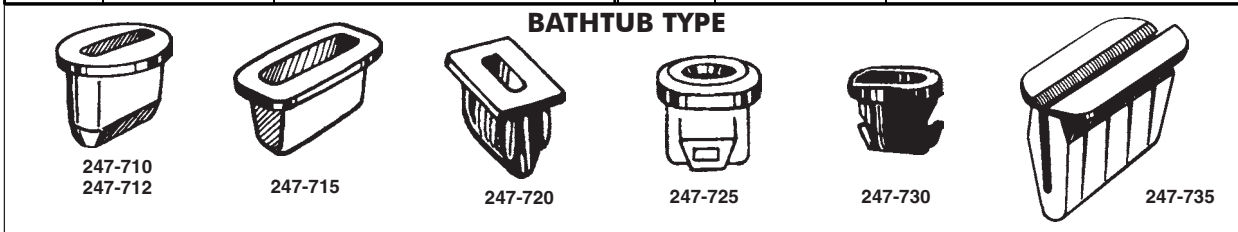

| Stock No. | Factory No. | Application | Stock No. | Factory No. | Application |
|-----------|-------------|-------------------------------------|-----------|-------------|-------------------------------------|
| 247-710 | — | GM Headlamp Bezel Nut | 247-725 | 6031234 | Chrysler Radiator Grill #8 Screw |
| 247-712 | 14032291 | GM #6 or #8 Screw Grille Attachment | 247-730 | N-800503-S | Ford Grille Attachment Nut #6 Screw |
| 247-715 | 3986978 | GM General Purpose | 247-735 | 10032838 | GM, Chrysler |
| 247-720 | 1255823 | GM Front End Bezel Nut | | 1264963 | (High Torque Screw Grommet) |
| | 389360S | Ford Tail Light Nut | | 6031869 | |



247
Series

papeo ANCHOR NUTS and CLIPS
ECROUS L'ANCRE et PINCES

* 50 Pcs.
** 10 Pcs.
• 5 Pcs.

Order by Stock Number

Illustrations Actual Size

Standard Packages 25 Pcs.

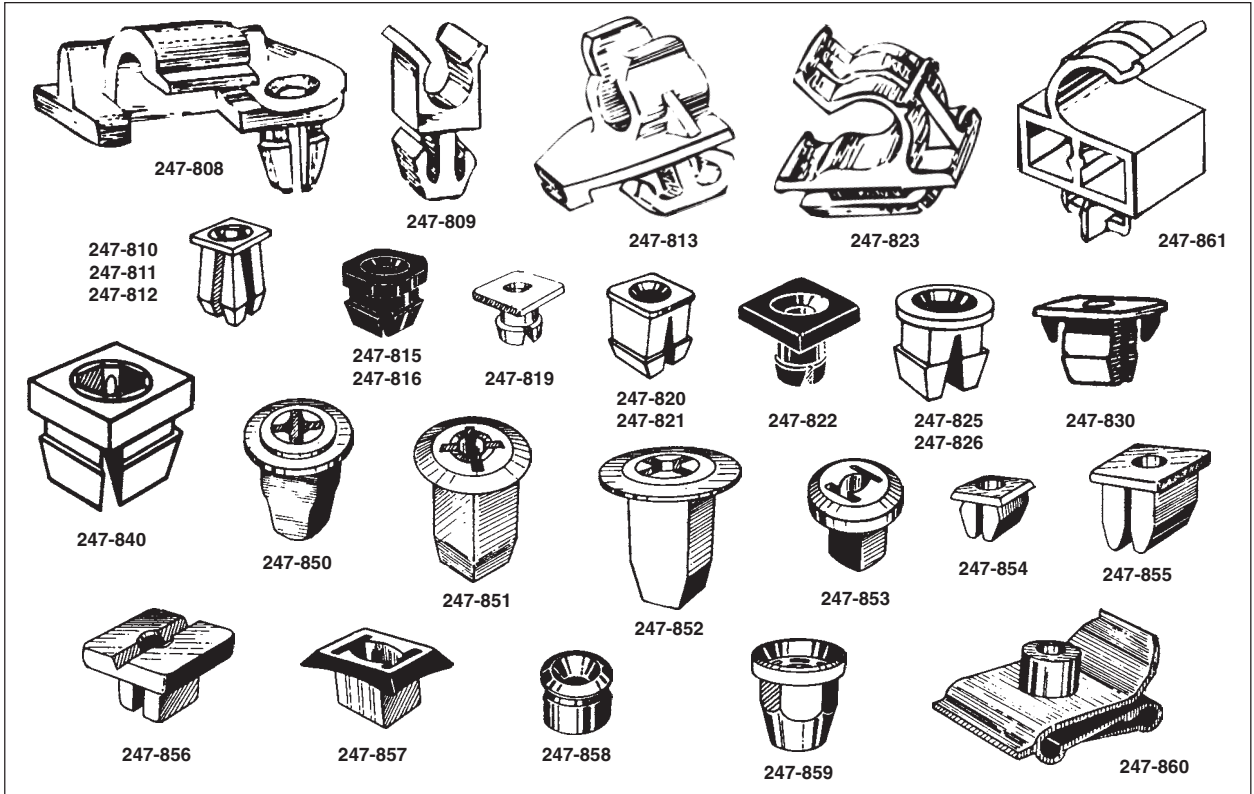

| Stock No. | Factory No. | Application | Stock No. | Factory No. | Application |
|-----------|-----------------|---------------------------------------|-------------|------------------|-----------------------------------|
| 247-808 • | D5ZZ-16828A | Ford Hood Prop Rod Clip | 247-850 | 90672-671-8110M1 | Honda No. 6 Screw Grommet |
| 247-809 • | 386299-S | Ford Hood Prop Rod Clip | 90189-04013 | | Toyota |
| 247-810 | 379830-S | Ford Headlight Door No. 8 or 10 Screw | 247-851 | 90661-SC7-0030 | Honda No. 8 Screw Grommet |
| 247-811 | 1254815 | GM General Purpose No. 6 Screw | H001-50-841 | | Mazda |
| 247-812 | 9669486 | GM Side Marker No. 8 Screw | 01651-00481 | | Nissan |
| 247-813 • | 14003756 | GM Hood Prop Rod Clip | 247-852 | 01281-00023 | Nissan No. 10 Screw Grommet |
| 247-815 | 3893980 (Black) | GM Grille to Front End No. 8 Screw | 90189-06001 | | Toyota |
| 247-816 | 3919773 | GM Headlamp Bezel No. 8 Screw | 247-853 | 90662-693-0030 | Honda No. 6 Screw Grommet |
| 247-819 | 14013246 | GM No. 8 Screw | 247-854 | 90655-SA0-0030 | Honda No. 6 Screw Grommet |
| 247-820 | 380382 | GM Headlight Bezel No. 6 or 8 Screw | 247-855 | 90189-05013 | Toyota No. 10 Screw Grommet |
| 247-821 | 6000943 | Chrysler Radiator Grille No. 8 Screw | 247-856 | 90662-671-0030 | Honda No. 10 Screw Grommet |
| 247-822 | 6500725 (Black) | Chrysler Headlamp Bezel No. 10 Screw | | 9991-00-503 | Mazda |
| 247-823 • | 4103276 | Chrysler Hood Prop Rod Clip | | 68425-H50000 | Nissan |
| 247-825 | 2524525 | Chrysler No. 8 or 10 Screw | 247-857 | 90668-688-0030 | Honda #6 Screw Grommet w/sealer |
| 247-826 | 1355003 | GM Headlight Door No.6 or 8 Screw | 247-858 * | 000-988-15-81 | Mercedes Benz Moulding Insert Red |
| 247-830 | 6030301 | GM Headlight Bezel No. 6 or 8 Screw | 247-859 | 4133-5-480-120 | BMW Plastic Nut 4mm Thread |
| 247-840 | 4755299 | Licence Plate Nut No. 14 Screw | 247-860** | 53879-14010-A | Toyota "U" Nut No. 10 Screw |
| | | | 247-861 • | 90677-671-0031 | Honda Holds 8mm Prop Rod |

ANCHOR GROMMETS and NUTS
MASTER ASSORTMENT
No. 020-678

Contains 295 Anchor Grommets and Nuts. Packed in a metal container with high-strength plastic compartments.

ANCHOR NUTS
UTILITY ASSORTMENT
No. 020-358

Contains 150 Nuts of 247-810, to 247-840. Complete Coverage.

'PLASTI-RIVET'
UTILITY ASSORTMENT
No. 020-357

Contains 130 Rivets of 247-410, 415, 420, 450, 455, 460, 465, 470, 475, 480, 485.

Both assortments packed in a sturdy fibreboard container with actual size illustrations on label.

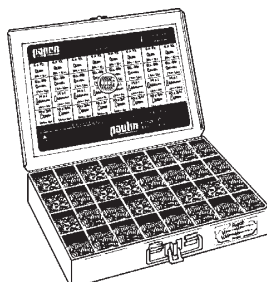

papeo SUPER SERVICE ASSORTMENT No. 020-814

Contains 465 Anchor Grommets and Nuts - 32 items.

Large size, rigid metal box with high-strength plastic compartments.

For more details see page 9.

Large size: 12" w. x 18" l. x 3" d.

247
Series

papeo **SCREW-IN RETAINERS**
ATTACHE DE SOUTIEN AVEC VIS



Order by Stock Number

Illustrations Actual Size

Standard Packages 25 pieces

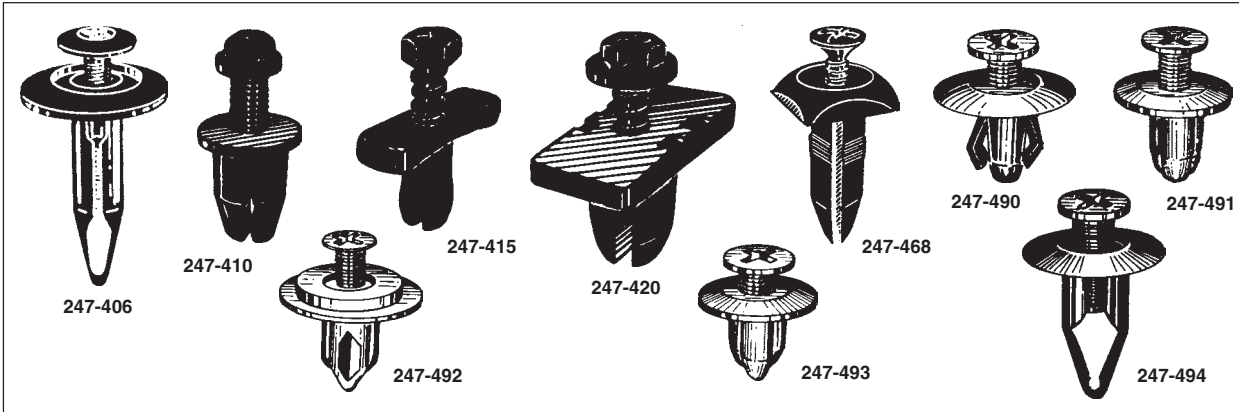

| Stock No. | Factory No. | Application | Stock No. | Factory No. | Application |
|-----------|-------------|--|-----------|----------------|-----------------------|
| 247-406 | N804570-S | Ford Trim Retainer | 247-490 | 90675-SB3-003 | Honda Screw Retainer |
| | 20664092 | GM Exterior Body | | FB01-56-964 | Mazda |
| 247-410 | 22500586 | GM Radiator Shroud Retainer | | 63876-95596 | Nissan |
| 247-415 | 14013241 | GM Grille Mounting and General Purpose | 247-491 | 90684-SA5-0030 | Honda Screw Retainer |
| 247-420 | 14017689 | GM Grille Rack and Signal Light | | 10998-30880 | Nissan |
| 247-468 | N803494-S | Ford Aerostar Fascia, Trim and Grille | 247-492 | 90668-SB0-0030 | Honda Screw Retainer |
| | 15679091 | GM Blazer and Jimmy Door Handle Bezel | 247-493 | 90467-06017-20 | Toyota Screw Retainer |
| | | | 247-494 | 63844-01A00 | Nissan Screw Retainer |

247
Series



'PLASTIC-RIVETS'
'RIVETS-PLASTIQUE'

Order by Stock Number

Illustrations Actual Size

Standard Package 25 Pieces (*15 pieces)

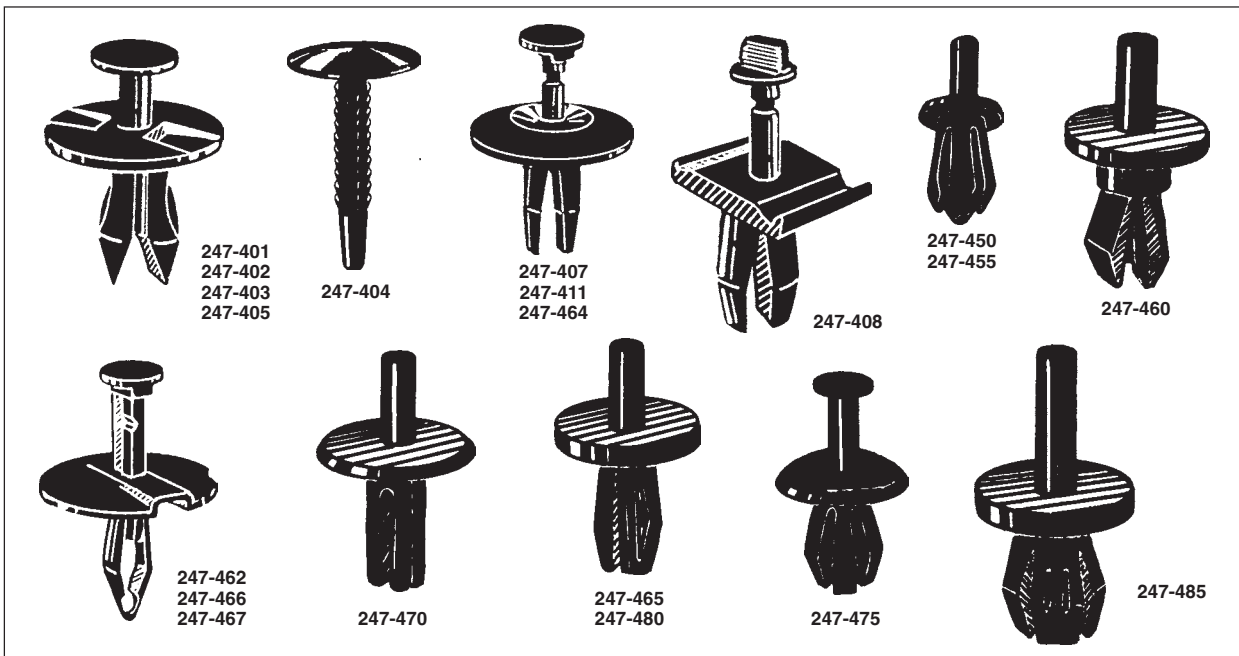

| Stock No. | Factory No. | Application | Stock No. | Factory No. | Application |
|-----------|-------------|------------------------------|-----------|-------------|---|
| 247-401* | 5973400 | GM Fascia | 247-460 | 387944-S | Ford Grille to Metal Stamping |
| 247-402 | 5973823 | GM Fascia (Blue) | 247-462 | N802781-S | Ford, GM Splash Shield and Fascia |
| 247-403 | 5973996 | GM Body (Brown) | 247-464 | N805231-S | Ford Grille Opening Reinforcement |
| 247-404 | 20590899 | GM Exterior Body | 247-465 | 387843-S | Ford Fender Shield |
| 247-405 | 14045480 | GM Fascia | 247-466 | N803362-S | Ford, GM Body |
| 247-407 | 14019206 | GM Fender Liner | | 20510029 | |
| 247-408 | 14032200 | GM Grille Attachment | 247-467 | 6501590 | Chrysler, Ford Splash Shield and Fascia |
| 247-411 | 14019226 | GM Rad Overflow and | 247-470 | 383142-S | Ford Grille to Headlamp Bracket |
| | 14071289 | Windshield Washer Reservoir | 247-475 | 6031383 | Chrysler Grille |
| 247-450 | 14005089 | GM A/C Vents General Purpose | 247-480 | 6031390 | Chrysler Plastic Inner Fender |
| 247-455 | 10017619 | GM Front Bumper Grille Bar | 247-485 | 6031548 | Chrysler Bumper Strip |



248
Series



HEADLAMP ADJUSTING SCREWS VIS DE PHARES REGLAGE

Order by Stock Number

Illustrations Actual Size

Standard Packages 10 pieces

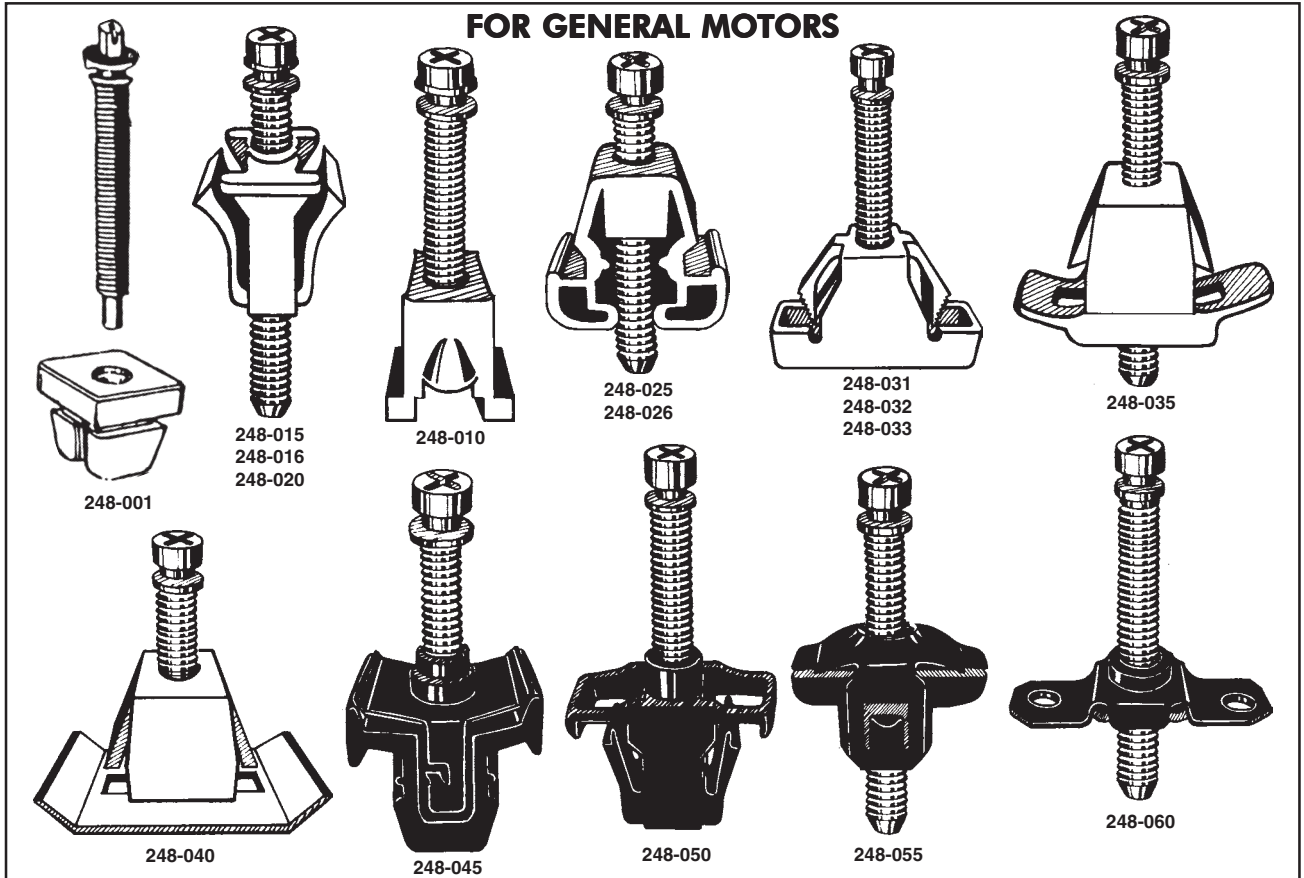

| Stock No. | Factory No. | Application | Screw Dia. x Length |
|-----------|--------------------|---|---------------------|
| 248-001 | 3921446 (nut) | GM Headlamp Adjusting Screw and Nut | 1/4-28x1-1/2" |
| 248-010 | — | Chevrolet All Early Models (White Nut) | 1/4-28x1-1/2" |
| 248-015 | 354076, 343543 | Chevrolet, Buick (White Nut) | 1/4-28x2" |
| 248-016 | 365270 | GM Fiberglass Panels (Green Nut) | 1/4-28x2" |
| 248-020 | 365266 | Chevrolet Fiberglass Panels (Green Nut) | 1/4-28x2" |
| 248-025 | 1606642, SF4006204 | Olds, Cadillac, AMC (Pink Nut) | 1/4-28x1-7/8" |
| 248-026 | 1600375 | Cadillac (Pink Nut) | 1/4-28x1-1/2" |
| 248-031 | 556539 | Buick, Olds (Black Nut) | 12-28x1-3/8" |
| 248-032 | 556196 | Buick, Olds (White Nut) | 12-28x1-3/8" |
| 248-033 | 557057 | GM (Blue Nut) | 12-28x1-3/4" |
| 248-035 | 553799 | Buick, Olds | 1/4-28x1-3/8" |
| 248-040 | 413852 | Oldsmobile | 1/4-28x1" |
| 248-045 | 1493541 | Buick, Cadillac, Pontiac | 1/4-28x1-1/2" |
| 248-050 | 500267 | Chevrolet, Pontiac | 1/4-28x1-5/8" |
| 248-055 | 1235816 | Buick, Cadillac | 1/4-28x1-1/2" |
| 248-060 | — | GM | 1/4-28x1-5/8" |

MASTER ASSORTMENT No. 020-675

For General Motors

Contains 50 Headlamp Adjusting Screws and Nuts for General Motors. Packed in a metal box with high-strength plastic compartments complete with actual size illustrations and retail price codes on a grease-resistant lid label.



MASTER ASSORTMENT No. 020-676

For Ford and Chrysler

Contains 50 Headlamp Adjusting Screws and Nuts for Ford and Chrysler Products. Packed in a metal container with moulded, plastic compartments. Actual size illustrations and retail codes shown on lid label.



Order by Stock Number

Illustrations Actual Size

Standard Packages 10 pieces

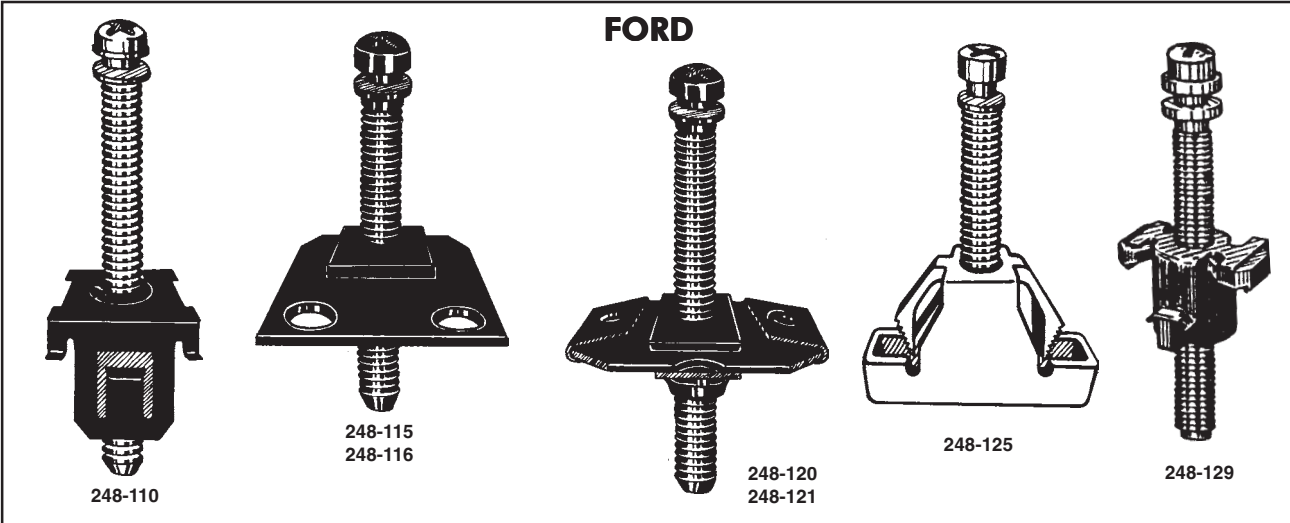

| Stock No. | Factory No. | Year | Application | Screw Dia. x Length |
|-----------|------------------|---------|--|---------------------|
| 248-110 | D7AB-13A093-AA | 1977-up | Ford Cars, Light and Medium Trucks | 12-28 X 1-3/4 |
| 248-115 | D3HB-13A093-AB | 1977-up | Ford Cars, Mustang II and Heavy Trucks | 1/4-28 X 1-3/4 |
| 248-116 | D7SZ-13032-A | 1968-74 | Ford Products | 1/4-28 X 1-3/4 |
| 248-120 | D70B-13A-093-AA | 1976-up | Ford Products | 1/4-28 X 1-3/4 |
| 248-121 | DZ0B-13A-093-AA | 1976-up | Ford Cars and Medium Trucks | 1/4-28 X 1-1/2 |
| 248-125 | D8-BB-13M-093-AA | 1978-up | Ford Products | 12-28 X 1-3/8 |
| 248-129 | D9ZB-13A-093-AA | 1978-up | Ford Products | 12-28 X 1-3/4 |

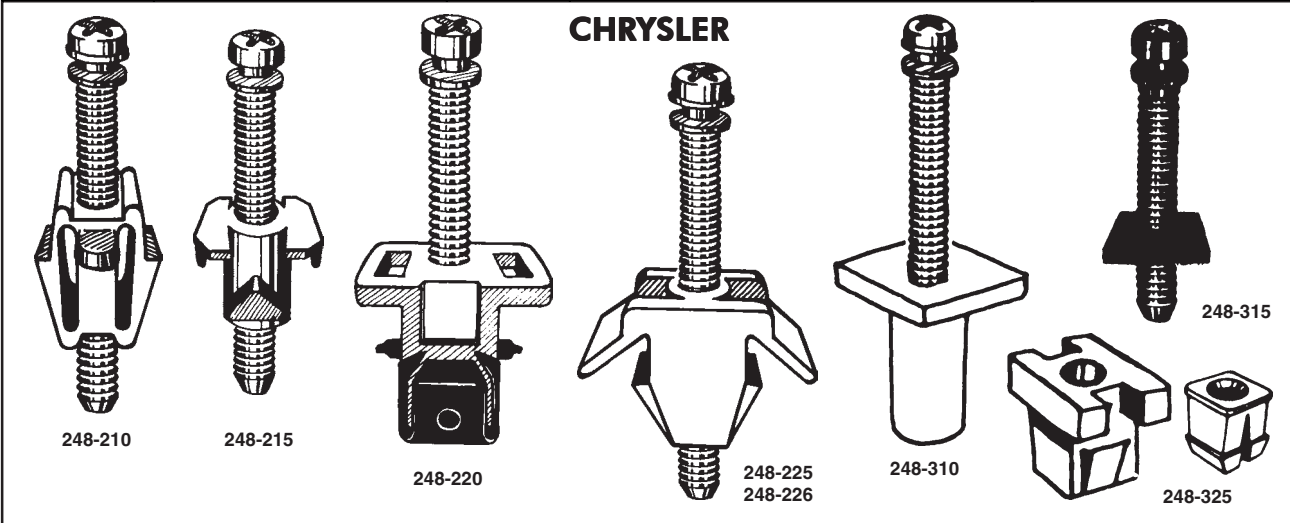

| Stock No. | Factory No. | Year | Application | Screw Dia. x Length |
|-----------|-------------|---------|--------------------------------------|---------------------|
| 248-210 | 3574085 | 1972-up | All Chrysler Inc: Dodge and Plymouth | 12-28 x 1-1/2 |
| 248-215 | 3691599 | 1975-77 | All Chrysler Inc: Dodge and Plymouth | 12-28 x 1-1/2 |
| 248-220 | 2785842 | All | Chrysler Inc: Dodge and Plymouth | 12-28 x 1-1/2 |
| 248-225 | 3868985 | 1977-up | All Chrysler Inc: Dodge and Plymouth | 12-28 x 1-1/2 |
| 248-226 | 5201359 | 1978-up | All Chrysler Inc: Dodge and Plymouth | 12-28 x 2-1/8 |
| 248-310 | — | All | Nissan | 12-28 x 1-1/2 |
| 248-325 | — | All | Toyota | 12-28 x 1-1/2 |

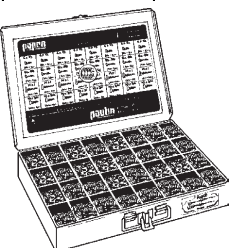

SUPER SERVICE ASSORTMENT No. 020-815

Contains 105 Headlamp Adjusting Screws and Nuts for GM, Ford and Chrysler - 32 items.
Large size, rigid metal box with high-strength plastic compartments.

For more details see page 9.

Large size: 12" w. x 18" l. x 3" d.



249
Series

papco

UTILITY SCISSORS CISEAUX FONCTIONNEL

No. 249-120

Professional quality features stainless steel blades with long-lasting ground edges and high-impact, man-size ABS plastic handles. Individually packaged on 'try-me' blister card.



WORK-SAVERS

papco

UTILITY SHEARS CISAILLES FONCTIONNEL

No. 249-130

Professional quality, stainless steel blades with long-lasting edges. High-impact handles with safety lock. For wire, thin sheet metal, shim stock, vinyl, fibreglass and more. Individually carded.

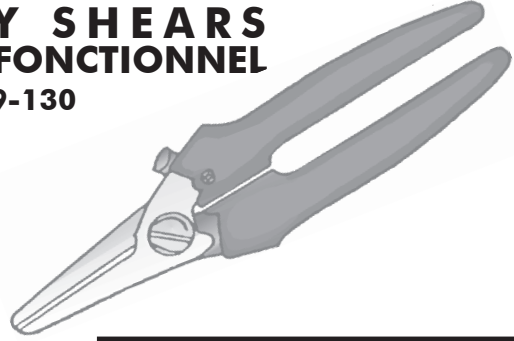

papco

UTILITY SCRAPERS GRATTIORS FONCTIONNEL

'Papco' Utility Scrapers are ideal for trimming, cutting, splicing, scraping paint or stickers. Choose from the retractable, pocket size or standard, angled head for hard-to-reach places - both use either steel or plastic razor blades.



No. 249-124

Angled Head
for hard-to-reach places

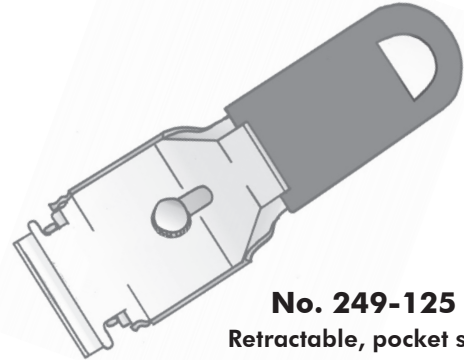

No. 249-125

Retractable, pocket size

papco

REPLACEMENT BLADES LAMES DE RECHANGE

No. 249-126 STEEL RAZOR BLADES



Single edge, industrial duty steel replacement blades for No. 249-124 and 249-125 utility scrapers. Skin packed card contains 10 blades in a recloseable box.

No. 249-127 PLASTIC RAZOR BLADES

For cleaning sun film or laminated glass without cutting or nicking. Fits both 'Papco' Utility Scrapers. Skin packed card contains 100 blades in a recloseable box.

314
Series

papco

PLASTIC PLUG BUTTONS BOUCHONS EN PLASTIQUE

'Papco' Plastic Plug Buttons are used for plugging unsightly body holes after removing accessories, rust-proofing or body repair.

BLACK VINYL



| Stock No. | Size | Std. Pkg. |
|-----------|---------------|-----------|
| 314-318 | 3/8" Diameter | 100 |
| 314-322 | 1/2" Diameter | 100 |
| 314-326 | 3/4" Diameter | 100 |
| 314-328 | 7/8" Diameter | 100 |
| 314-330 | 1" Diameter | 100 |



Consider these important features:

- All metal cabinet for long-life
- Fully illustrated, colour-coded label for speedy selection
- Unique inventory control system
- Refills available from your nearest 'Papco' Jobber

Now for the first time ever the most efficient way of having the right Body Shop Fasteners - where you need them - when you need them!

The coverage selected by professional body men across the country, after months of research, is finally here. All the right parts such as Trim Screws, Body Bolts, Nuts, 'Plastic-Rivets', Trim Fasteners and more - for import and domestic cars and trucks.

The 105 fastest movers in three (3) easy-to-use metal cabinets that keep parts neatly organized and free of dust. The most popular car and truck coverage of Body Shop Fasteners today! A necessity for every body repair outlet.

| No. 022-217 Body Shop Clips Merchandiser | | | | | | | | |
|--|----------|------------------|------|----------|------------------|------|----------|---------------------|
| Qty. | Part No. | Description | Qty. | Part No. | Description | Qty. | Part No. | Description |
| 25 | 247-024 | Trim Fasteners | 25 | 247-406 | 'Plastic' Rivets | 25 | 247-822 | Anchor Nuts |
| 25 | 247-074 | Trim Fasteners | 25 | 247-407 | 'Plastic' Rivets | 25 | 247-830 | Anchor Nuts |
| 25 | 247-080 | Trim Fasteners | 25 | 247-411 | 'Plastic' Rivets | 25 | 247-854 | Anchor Nuts |
| 25 | 247-085 | Trim Fasteners | 25 | 247-462 | 'Plastic' Rivets | 25 | 247-855 | Anchor Nuts |
| 25 | 247-210 | Trim Fasteners | 25 | 247-490 | 'Plastic' Rivets | 10 | 248-020 | Headlamp Screws |
| 50* | 247-211 | Trim Fasteners | 25 | 247-494 | 'Plastic' Rivets | 10 | 248-031 | Headlamp Screws |
| 25 | 247-216 | Trim Fasteners | 25 | 247-715 | Anchor Grommets | 10 | 248-226 | Headlamp Screws |
| 10* | 247-249 | Trim Fasteners | 25 | 247-810 | Anchor Nuts | 25 | 250-550 | Door Hinge Bushings |
| 25 | 247-308 | Nylon Rivets | 25 | 247-815 | Anchor Nuts | 25 | 250-553 | Door Hinge Bushings |
| 15 | 247-401 | 'Plastic' Rivets | 25 | 247-819 | Anchor Nuts | 2 | 250-559 | Door Hinge Pins |
| 25 | 247-405 | 'Plastic' Rivets | 25 | 247-821 | Anchor Nuts | 5x5 | 997-594 | Panel Drill Bits |

*Quantity represents two boxes

| No. 022-218 Body Bolts and Retainers Merchandiser | | | | | | | | |
|---|----------|-----------------|------|----------|-----------------------|------|----------|-------------|
| Qty. | Part No. | Description | Qty. | Part No. | Description | Qty. | Part No. | Description |
| 25 | 241-606 | Metric 'U' Nuts | 100 | 242-322 | Bolt Retainers | 25 | 245-407 | Body Bolts |
| 25 | 241-607 | Metric 'U' Nuts | 100 | 243-306 | Metric Bolt Retainers | 25 | 245-408 | Body Bolts |
| 25 | 241-608 | Metric 'U' Nuts | 100 | 243-308 | Metric Bolt Retainers | 25 | 245-420 | Body Bolts |
| 25 | 241-609 | Metric 'U' Nuts | 25 | 244-957 | Metric Washer Nuts | 25 | 245-440 | Body Bolts |
| 10 | 241-610 | Metric 'U' Nuts | 25 | 244-986 | Metric Washer Nuts | 10 | 245-450 | Body Bolts |
| 50 | 242-206 | Palnuts | 25 | 244-987 | Metric Washer Nuts | 25 | 245-505 | Body Bolts |
| 50 | 242-210 | Palnuts | 25 | 244-988 | Metric Washer Nuts | 25 | 245-525 | Body Bolts |
| 50 | 242-215 | Palnuts | 12 | 245-165 | Bumber Bar Bolts | 25 | 245-527 | Body Bolts |
| 50 | 242-216 | Palnuts | 12 | 245-172 | Bumber Bar Bolts | 25 | 250-363 | Body Shims |
| 100 | 242-314 | Bolt Retainers | 6 | 245-183 | Bumber Bar Bolts | 25 | 250-371 | Body Shims |
| 100 | 242-316 | Bolt Retainers | 10 | 245-220 | Bumber Bar Bolts | 25 | 250-372 | Body Shims |
| 100 | 242-318 | Bolt Retainers | 25 | 245-400 | Body Bolts | | | |

| No. 022-219 Trim Screws Merchandiser | | | | | | | | |
|--------------------------------------|----------|-------------------------|------|----------|--------------------------|------|----------|-----------------------|
| Qty. | Part No. | Description | Qty. | Part No. | Description | Qty. | Part No. | Description |
| 100 | 213-278 | Hex Tapping Screws | 100 | 229-405 | Washer Head Trim Scr. | 100 | 229-982 | Pan Trim Screws-Black |
| 50 | 213-444 | Hex Tapping Screws | 50 | 229-855 | Oval Sems - Black | 100 | 230-302 | Metric Screw |
| 100 | 229-122 | Pan Trim Screws - Zinc | 100 | 229-911 | Oval Trim Screws - Black | 100 | 230-303 | Metric Screw |
| 100 | 229-124 | Pan Trim Screws - Zinc | 100 | 229-915 | Oval Trim Screws - Black | 100 | 230-305 | Metric Screw |
| 100 | 229-144 | Pan Trim Screws - Zinc | 100 | 229-919 | Oval Trim Screws - Black | 100 | 230-306 | Metric Screw |
| 100 | 229-164 | Pan Trim Screws - Zinc | 100 | 229-923 | Oval Trim Screws - Black | 100 | 240-228 | Speed Nuts |
| 100 | 229-222 | Oval Trim Screws - Zinc | 100 | 229-933 | Oval Trim Screws - Black | 25 | 240-708 | 'U' Nuts |
| 100 | 229-224 | Oval Trim Screws - Zinc | 100 | 229-937 | Oval Trim Screws - Black | 25 | 240-709 | 'U' Nuts |
| 100 | 229-226 | Oval Trim Screws - Zinc | 100 | 229-960 | Pan Trim Screws - Black | 25 | 240-710 | 'U' Nuts |
| 100 | 229-228 | Oval Trim Screws - Zinc | 100 | 229-968 | Pan Trim Screws - Black | 100* | 245-906 | Lic. Plate Bolts |
| 100 | 229-242 | Oval Trim Screws - Zinc | 100 | 229-972 | Pan Trim Screws - Black | | | |
| 100 | 229-244 | Oval Trim Screws - Zinc | 100 | 229-980 | Pan Trim Screws - Black | | | |

*Quantity represents two boxes



CARDED BODY SHOP FASTENERS MERCHANDISERS

CARDED

HEADLAMP SCREW MERCHANDISER No. 022-122

Includes Rack, Header Sign, Inventory Control Strips, Planogram and a 20 card starter stock of the items listed below.

| Card No. | Cat. No. | Description | Pcs/Card | Card No. | Cat. No. | Description | Pcs/Card |
|----------|----------|-----------------|----------|--------------------------------|----------|-----------------|----------|
| 248-601 | 248-001 | GM Universal | 2 | 248-721 | 248-121 | '73 up Ford | 2 |
| 248-605* | 248-005 | '75 up GM | 2 | 248-729 | 248-129 | '79 up Ford | 2 |
| 248-606 | 248-125 | '78 up GM, Ford | 2 | 248-805 | 248-205 | '78 up Chrysler | 2 |
| 248-620 | 248-020 | '76 up GM | 2 | 248-810 | 248-210 | '70 up Chrysler | 2 |
| 248-625 | 248-025 | '75 up GM | 2 | 248-820 | 248-220 | '68 up Chrysler | 2 |
| 248-635* | 248-035 | '75 up GM | 2 | 248-910 | 248-310 | Datsun | 2 |
| 248-645 | 248-045 | '69 up GM | 2 | 248-920 | 248-320 | Honda | 2 |
| 248-650 | 248-050 | '75 up GM | 2 | 248-925 | 248-325 | Toyota | 4 |
| 248-710 | 248-110 | '77 up Ford | 2 | * Indicates item double-pegged | | | |
| 248-715 | 248-115 | '73 up Ford | 2 | | | | |

CARDED

'PLASTI-RIVET' MERCHANDISER No. 022-140

Includes Rack, Header Sign, Inventory Control Strips, Planogram and a 20 card starter stock of the items listed below.

| Card No. | Cat. No. | Description | Pcs/Card | Card No. | Cat. No. | Description |
|----------|----------|-------------------|----------|----------|----------|----------------|
| 247-320 | 247-300 | 5mmx6mm | 3 | 247-517 | 247-402 | GM Rivet |
| 247-321 | 247-301 | 6.3mmx10mm | 3 | 247-518 | 247-403 | GM Rivet |
| 247-322 | 247-302 | 6.3mmx6mm | 3 | 247-519 | 247-404 | GM Rivet |
| 247-323 | 247-303 | 6.3mmx10mm | 3 | 247-520 | 247-405 | GM Rivet |
| 247-324 | 247-304 | 6.6mmx5mm | 3 | 247-521 | 247-406 | GM, Ford Rivet |
| 247-325 | 247-305 | 6.6mmx5mm | 3 | 247-522 | 247-407 | GM Rivet |
| 247-326 | 247-306 | 5mmx4.5mm | 3 | 247-523 | 247-408 | GM Rivet |
| 247-327 | 247-307 | 5mmx10mm | 3 | 247-526 | 247-411 | GM Rivet |
| 247-328 | 247-308 | 3/16dia. Ford Riv | 3 | 247-530 | 247-530 | GM Rivet |
| 247-516 | 247-401 | GM Rivet | 2 | 247-535 | 247-535 | GM Rivet |

CARDED

GM TRIM FASTENER MERCHANDISER No. 022-141

Includes Rack, Header Sign, Inventory Control Strips, Planogram and a 40 card starter stock of the items listed below.

| Card No. | Cat. No. | Description | Pcs/Card | Card No. | Cat. No. | Description | Pcs/Card |
|----------|----------|-------------|----------|----------|----------|-------------|----------|
| 247-921 | 247-012 | GM | 5 | 247-915 | 247-210 | GM | 2 |
| 247-902 | 247-020 | GM | 4 | 247-958 | 247-211 | GM | 4 |
| 247-929 | 247-056 | GM | 3 | 247-959 | 247-212 | GM | 4 |
| 247-950 | 247-061 | GM | 2 | 247-916 | 247-215 | GM | 4 |
| 247-908 | 247-080 | GM | 4 | 247-960 | 247-216 | GM | 3 |
| 247-953 | 247-082 | GM | 3 | 247-920 | 247-220 | GM | 2 |
| 247-909 | 247-085 | GM | 2 | 247-962 | 247-222 | GM | 4 |
| 247-935 | 247-101 | GM | 2 | 247-932 | 247-248 | GM | 2 |
| 247-912 | 247-150 | GM | 4 | 247-941 | 247-249 | GM | 2 |
| 247-913 | 247-155 | GM | 4 | 247-940 | 247-250 | GM | 2 |

CARDED

'PLASTI-RIVET' and GROMMET MERCHANDISER No. 022-142

Includes Rack, Header Sign, Inventory Control Strips, Planogram and a 20 card starter stock of the items listed below.

| Card No. | Cat. No. | Description | Pcs/Card | Card No. | Cat. No. | Description |
|----------|----------|----------------|----------|----------|----------|-------------------|
| 247-565 | 247-450 | GM Rivet | 2 | 247-964 | 247-712 | GM Grille |
| 247-575 | 247-460 | GM Rivet | 2 | 247-970 | 247-725 | Chrysler Rad |
| 247-577 | 247-462 | Ford Rivet | 3 | 247-971 | 247-730 | Ford Grille |
| 247-579 | 247-464 | Ford Rivet | 4 | 247-977 | 247-735 | GM, Chrysler |
| 247-580 | 247-465 | Ford Rivet | 4 | 247-978 | 247-810 | Ford Headlamp |
| 247-581 | 247-466 | Ford, GM Rivet | 4 | 247-973 | 247-810 | GM Marker Light |
| 247-582 | 247-467 | Ford Rivet | 3 | 247-974 | 247-815 | GM Grille |
| 247-583 | 247-468 | Ford Rivet | 2 | 247-979 | 247-819 | GM |
| 247-585 | 247-470 | Ford Rivet | 4 | 247-981 | 247-822 | Chrysler Headlm. |
| 247-961 | 247-661 | GM Grommet | 2 | 247-975 | 247-840 | 1/4-20 Lic. Plate |

CARDED

REVEAL WINDSHIELD CLIP MERCHANDISER No. 022-143

Includes Rack, Header Sign, Inventory Control Strips, Planogram and a 40 card starter stock of the items listed below.

| Card No. | Cat. No. | Description | Pcs/Card | Card No. | Cat. No. | Description | Pcs/Card |
|----------|----------|-------------|----------|----------|----------|-------------|----------|
| 246-959 | 246-409 | GM | 5 | 246-969 | 246-419 | GM | 3 |
| 246-960 | 246-410 | GM | 5 | 246-970 | 246-420 | GM | 4 |
| 246-961 | 246-411 | GM | 5 | 246-975 | 246-425 | GM | 4 |
| 246-962 | 246-412 | Ford | 5 | 246-976 | 246-426 | Ford | 3 |
| 246-963 | 246-413 | GM | 5 | 246-977 | 246-427 | Ford | 3 |
| 246-964 | 246-414 | Ford | 5 | 246-978 | 246-428 | Ford | 3 |
| 246-965 | 246-415 | Ford | 3 | 246-979 | 246-429 | Ford | 3 |
| 246-966 | 246-416 | Chrysler | 2 | 246-985 | 246-435 | Chrysler | 5 |
| 246-967 | 246-417 | GM | 5 | 246-986 | 246-436 | Chrysler | 5 |
| 246-968 | 246-418 | GM | 5 | 246-988 | 246-438 | Chrysler | 5 |

CARDED

MOULDING BOLT MERCHANDISER No. 022-147

Includes Rack, Header Sign, Inventory Control Strips, Planogram and a 40 card starter stock of the items listed below.

| Card No. | Cat. No. | Description | Pcs/Card | Card No. | Cat. No. | Description | Pcs/Card |
|----------|----------|-------------|----------|--------------------------------|----------|-------------|----------|
| 246-902 | 246-112 | Universal | 1 | 246-906 | 246-398 | GM | 4 |
| 246-912 | 246-212 | GM | 1 | 246-907 | 246-399 | GM | 2 |
| 246-914 | 246-214 | GM | 1 | 246-400 | 246-400 | Universal | 1 |
| 246-916* | 246-216 | GM | 1 | 246-951 | 246-401 | GM | 4 |
| 246-920 | 246-218 | Ford | 1 | 246-952 | 246-402 | GM | 4 |
| 246-922 | 246-222 | Ford | 1 | 246-953 | 246-403 | Ford | 4 |
| 246-918 | 246-228 | Ford | 1 | 246-955 | 246-405 | Chrysler | 4 |
| 246-903 | 246-395 | GM | 4 | 246-957 | 246-407 | Ford | 4 |
| 246-904 | 246-396 | GM | 4 | 246-958 | 246-408 | GM | 4 |
| 246-905 | 234-397 | GM | 4 | * Indicates item double-pegged | | | |

CARDED

FORD, CHRYSLER TRIM FASTENER MERCHANDISER No. 022-149

Includes Rack, Header Sign, Inventory Control Strips, Planogram and a 40 card starter stock of the items listed below.

| Card No. | Cat. No. | Description | Pcs/Card | Card No. | Cat. No. | Description | Pcs/Card |
|----------|----------|----------------|----------|----------|----------|-------------|----------|
| 247-922 | 247-024 | Ford | 3 | 247-949 | 247-149 | Ford | 2 |
| 247-903 | 247-025 | Ford, Chrysler | 2 | 247-957 | 247-160 | Chrysler | 4 |
| 247-923 | 247-026 | Chrysler | 3 | 247-914 | 247-165 | Ford | 4 |
| 247-924 | 247-038 | Ford | 3 | 247-938 | 247-231 | Ford | 2 |
| 247-906 | 247-050 | Chrysler | 2 | 247-943 | 247-232 | Ford | 4 |
| 247-907 | 247-055 | Ford | 2 | 247-919 | 247-235 | Ford | 2 |
| 247-951 | 247-062 | Ford | 3 | 247-963 | 247-236 | Chrysler | 3 |
| 247-952 | 247-065 | Ford | 3 | 247-933 | 247-238 | Chrysler | 2 |
| 247-911 | 247-110 | Ford | 2 | 247-939 | 247-245 | Ford | 2 |
| 247-955 | 247-136 | Chrysler | 4 | 247-937 | 247-253 | Ford | 2 |

CARDED

WINDOW HANDLE MERCHANDISER No. 022-152

Includes Hooks, Header Sign, Inventory Control Tags, Planogram and a 22 card starter stock of the items listed below.

| Card No. | Cat. No. | Description | Pcs/Card | Card No. | Cat. No. | Description | Pcs/Card |
|----------------|----------|------------------|----------|---------------------|----------|-------------------|----------|
| Window Handles | | | | Window Handles | | | |
| 246-700 | - | GM Clear | 1 | 246-791 | - | Audi, VW | 1 |
| 246-701 | - | GM Black | 1 | 246-790 | - | Ford (Inside) | 1 |
| 246-702 | - | GM, GMC Trucks | 1 | 246-791 | - | Chrysler (Outsd.) | 1 |
| 246-715 | - | Ford Clear | 1 | 246-792 | - | Chrysler (Outsd.) | 1 |
| 246-716 | - | Ford Black | 1 | Door Handles | | | |
| 246-717 | - | Ford Dbl.-Prong | 1 | 246-800 | - | GM (Clear) | 1 |
| 246-735 | - | Chry. Chrome Ctr | 1 | 246-801 | - | GM (Black) | 1 |
| 246-760 | - | Honda Civic | 1 | 246-810 | - | Ford (Clear) | 1 |
| 246-761 | - | Honda Exc. Civic | 1 | 246-811 | - | Ford (Black) | 1 |
| 246-770 | - | Toyota | 1 | 246-830 | - | AMC (Black) | 1 |
| 246-771 | - | Toyota | 1 | Window Handle Knobs | | | |
| | | | | 246-840 | - | Assl. Hand. Clips | 8 |
| | | | | 246-895 | - | Removing Tool | 1 |

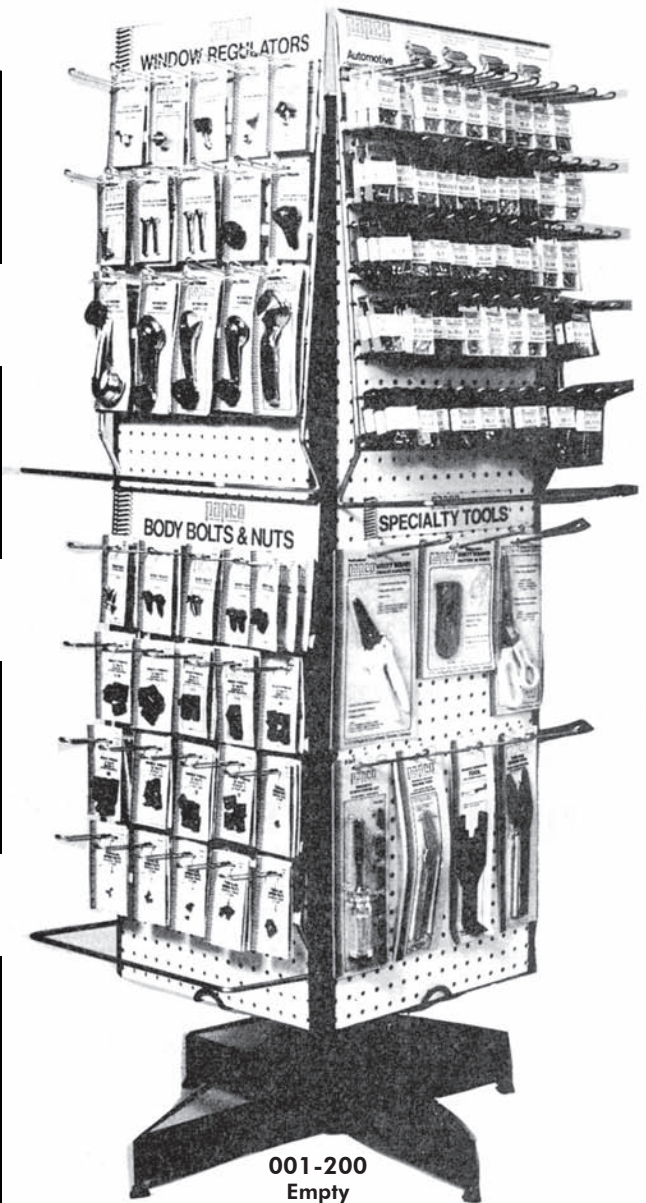

001-200
Empty
Revolving Floor Pylon



250
Series

Papco CASTER and CAMBER SHIMS CALES pour CHASSE DIRECTION

"Papco" Shims are used to adjust caster on knee-action and ball-joint suspensions.
All "Papco" shims are plated to resist rust and stamped with thickness or degree.

Order by Stock Number Double Slot Type 6 Pcs. Per Package
Single Slot Type 25 Pcs. Per Package

| | <table border="1"> <thead> <tr> <th>Stock No.</th> <th>Thick.</th> <th>°Change</th> </tr> </thead> <tbody> <tr> <td>250-002</td> <td>1/16"</td> <td>1/4°</td> </tr> <tr> <td>250-004</td> <td>1/8"</td> <td>1/2°</td> </tr> <tr> <td>250-006</td> <td>3/16"</td> <td>3/4°</td> </tr> <tr> <td>250-008</td> <td>1/4"</td> <td>1°</td> </tr> </tbody> </table> | Stock No. | Thick. | °Change | 250-002 | 1/16" | 1/4° | 250-004 | 1/8" | 1/2° | 250-006 | 3/16" | 3/4° | 250-008 | 1/4" | 1° | | <table border="1"> <thead> <tr> <th>Stock No.</th> <th>Thick.</th> <th>Slot</th> </tr> </thead> <tbody> <tr> <td>250-160</td> <td>1/32"</td> <td>9/16"</td> </tr> <tr> <td>250-161</td> <td>1/16"</td> <td>9/16"</td> </tr> <tr> <td>250-162</td> <td>1/8"</td> <td>9/16"</td> </tr> </tbody> </table> | Stock No. | Thick. | Slot | 250-160 | 1/32" | 9/16" | 250-161 | 1/16" | 9/16" | 250-162 | 1/8" | 9/16" | | | | | | |
|---|--|-----------|--------|---------|---------|-------|--------|---------|-------|--------|---------|-------|--------|---------|--|-----------|--------|---|-----------|--------|--------|---------|-------|--------|---------|-------|--------|---------|-------|-------|---------|------|------|---------|-------|------|
| Stock No. | Thick. | °Change | | | | | | | | | | | | | | | | | | | | | | | | | | | | | | | | | | |
| 250-002 | 1/16" | 1/4° | | | | | | | | | | | | | | | | | | | | | | | | | | | | | | | | | | |
| 250-004 | 1/8" | 1/2° | | | | | | | | | | | | | | | | | | | | | | | | | | | | | | | | | | |
| 250-006 | 3/16" | 3/4° | | | | | | | | | | | | | | | | | | | | | | | | | | | | | | | | | | |
| 250-008 | 1/4" | 1° | | | | | | | | | | | | | | | | | | | | | | | | | | | | | | | | | | |
| Stock No. | Thick. | Slot | | | | | | | | | | | | | | | | | | | | | | | | | | | | | | | | | | |
| 250-160 | 1/32" | 9/16" | | | | | | | | | | | | | | | | | | | | | | | | | | | | | | | | | | |
| 250-161 | 1/16" | 9/16" | | | | | | | | | | | | | | | | | | | | | | | | | | | | | | | | | | |
| 250-162 | 1/8" | 9/16" | | | | | | | | | | | | | | | | | | | | | | | | | | | | | | | | | | |
| <p>Universal Type, Fits Many Cars 1-1/4" w. x 3-1/2" l.</p> | <p>3/4 and 1 Ton Chevrolet and GMC Trucks 1963-up 1-1/2" w. x 2-7/16" l.</p> | | | | | | | | | | | | | | | | | | | | | | | | | | | | | | | | | | | |
| | <table border="1"> <thead> <tr> <th>Stock No.</th> <th>Thick.</th> <th>Slot</th> </tr> </thead> <tbody> <tr> <td>250-081</td> <td>1/32"</td> <td>1/2"</td> </tr> <tr> <td>250-082</td> <td>1/16"</td> <td>1/2"</td> </tr> <tr> <td>250-083</td> <td>1/8"</td> <td>1/2"</td> </tr> </tbody> </table> | Stock No. | Thick. | Slot | 250-081 | 1/32" | 1/2" | 250-082 | 1/16" | 1/2" | 250-083 | 1/8" | 1/2" | | <table border="1"> <thead> <tr> <th>Stock No.</th> <th>Thick.</th> <th>Slot</th> </tr> </thead> <tbody> <tr> <td>250-166</td> <td>.060"</td> <td>19/32"</td> </tr> <tr> <td>250-168</td> <td>.080"</td> <td>19/32"</td> </tr> <tr> <td>250-170</td> <td>.100"</td> <td>19/32"</td> </tr> </tbody> </table> | Stock No. | Thick. | Slot | 250-166 | .060" | 19/32" | 250-168 | .080" | 19/32" | 250-170 | .100" | 19/32" | | | | | | | | | |
| Stock No. | Thick. | Slot | | | | | | | | | | | | | | | | | | | | | | | | | | | | | | | | | | |
| 250-081 | 1/32" | 1/2" | | | | | | | | | | | | | | | | | | | | | | | | | | | | | | | | | | |
| 250-082 | 1/16" | 1/2" | | | | | | | | | | | | | | | | | | | | | | | | | | | | | | | | | | |
| 250-083 | 1/8" | 1/2" | | | | | | | | | | | | | | | | | | | | | | | | | | | | | | | | | | |
| Stock No. | Thick. | Slot | | | | | | | | | | | | | | | | | | | | | | | | | | | | | | | | | | |
| 250-166 | .060" | 19/32" | | | | | | | | | | | | | | | | | | | | | | | | | | | | | | | | | | |
| 250-168 | .080" | 19/32" | | | | | | | | | | | | | | | | | | | | | | | | | | | | | | | | | | |
| 250-170 | .100" | 19/32" | | | | | | | | | | | | | | | | | | | | | | | | | | | | | | | | | | |
| <p>General Motors 1971-up 1-3/16" w. x 1-1/8" l.</p> | <p>Buick 1957-up 1" w. x 1-5/8" l.</p> | | | | | | | | | | | | | | | | | | | | | | | | | | | | | | | | | | | |
| | <table border="1"> <thead> <tr> <th>Stock No.</th> <th>Thick.</th> <th>Slot</th> </tr> </thead> <tbody> <tr> <td>250-091</td> <td>1/32"</td> <td>17/32"</td> </tr> <tr> <td>250-092</td> <td>1/16"</td> <td>17/32"</td> </tr> <tr> <td>250-093</td> <td>1/8"</td> <td>17/32"</td> </tr> </tbody> </table> | Stock No. | Thick. | Slot | 250-091 | 1/32" | 17/32" | 250-092 | 1/16" | 17/32" | 250-093 | 1/8" | 17/32" | | <table border="1"> <thead> <tr> <th>Stock No.</th> <th>Thick.</th> <th>Slot</th> </tr> </thead> <tbody> <tr> <td>250-176</td> <td>1/32"</td> <td>9/16"</td> </tr> <tr> <td>250-177</td> <td>1/16"</td> <td>9/16"</td> </tr> <tr> <td>250-179</td> <td>3/16"</td> <td>9/16"</td> </tr> </tbody> </table> | Stock No. | Thick. | Slot | 250-176 | 1/32" | 9/16" | 250-177 | 1/16" | 9/16" | 250-179 | 3/16" | 9/16" | | | | | | | | | |
| Stock No. | Thick. | Slot | | | | | | | | | | | | | | | | | | | | | | | | | | | | | | | | | | |
| 250-091 | 1/32" | 17/32" | | | | | | | | | | | | | | | | | | | | | | | | | | | | | | | | | | |
| 250-092 | 1/16" | 17/32" | | | | | | | | | | | | | | | | | | | | | | | | | | | | | | | | | | |
| 250-093 | 1/8" | 17/32" | | | | | | | | | | | | | | | | | | | | | | | | | | | | | | | | | | |
| Stock No. | Thick. | Slot | | | | | | | | | | | | | | | | | | | | | | | | | | | | | | | | | | |
| 250-176 | 1/32" | 9/16" | | | | | | | | | | | | | | | | | | | | | | | | | | | | | | | | | | |
| 250-177 | 1/16" | 9/16" | | | | | | | | | | | | | | | | | | | | | | | | | | | | | | | | | | |
| 250-179 | 3/16" | 9/16" | | | | | | | | | | | | | | | | | | | | | | | | | | | | | | | | | | |
| <p>Ford 1954-up Meteor 1954-up 1-1/16" w. x 1" l.</p> | <p>Chevrolet and GMC Light Trucks, Series 10-40 1960-up 1-1/4" w. x 2" l.</p> | | | | | | | | | | | | | | | | | | | | | | | | | | | | | | | | | | | |
| | <table border="1"> <thead> <tr> <th>Stock No.</th> <th>Thick.</th> <th>Slot</th> </tr> </thead> <tbody> <tr> <td>250-095</td> <td>1/64"</td> <td>19/32"</td> </tr> <tr> <td>250-096</td> <td>1/32"</td> <td>19/32"</td> </tr> <tr> <td>250-097</td> <td>1/16"</td> <td>19/32"</td> </tr> <tr> <td>250-098</td> <td>1/8"</td> <td>19/32"</td> </tr> </tbody> </table> | Stock No. | Thick. | Slot | 250-095 | 1/64" | 19/32" | 250-096 | 1/32" | 19/32" | 250-097 | 1/16" | 19/32" | 250-098 | 1/8" | 19/32" | | <table border="1"> <thead> <tr> <th>Stock No.</th> <th>Thick.</th> <th>Slot</th> </tr> </thead> <tbody> <tr> <td>250-184</td> <td>1/64"</td> <td>1/2"</td> </tr> <tr> <td>250-185</td> <td>1/32"</td> <td>1/2"</td> </tr> <tr> <td>250-186</td> <td>1/16"</td> <td>1/2"</td> </tr> <tr> <td>250-187</td> <td>1/8"</td> <td>1/2"</td> </tr> <tr> <td>250-188</td> <td>3/16"</td> <td>1/2"</td> </tr> </tbody> </table> | Stock No. | Thick. | Slot | 250-184 | 1/64" | 1/2" | 250-185 | 1/32" | 1/2" | 250-186 | 1/16" | 1/2" | 250-187 | 1/8" | 1/2" | 250-188 | 3/16" | 1/2" |
| Stock No. | Thick. | Slot | | | | | | | | | | | | | | | | | | | | | | | | | | | | | | | | | | |
| 250-095 | 1/64" | 19/32" | | | | | | | | | | | | | | | | | | | | | | | | | | | | | | | | | | |
| 250-096 | 1/32" | 19/32" | | | | | | | | | | | | | | | | | | | | | | | | | | | | | | | | | | |
| 250-097 | 1/16" | 19/32" | | | | | | | | | | | | | | | | | | | | | | | | | | | | | | | | | | |
| 250-098 | 1/8" | 19/32" | | | | | | | | | | | | | | | | | | | | | | | | | | | | | | | | | | |
| Stock No. | Thick. | Slot | | | | | | | | | | | | | | | | | | | | | | | | | | | | | | | | | | |
| 250-184 | 1/64" | 1/2" | | | | | | | | | | | | | | | | | | | | | | | | | | | | | | | | | | |
| 250-185 | 1/32" | 1/2" | | | | | | | | | | | | | | | | | | | | | | | | | | | | | | | | | | |
| 250-186 | 1/16" | 1/2" | | | | | | | | | | | | | | | | | | | | | | | | | | | | | | | | | | |
| 250-187 | 1/8" | 1/2" | | | | | | | | | | | | | | | | | | | | | | | | | | | | | | | | | | |
| 250-188 | 3/16" | 1/2" | | | | | | | | | | | | | | | | | | | | | | | | | | | | | | | | | | |
| <p>Lincoln 1952-up Pontiac 1957-up Oldsmob. 1957-up Cadillac 1957-up 1-1/8" w. x 1-3/8" l.</p> | <p>Chevrolet 1971-up Buick, Pontiac 1968-up 1" w. x 1-1/2" l.</p> | | | | | | | | | | | | | | | | | | | | | | | | | | | | | | | | | | | |
| <p>*Also Used as Body Shim for Ford Products through 1981.</p> | <table border="1"> <thead> <tr> <th>Stock No.</th> <th>Thick.</th> <th>Slot</th> </tr> </thead> <tbody> <tr> <td>250-192</td> <td>1/64"</td> <td>5/8"</td> </tr> <tr> <td>250-193</td> <td>1/32"</td> <td>5/8"</td> </tr> <tr> <td>250-194</td> <td>1/16"</td> <td>5/8"</td> </tr> <tr> <td>250-195</td> <td>1/8"</td> <td>5/8"</td> </tr> </tbody> </table> | Stock No. | Thick. | Slot | 250-192 | 1/64" | 5/8" | 250-193 | 1/32" | 5/8" | 250-194 | 1/16" | 5/8" | 250-195 | 1/8" | 5/8" | | | | | | | | | | | | | | | | | | | | |
| Stock No. | Thick. | Slot | | | | | | | | | | | | | | | | | | | | | | | | | | | | | | | | | | |
| 250-192 | 1/64" | 5/8" | | | | | | | | | | | | | | | | | | | | | | | | | | | | | | | | | | |
| 250-193 | 1/32" | 5/8" | | | | | | | | | | | | | | | | | | | | | | | | | | | | | | | | | | |
| 250-194 | 1/16" | 5/8" | | | | | | | | | | | | | | | | | | | | | | | | | | | | | | | | | | |
| 250-195 | 1/8" | 5/8" | | | | | | | | | | | | | | | | | | | | | | | | | | | | | | | | | | |
| | <table border="1"> <thead> <tr> <th>Stock No.</th> <th>Thick.</th> <th>Slot</th> </tr> </thead> <tbody> <tr> <td>250-105</td> <td>1/64"</td> <td>15/32"</td> </tr> <tr> <td>250-106</td> <td>1/32"</td> <td>15/32"</td> </tr> <tr> <td>250-107</td> <td>1/16"</td> <td>15/32"</td> </tr> <tr> <td>250-108</td> <td>1/8"</td> <td>15/32"</td> </tr> </tbody> </table> | Stock No. | Thick. | Slot | 250-105 | 1/64" | 15/32" | 250-106 | 1/32" | 15/32" | 250-107 | 1/16" | 15/32" | 250-108 | 1/8" | 15/32" | | <p>Universal 1-3/8" w. x 1-1/4" l.</p> | | | | | | | | | | | | | | | | | | |
| Stock No. | Thick. | Slot | | | | | | | | | | | | | | | | | | | | | | | | | | | | | | | | | | |
| 250-105 | 1/64" | 15/32" | | | | | | | | | | | | | | | | | | | | | | | | | | | | | | | | | | |
| 250-106 | 1/32" | 15/32" | | | | | | | | | | | | | | | | | | | | | | | | | | | | | | | | | | |
| 250-107 | 1/16" | 15/32" | | | | | | | | | | | | | | | | | | | | | | | | | | | | | | | | | | |
| 250-108 | 1/8" | 15/32" | | | | | | | | | | | | | | | | | | | | | | | | | | | | | | | | | | |
| <p>Camaro, Chevelle 1967-up Chevrolet 1955-up Pontiac 1955-up Buick 1961-up Oldsmob. 1961-up 15/16" w. x 1-9/16" l.</p> | <table border="1"> <thead> <tr> <th>Stock No.</th> <th>Thick.</th> <th>Slot</th> </tr> </thead> <tbody> <tr> <td>250-196</td> <td>1/32"</td> <td>9/16"</td> </tr> <tr> <td>250-197</td> <td>1/16"</td> <td>9/16"</td> </tr> <tr> <td>250-198</td> <td>1/8"</td> <td>9/16"</td> </tr> </tbody> </table> | Stock No. | Thick. | Slot | 250-196 | 1/32" | 9/16" | 250-197 | 1/16" | 9/16" | 250-198 | 1/8" | 9/16" | | <p>Oldsmobile 1957-up 1-7/16" w. x 1-3/8" l.</p> | | | | | | | | | | | | | | | | | | | | | |
| Stock No. | Thick. | Slot | | | | | | | | | | | | | | | | | | | | | | | | | | | | | | | | | | |
| 250-196 | 1/32" | 9/16" | | | | | | | | | | | | | | | | | | | | | | | | | | | | | | | | | | |
| 250-197 | 1/16" | 9/16" | | | | | | | | | | | | | | | | | | | | | | | | | | | | | | | | | | |
| 250-198 | 1/8" | 9/16" | | | | | | | | | | | | | | | | | | | | | | | | | | | | | | | | | | |

Papco UNIVERSAL CASTER and CAMBER SHIMS

Designed to replace single slot shims with a slot width of from 7/16" to 21/32". The slot is tapered allowing shim to drop over stud to correct position. Can be used on most applications now covered by 250-091, 093 series, 250-095, 098 and 250-105, 108 series.



Universal

Standard Package 25 Shims

| Stock No. | Thick. | Slot |
|-----------|--------|----------------|
| 250-281 | 1/64" | 7/16 to 21/32" |
| 250-282 | 1/32" | 7/16 to 21/32" |
| 250-283 | 1/16" | 7/16 to 21/32" |
| 250-284 | 1/8" | 7/16 to 21/32" |

1-3/16" w. x 1-1/2" long





250
Series

papco

BODY SHIMS
CALES DE CARROSSERIE

- Used for alignment of Hoods, Fenders, Cowls and Starter Motors
- Plated Steel - Standard Package Contains 25 Shims

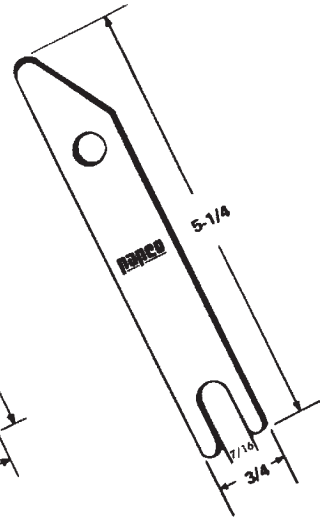
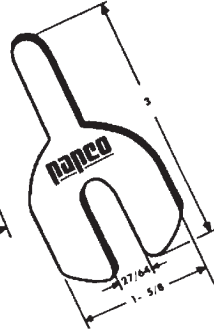
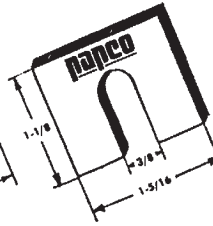
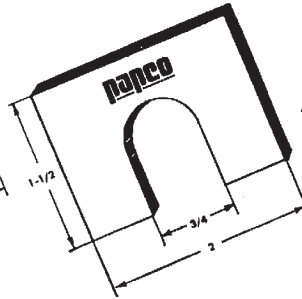
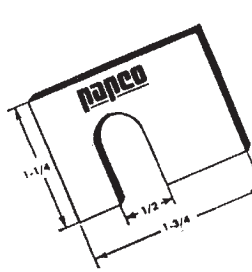

| BODY SHIM | |
|-----------|-----------|
| Stock No. | Thickness |
| 250-361 | 1/32" |
| 250-362 | 1/16" |
| 250-363 | 1/8" |

| BODY SHIM | |
|-----------|-----------|
| Stock No. | Thickness |
| 250-368 | 1/8" |
| Ford | |

| HOOD SHIM | |
|-----------|-----------|
| Stock No. | Thickness |
| 250-371 | 1/16" |
| 250-372 | 1/8" |
| Chevrolet | |

| FENDER SHIM | |
|-------------|-----------|
| Stock No. | Thickness |
| 250-380 | 1/16" |
| 250-382 | 1/8" |
| GM | |

| STARTER MOTOR SHIM | |
|---------------------|-----------|
| Stock No. | Thickness |
| 250-390 | 1/64" |
| 250-391 | 1/32" |
| 250-392 | 1/16" |
| GM9785608, 10008053 | |

papco

BODY ALIGNING SHIM

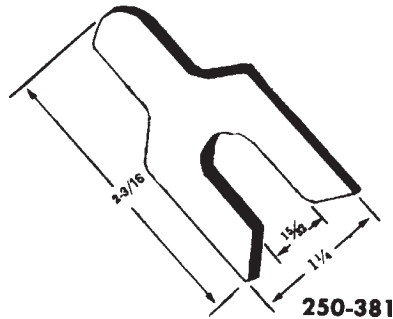

No. 250-381
UNIVERSAL GM APPLICATION

These 1/16" thick steel shims have numerous applications on GM cars. Standard Package contains 25 shims.

250
Series

papco

DOOR HINGE PINS and BUSHINGS
GOUPILLES et BAGUES DE PORTE

'Papco' Door Hinge Pins and Bushings are replacements for original equipment hardware that has worn, been broken or damaged - causing misalignment, sagging or sticking.



250-549
250-550
250-551
250-552



250-553



250-559



250-560



250-562

Order by Stock Number

| Stock No. | Description | Std. Pkg. |
|-----------|---|-----------|
| 250-549 | (9716926) (20345137) Door Hinge Bushings .490" O.D. | 25 |
| 250-550 | (9721917) (DIAZ-6522841A) GM, Ford Door Hinge Bushing .419" O.D. | 25 |
| 250-551 | (D902-6522841A) Ford Door Hinge Bushing .479" O.D. | 25 |
| 250-552 | (4033711) Chrysler Door Hinge Bushing .316" O.D. | 25 |
| 250-553 | (20429500) GM Splined Door Hinge Bushing .489" O.D. | 25 |
| 250-559 | (6271989) (20046147) 11/32" x 4 -3/16" GM Door Hinge Pin | 2 |
| 250-560 | (20043351) 11/32" x 4" GM Door Hinge Pin | 10 |
| 250-562 | (6028993) (6032975) 17/64" x 2 -3/4" Chrysler, Vans, Door Hinge Pin | 10 |

251 Series

papeco COIL SPRINGS STABILIZERS STABILISATEURS DE RESSORT

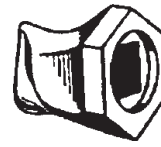

Easily installed with a 1/2" socket drive or open end wrench.
Designed to aid wheel alignment, eliminate front end dip or restore weak coil springs to original position.
Convenient skin-packed card contains four stabilizers. Order by Card Number.



ASSORTMENT DISPLAY No. 020-881

Contains 12 small and 8 large Coil Spring Stabilizers. Attractive three colour display card can be hung on wall or set on counter.

020-881

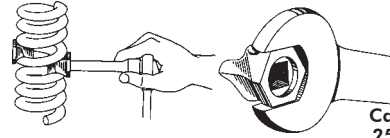

Card No. 251-042

Card No. 251-042
Contains four small type stabilizers for Front Coil Springs.

Card No. 251-044
Contains four large type stabilizers for Front or Rear Coil Springs.



Solid Rubber, Block Type Stabilizers



For front coils only.

Corrects sagging of coil springs, bottoming and side sway.

Convenient skin-packed card contains four stabilizers.

Order by Card Number.

Card No. 251-031 For front coils only.

Card No. 251-057 For rear coils only.



For rear coils springs only.

Complete installation instructions on back of each card.



Card No. 251-031

Heavy Duty Rubber Stabilizers Circular Type



For front or rear coils.

Recommended for rough road conditions and heavy duty applications such as taxis and police cars, etc.

Individually carded

Order by Card Number 251-059



Complete installation instructions included in each package.

papeco ADJUSTABLE COIL SPRING EXPANDER RELEVEURS DE RESSORT REGLABLE

Expands sagging coil springs for improved riding and steering qualities.
Convenient skin-packed card contains two expanders and complete installation instructions.



Order by Card Number 251-060.



COIL SPRING EXPANDER DISPLAY No. 020-882

Contains 12 Coil Spring Expanders. Mounted on an attractive three colour point of purchase display card. Can be hung or set on counter.

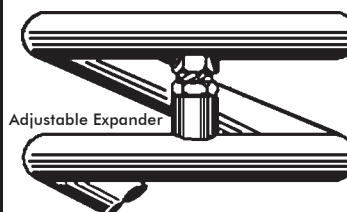

Adjustable Expander



251
Series



SPRING CENTRE BOLTS with NUTS
BOULONS DE CENTRAGE DE RESSORT avec ECROUS



BLACK FINISH

Fillister head, Universal (long) Fine Threads with Hexagon Nut
for all makes of Cars and Trucks (except Ford)

'Papco' Spring Centre Bolts are made of special steel, and are furnished with extra long threads in order to make them universal.

Order by Stock Number

Standard Package 25 Bolts and Nuts

| Stock No. | Diameter | Length | Thread Lgth. | Stock No. | Diameter | Length | Thread Lgth. |
|-----------|----------|--------|--------------|-----------|----------|--------|--------------|
| 251-110 | 5/16 | 3-1/2 | 3 | 251-128 | 3/8 | 12 | 10 |
| 251-112 | 5/16 | 5 | 4 | 251-131 | 7/16 | 4 | 3 |
| 251-114 | 5/16 | 7 | 3 | 251-132 | 7/16 | 5 | 4 |
| 251-121 | 3/8 | 4 | 3 | 251-134 | 7/16 | 7 | 5 |
| 251-122 | 3/8 | 5 | 4 | 251-136 | 7/16 | 9 | 7 |
| 251-123 | 3/8 | 6 | 5 | 251-138 | 7/16 | 12 | 10 |
| 251-124 | 3/8 | 7 | 5 | 251-145 | 1/2 | 8 | 6 |
| 251-125 | 3/8 | 8 | 6 | 251-147 | 1/2 | 10 | 6 |
| 251-127 | 3/8 | 10 | 9 | 251-148 | 1/2 | 12 | 10 |

111
Series



'POZI-LOK'® DOUBLE NUTS
ECROUS TRES HAUT 'POZI-LOK'®



These Nylon Insert, prevailing torque lock nuts offer excellent vibration resistance and assure positive locking under severe shock. Used for Spring Centre Bolts, Spring U-Bolts etc. UNF Fine Thread.

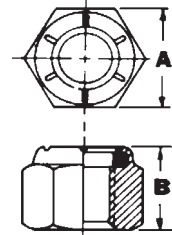

Order by Stock Number

Standard Package 5 Pieces

| Stock No. | Size | Dimensions | |
|-----------|---------|------------|---------------|
| | | Width "A" | Thickness "B" |
| 111-018 | 3/8-24 | 35/64 | 41/64 |
| 111-020 | 7/16-20 | 5/8 | 49/64 |
| 111-022 | 1/2-20 | 3/4 | 13/16 |
| 111-024 | 5/8-18 | 15/16 | 1" |

102
Series



DOUBLE THICKNESS NUTS
ECROUS TRES HAUT

(Light High Nuts)

'Papco' Double Nuts are used on spring centre bolts, spring 'U' bolts, heavy duty truck wheels, tractor and implement bolts. All Double Thickness Nuts have UNF (S.A.E.) Fine Threads.

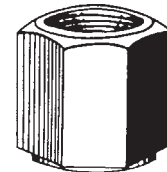

Order by Stock Number

*12 Pieces
Standard Package 24 Pieces

| Stock No. | Size | Height | Width | Stock No. | Size | Height | Width |
|-----------|---------|--------|-------|-----------|----------|----------|----------|
| 102-018 | 3/8-24 | 17/32 | 9/16 | 102-026 | 3/4-16 | 1" | 1-1/16" |
| 102-020 | 7/16-20 | 39/64 | 5/8 | 102-027 | 3/4-16 | 1" | 1-1/8" |
| 102-022 | 1/2-20 | 11/16 | 3/4 | *102-028 | 7/8-14 | 1-5/32" | 1-1/4" |
| 102-023 | 9/16-18 | 49/64 | 7/8 | *102-030 | 1-14 | 1-5/16" | 1-7/16" |
| 102-024 | 5/8-18 | 27/32 | 15/16 | *102-034 | 1-1/4-12 | 1-11/16" | 1-13/16" |

256
Series

papeco

MUFFLER CLAMPS
COLLIERS DE SILENCIEUX



- Heavy Gauge Steel
- Pipe Size stamped in clamp
- Complete coverage from 1-1/4" to 4" Pipe dia.

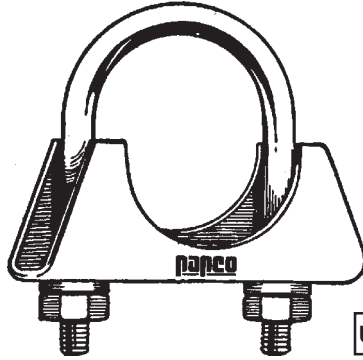

- Full depth saddle for extra strength
- Heavy rolled thread "U" Bolts
- Secure fit between tail pipe and muffler

Use for Inch and Metric applications

"Papco" Muffler Clamps provide a full 360° seal between muffler and pipes. Designed for easier installation and trouble-free service. Assembly consists of heavy gauge saddle, "U" Bolt and two nuts, packed in an individual container.

Order by Stock Number

| 5/16" Diameter "U" Bolts | | |
|--------------------------|-----------|-------------------|
| Stock No. | Pipe Size | Metric Equivalent |
| 256-010 | 1-1/4 | 32mm |
| 256-012 | 1-1/2 | 38mm |
| 256-013 | 1-5/8 | 41mm |
| 256-014 | 1-3/4 | 45mm |
| 256-015 | 1-7/8 | 48mm |
| 256-016 | 2 | 51mm |
| 256-017 | 2-1/8 | 54mm |
| 256-018 | 2-1/4 | 57mm |
| 256-020 | 2-1/2 | 64mm |

| 3/8" Diameter "U" Bolts | | |
|-------------------------|-----------|-------------------|
| Stock No. | Pipe Size | Metric Equivalent |
| 256-114 | 1-3/4 | 45mm |
| 256-115 | 1-7/8 | 48mm |
| 256-116 | 2 | 51mm |
| 256-117 | 2-1/8 | 54mm |
| 256-118 | 2-1/4 | 57mm |
| 256-120 | 2-1/2 | 64mm |
| 256-124 | 3 | 76mm |
| 256-128 | 3-1/2 | 89mm |
| 256-132 | 4 | 102mm |

papeco **UNIVERSAL TAILPIPE BRACKETS**
SUPPORT UNIVERSEL DE TUYAU
D' ECHOPPEMENT

Used to suspend exhaust system components such as mufflers, catalytic converters and tailpipes. Brackets No. 256-002 and 256-003 are used with muffler clamps.

Individually Packaged
Order by Stock Number

| Stock No. | Size & Description |
|-----------|--------------------------------------|
| 256-001 | 6" Steel Strap 1-1/2 - 2-1/2 OD Pipe |
| 256-002 | 4" Rubber Strap - 4 holes |
| 256-003 | 7" Steel Strap Swivel end |

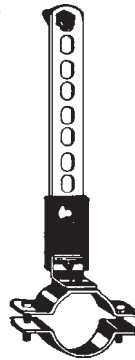

256-001



256-002



256-003



papeco **EXHAUST SYSTEM**
FASTENERS ASSORTMENTS

MASTER ASSORTMENT No. 020-639

Contains Cap Screws, Carriage Bolts, Brass and Steel Engine Stud Nuts and Finished Hex Nuts. Gives complete coverage of the most common Exhaust System Fasteners. Sizes and quantities based on popularity.

MASTER ASSORTMENT No. 020-632

Contains manifold studs and brass nuts. For complete listing, see next page.



264
Series

papco

ENGINE STUDS and NUTS
GOUJONS et ECROUS DE MOTEUR

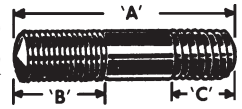

'Papco' Engine Studs will service all popular makes of cars. They have extra long threads and can be cut to size where a shorter stud is required.

Order by Stock Number

Standard Packages 12 pieces

| Stock No. | Length Dia. x 'A' | Dimensions | | Stock No. | Length Dia. x 'A' | Dimensions | |
|-----------|-------------------|------------|---------|-----------|-------------------|------------|---------|
| | | 'B' | 'C' | | | 'B' | 'C' |
| 264-016 | 5/16 x 1-3/4 | 7/8 UNF | 5/8 UNC | 264-092 | 7/16 X 2-1/4 | 7/8 UNF | 7/8 UNC |
| 264-018 | 5/16 x 2 | 7/8 UNF | 3/4 UNC | 264-094 | 7/16 X 2-3/8 | 7/8 UNF | 5/8 UNC |
| 264-024 | 5/16 x 2-1/2 | 1-1/2 UNF | 1/2 UNC | 264-096 | 7/16 X 2-1/2 | 7/8 UNF | 3/4 UNC |
| 264-032 | 5/16 x 3 | 1-1/2 UNF | 5/8 UNC | 264-102 | 7/16 X 3-1/4 | 1-7/8 UNF | 5/8 UNC |
| 264-048 | 3/8 x 2 | 1 UNF | 3/4 UNC | 264-103 | 7/16 X 3-1/4 | 1 UNF | 3/4 UNC |
| 264-049 | 3/8 x 2 | 1 UNC | 5/8 UNC | 264-108 | 7/16 X 3-5/8 | 1-3/4 UNF | 5/8 UNC |
| 264-058 | 3/8 x 2-3/4 | 1 UNF | 3/4 UNC | 264-110 | 7/16 X 4 | 1-7/8 UNF | 5/8 UNF |
| 264-060 | 3/8 x 3 | 1-1/4 UNF | 3/4 UNC | 264-134 | 1/2 X 2-1/2 | 1 UNF | 3/4 UNC |
| 264-066 | 3/8 x 4 | 2 UNC | 3/4 UNC | 264-140 | 1/2 X 2-7/8 | 7/8 UNF | 3/4 UNC |
| 264-067 | 3/8 x 4 | 2 UNF | 3/4 UNC | 264-150 | 1/2 X 4 | 2 UNF | 3/4 UNC |
| 264-086 | 7/16 x 1-3/4 | 9/16 UNF | 1/2 UNC | | | | |
| 264-088 | 7/16 x 2 | 7/8 UNF | 3/4 UNC | | | | |

METRIC STUDS

Conform to I.S.O. Class 8.8 Specifications. For manifolds, rocker covers and general engine uses.

For Metric Steel Nuts see page 25.

Standard Package 10 Studs

| Stock No. | Dia. x Pitch x Length 'A' | 'B' mm | 'C' mm | Application | Stock No. | Dia. x Pitch x Length 'A' | 'B' mm | 'C' mm | Application |
|-----------|---------------------------|--------|--------|------------------|-----------|-------------------------------|---------|----------|----------------|
| 264-230 | M6 x 1.00 x 30mm | 14 | 12 | VW-056-103-400 | 264-440 | M8 x 1.25 / M10 x 1.50 x 35mm | 14 (M8) | 19 (M10) | Universal |
| 264-328 | M8 x 1.25 x 28mm | 15 | 10 | VWN044-511-1 | 264-441 | M10 x 1.25 x 37mm | 13 | 21 | Universal |
| 264-335 | M8 x 1.25 x 35mm | 17 | 12 | VWN044-514-2 | 264-443 | M10 x 1.25 x 43mm | 21 | 16 | DAT14064-N4200 |
| 264-338 | M8 x 1.25 x 38mm | 20 | 10 | VWN14-443-8 | 264-450 | M10 x 1.25 x 50mm | 25 | 15 | Universal |
| 264-346 | M8 x 1.25 x 46mm | 23 | 16 | VWN044-410-2(-4) | 264-451 | M10 x 1.50 x 50mm | 25 | 15 | Universal |
| 264-348 | M8 x 1.25 x 50mm | 23 | 10 | Universal | 264-452 | M10 x 1.50 x 52mm | 27 | 12 | Universal |
| 264-350 | M8 x 1.25 x 55mm | 23 | 10 | Universal | 264-453 | M10 x 1.50 x 62mm | 28 | 12 | Universal |
| 264-352 | M8 x 1.25 x 60mm | 24 | 10 | Universal | 264-455 | M10 x 1.50 x 65mm | 46.5 | 13.5 | Universal |
| 264-354 | M8 x 1.25 x 65mm | 19 | 10 | Universal | 264-457 | M10 x 1.50 x 77mm | 28 | 12 | Universal |
| 264-356 | M8 x 1.25 x 70mm | 24 | 10 | Universal | | | | | |



HEX BRASS NUTS

| Stock No. | Size and Thread | Width Across Flats | Thickness |
|-----------|-----------------|--------------------|-----------|
| 264-953 | 5/16 UNF | 1/2 | 17/64 |
| 264-954 | 5/16 UNC | 1/2 | 17/64 |
| 264-955 | 3/8 UNF | 9/16 | 21/64 |
| 264-956 | 3/8 UNC | 9/16 | 21/64 |
| 264-957 | 3/8 UNC | 9/16 | 5/8 |
| 264-958 | 7/16 UNF | 5/8 | 3/8 |
| 264-959 | 7/16 UNC | 5/8 | 3/8 |
| 264-960 | 1/2 UNF | 3/4 | 7/16 |
| 264-961 | 1/2 UNC | 3/4 | 7/16 |

ENGINE STUD and NUT MASTER ASSORTMENT No. 020-632

Contains 80 pieces - 10 sizes.

Will service all exhaust manifold applications. Complete car coverage. All Parts illustrated on hinged lid of sturdy metal merchandiser. Handy carrying handle with snap lock.

HIGH STRENGTH STEEL NUTS

Standard Package 25 Nuts

| Stock No. | Size and Thread | Width Across Flats | Thickness |
|-----------|-----------------|--------------------|-----------|
| 264-903 | 5/16 UNF | 1/2 | 17/64 |
| 264-905 | 3/8 UNF | 9/16 | 21/64 |
| 264-908 | 7/16 UNF | 11/16 | 3/8 |
| 264-909 | 7/16 UNC | 11/16 | 3/8 |
| 264-910 | 1/2 UNF | 3/4 | 7/16 |

For 'Papcolloy' Hardened Steel Washers see page 32.

For SUPER-SERVICE ASSORTMENT No. 020-818 Engine Studs and Nuts see page 9.

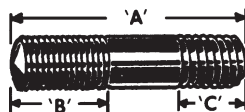
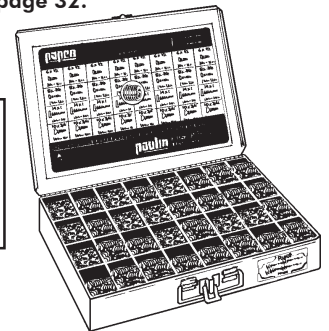

papco

MANIFOLD STUDS
GOUJONS POUR COLLECTEUR

LOW CARBON STEEL

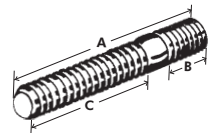

'Papco' Low - Carbon Manifold Studs are easily removed if rusted, broken or stripped. Simply drill out or burn out with a torch. Preferred by muffler shops everywhere. Coarse thread both ends.

Order by Stock Number

Standard Packages 10 pieces

| Stock No. | Dia. x Length 'A' | Dimensions | | Stock No. | Dia. x Length 'A' | Dimensions | |
|-----------|-------------------|------------|----------|-----------|-------------------|------------|-------|
| | | 'B' | 'C' | | | 'B' | 'C' |
| 264-504 | 3/8-16 x 2 | 5/8 NC | 1-1/8 NC | 264-519 | 7/16-14 x 3 | 5/8 NC | 2" NC |
| 264-507 | 3/8-16 x 2-1/2 | 5/8 NC | 1-1/4 NC | 264-523 | 7/16-14 x 4 | 5/8 NC | 2" NC |
| 264-509 | 3/8-16 x 3 | 5/8 NC | 2" NC | 264-640 | M8 x 1.25 x 40 | 16mm | 19mm |
| 264-510 | 3/8-16 x 3-1/4 | 5/8 NC | 1-5/8 NC | 264-650 | M10 x 1.5 x 50 | 16mm | 19mm |
| 264-517 | 7/16-14 x 2-1/2 | 5/8 NC | 1-1/4 NC | | | | |

257
Series



CYLINDER HEAD BOLT KITS
TROUSE POUR BOULONS DE CULASSE



'Papeco' Cylinder Head Bolts are made of high-strength Grade 8 steel. Original bolts may be permanently stretched when torqued to specifications and should be replaced. Torque-to-yield bolts **MUST** be replaced to avoid premature head gasket failure.

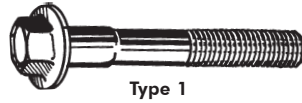

Type 1

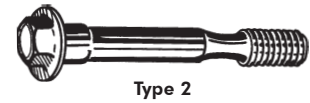

Type 2



Type 3



Type 4

Order by Kit Number

| Type | Year | Cyl. | Engine Size | Size | Kit No. | Trq. to Yeild | Pcs. /Kit | Factory No. | |
|-----------------------|---------|-------|---|------------------|-------------------|----------------|-----------|-------------|-------------------|
| CHRYSLER | | | | | | | | | |
| 1 | 1981-up | (4) | 2.2L (135), 2.5L (153) | M11 X 1.5 X 120 | 257-301 | Yes | 10 | 6501433 | |
| 1† | 1987-up | (6) | 3.0L (181) SOHC (Mits.) | M12 X 1.25 X 102 | 257-303 | Yes | 16 | MD065959 | |
| 1 | 1993-up | (6) | 3.5L | 1/2-13 X 1-7/8 | 257-304 | Yes | 16 | 6502665 | |
| 1 | 1957-up | (8) | All | (Short) | 1/2-13 X 3-5/8 | 257-305 | No | 10 | 6031045 |
| 1 | | | | (Medium) | 1/2-13 X 4-1/2 | | No | 8 | 6031101 |
| 1 | | | | (Long) | M11 X 1.5 X 190 | | No | 2 | 2463260 |
| FORD | | | | | | | | | |
| 1 | 1981-94 | (4) | 1.6L, 1.9L Escort | M10 X 1.5 X 130 | 257-310 | Yes | 10 | E4FZ-6065-A | |
| 1 | 1974-95 | (4) | 2.3L (140), OHC | M12 X 1.75 X 100 | 257-311 | No | 10 | D4FZ-6065-A | |
| 1 | 1986-up | (6) | 2.9L (177), 4.0L (244) Truck | M12 X 1.75 X 73 | 257-312 | Yes | 16 | E6TZ-6065-A | |
| 1 | 1986-up | (6) | 3.0L (183) Exc: SHO | M11 X 1.5 X 102 | 257-313 | Yes | 16 | E8DZ-6065-A | |
| 2 | 1982-up | (6) | 3.8L (232) | (Short) | M11 X 1.5 X 80 | 257-315 | Yes | 8 | F4SZ-6065-B |
| 2 | | | | (Long) | M11 X 1.5 X 100 | | Yes | 8 | F4SZ-6065-A |
| 1 | 1991-up | (8) | 4.6L (281) SOHC | M11 X 1.5 X 210 | 257-316 | Yes | 20 | F5AZ-6065-A | |
| 2 | 1980-95 | (8) | 4.9L (300) | 7/16-14 X 4 | 257-317 | Yes | 14 | F3ZZ-6065-B | |
| 2 | 1970-up | (8) | 5.0L (302) | (Long) | 7/16-14 X 4 | 257-318 | Yes | 10 | F3ZZ-6065-B |
| 2 | | | | (Short) | 7/16-14 X 2-7/16 | | Yes | 8 | F3ZZ-6065-C |
| 4 | | | | (w/stud) | 7/16-14 X 3-7/8 | | Yes | 2 | F3ZZ-6065-D |
| 3 | 1970-up | (8) | 5.8L (351) Windsor | (Short) | 1/2-13 X 2-1/2 | 257-319 | No | 20 | C902-6065-A |
| 3 | | | | (Long) | 1/2-13 X 4 | | No | 20 | C902-6065-B |
| GENERAL MOTORS | | | | | | | | | |
| 1 | 1985-95 | (4) | 1.6L (98) 4, 5, 6 Geo | M10 X 1.5 X 94 | 257-331 | Yes | 10 | 96061591 | |
| 3 | 1982-94 | (4) | 1.8L, 2.0L, OHC H, K, M | (w/stud) | M11 X 1.5 X 140 | 257-332 | Yes | 2 | 10031210 |
| 4 | | | | (w/stud) | M11 X 1.5 X 185 | | Yes | 4 | 10031213 |
| 4 | | | | (w/stud) | M11 X 1.5 X 165 | | Yes | 4 | 10031214 |
| 1 | 1987-93 | (4) | 2.3L (138) QUAD IV DOHC | (Long) | M12 X 1.75 X 83 | 257-334 | Yes | 2 | 22531281 |
| 1 | | | | (Long) | M12 X 1.75 X 98 | | Yes | 8 | 22531282 |
| 4 | 1980-up | (4) | 2.5L (151) A, E, 5, R, 2 (w/stud) | (w/stud) | M11 X 1.5 X 125 | 257-336 | Yes | 1 | 12338010 |
| 4 | | | | (w/stud) | M11 X 1.5 X 99 | | Yes | 1 | 12338012 |
| 1 | | | | (w/stud) | M11 X 1.5 X 99 | | Yes | 8 | 12337818 |
| 1 | 1987-96 | (6) | 2.8L (173) W, 3.1L (189) VIN T | | M11 X 1.5 X 78 ** | 257-338 | Yes | 8 | 10100033 |
| 1 | | | | | M11 X 1.5 X 108 | | Yes | 8 | 10227593 |
| 1 | 1982-95 | (6) | 2.8L (173), 3.1L (189) M, T, W | | M11 X 1.5 X 68 | 257-339 | No | 8 | 476572 |
| 1 | | | | | M11 X 1.5 X 93 | | No | 8 | 476543 |
| 3 | 1975-up | (6) | 3.8L (231) A, B, G, 2, 3, 7, 8, 9, C, L | | 7/16-14 X 2-11/16 | 257-340 | No | 8 | 1243262 |
| 1 | | | | | 7/16-14 X 3-1/2 | | No | 8 | 1253539 |
| 3 | 1955-up | (6-8) | 4.3L (262) Z, 305, 327, 350, 400 | | 7/16-14 X 3-3/4 * | 257-341 | No | 14 | 14082317 |
| 3 | | | | | 7/16-14 X 1-3/4 * | | No | 16 | 14082316 |
| 3 | | | | | 7/16-14 X 3 * | | No | 4 | 14082315 |
| 1 | 1982-up | (8) | 6.2L (381), 6.5L (395) Diesel | 7/16-14 X 3 | 257-342 | No | 34 | 14077193 | |
| 1 | 1971-up | (8) | 366, 427, 454 Truck | (Long) | 7/16 X 4-5/64 | 257-343 | No | 8 | 10141204, 3877668 |
| 1 | | | | (Short) | 7/16 X 2-1/16 | | No | 24 | 10141205, 3877669 |

† Round Head

* with GM 9985490 Thread Sealant

** with GM 6124M Thread Sealant

257
Series



STARTER BOLTS
BOULONS A DEMARREUR

These hexagon washer head medium carbon steel plated bolts are replacements for damaged or missing starter mounting bolts.

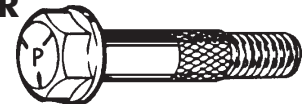

Order by Stock Number

Standard Package 5 Pieces

| Stock No. | Size | Application | Stock No. | Size | Application |
|----------------|-----------------|------------------------|----------------|-----------------|---------------------------------------|
| 257-005 | 3/8-16 x 1-5/16 | GM 4.4, 5.0 & 5.7 lit. | 257-055 | M10 x 1.5 x 45 | GM 2.0, 2.5 & 3.4 lit. |
| 257-007 | 3/8-16 x 1-7/8 | GM 3.8 lit., 6 cyl. | 257-060 | M10 x 1.5 x 102 | GM 2.8 & 3.1 lit. |
| 257-012 | 3/8-16 x 3-5/8 | GM 6 & 8 cyl. | 257-065 | M10 x 1.5 x 113 | GM 2.0, 2.5 & 3.4 lit. |
| 257-015 | 3/8-16 x 4-5/16 | GM 4.4, 5.0 & 5.7 lit. | 257-070 | M10 x 1.5 x 118 | GM 2.0, 2.2, 2.5, 2.8, 3.1 & 3.4 lit. |
| 257-017 | 3/8-16 x 4-1/2 | GM 4.3 & 5.0 lit. | | | |
| 257-018 | 3/8-16 x 4-5/8 | GM 5.0 & 5.7 lit. | | | |



257
Series

PAPCO ALTERNATOR BOLTS BOULONS DE ALTERNATEUR

These high-strength, heat treated plated bolts are used as alternator mounting bolts on domestic and imported vehicles.



Order by Stock Number

Standard Package 5 Pieces

| Stock No. | Size | Application | Stock No. | Size | Application |
|-----------|-----------------|-------------|-----------|-----------------|-------------|
| 257-105 | 5/16-18 x 1-1/4 | Universal | 257-120 | 3/8-16 x 6 | GM |
| 257-110 | 5/16-18 x 5 | GM | 257-125 | 7/16-14 x 5-1/2 | Ford |
| 257-115 | 3/8-16 x 3-1/8 | GM | 257-155 | M10 x 1.5 x 80 | GM |
| 257-118 | 3/8-16 x 4 | Chrysler | 257-160 | M10 x 1.5 x 105 | GM |

263
Series

PAPCO DRAIN COCKS ROBINETS DE VIDANGE

'Papco' Plastic Drain Cocks for low pressure applications. For water, air, gas, anti-freeze and other fluids. (Not intended for natural gas, LPG or lubricants.)

Order by Stock Number

Standard Package 5 Pieces

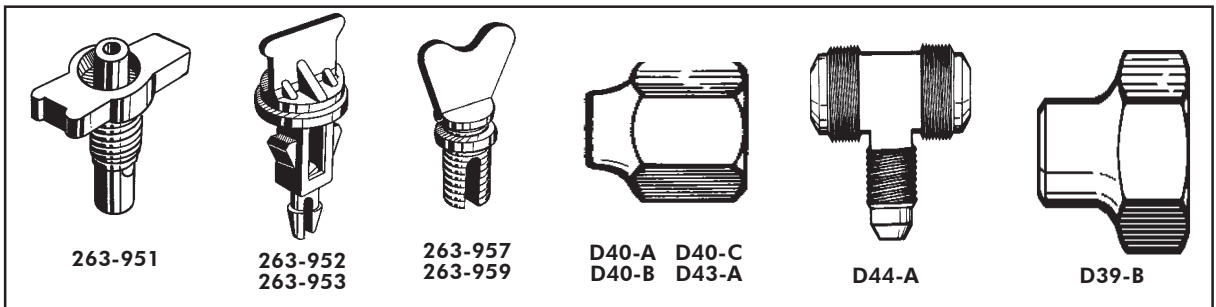

| PLASTIC DRAIN COCKS | | | BRASS DRAIN COCKS | | |
|---------------------|----------------|---|-------------------|-----------|------------------|
| Stock No. | Size | Factory No. Appl. | Stock No. | Pipe Size | Type |
| 263-951 | 5/16 (7/16-20) | GM: 3042160 | D40-A | 1/8 | Back Seating |
| 263-952 | 1/4x1-1/2 | GM: 305104 FORD: E1FZ-8115A | D40-B | 1/4 | Back Seating |
| 263-953 | 1/4x1-7/8 | FORD: E57H-B115A | D40-C | 3/8 | Back Seating |
| 263-957 | 10mm x 1.25 | NISSAN: 21480-RD100 SUBARU: 7451-24010 | D43-A | 1/8 | Outlet Fitting |
| 263-959 | 14mm x 1.25 | TOYOTA: 90910-09054 HONDA: 19011-PA004 | D44-A | 1/8 | Outlet Fitting |
| | | | D39-B | 1/4 | External Seating |

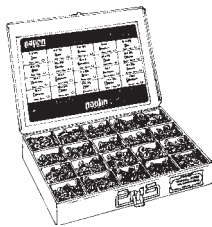

DRAIN COCK MASTER ASSORTMENT No. 020-606

Contains 119 pieces of Plastic and Brass Drain Cocks - plus Compression Sleeves, Nuts, Unions and four sizes of Hex Head Pipe Plugs.

- All Metal box with hinged lid and handy carrying handle.
- Plastic, moulded compartmentized tray.
- Illustrated lid label with retail price codes and refill stock numbers.

DRUM FAUCET No. 913-026

Individually Packaged

For use with oils, kerosene, gasoline, naphtha, alcohol, lacquers, varnishes, thinners, solvents of all kinds, anti-freeze solutions and other liquids, hot or cold.

The 'Papco' Sette Faucet is simple in design and has an all nylon seat for extended life.

Extra thin liquids that are impossible to hold with ordinary faucets are held absolutely and permanently tight by 'Papco' Sette Faucets.

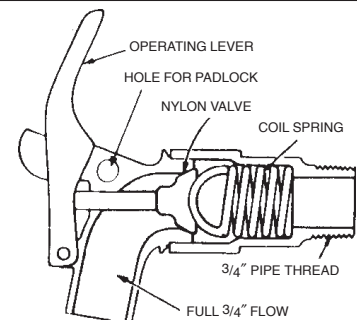



Also known as Frost Plugs, Welsh Plugs or Freeze-Out Plugs.
"Papco" Expansion Plugs are made of heavy gauge plated steel or solid brass to resist rust.

Aussi connus "Frost Plugs", "Welsh Plugs", "Freeze-Out Plugs".
Les bouchons d'expansion "Papco" sont fabriqués d'acier épais et plaqués ou laiton massif pour résister à la rouille.



STANDARD TYPE / TYPE REGULIER

Standard Package / Contenant Régulier: 3/8-15/8 = 25 pcs. 147/64-3 = 12 pcs.

| Stock No. STEEL | Stock No. BRASS | Nominal Plug Size | Reference O.D. +/- .005 | Stock No. STEEL | Stock No. BRASS | Nominal Plug Size | Reference O.D. +/- .005 |
|-----------------|-----------------|-------------------|-------------------------|-----------------|-----------------|-------------------|-------------------------|
| 260-006 | 260-506 | 3/8 | .375 | 260-042 | | 1 5/16 | 1.313 |
| 260-008 | | 7/16 | .437 | 260-045 | 260-545 | 1 3/8 | 1.375 |
| 260-010 | 260-510 | 1/2 | .500 | 260-048 | | 1 7/16 | 1.437 |
| 260-012 | | 9/16 | .563 | 260-051 | | 1 31/64 | 1.484 |
| 260-014 | | 5/8 | .625 | 260-054 | | 1 1/2 | 1.500 |
| 260-016 | | 11/16 | .687 | 260-057 | 260-557 | 1 5/8 | 1.625 |
| 260-018 | 260-518 | 3/4 | .750 | 260-060 | | 1 47/64 | 1.734 |
| 260-020 | | 13/16 | .812 | 260-063 | 260-563 | 1 3/4 | 1.750 |
| 260-022 | | 27/32 | .844 | 260-066 | 260-566 | 1 7/8 | 1.875 |
| 260-024 | 260-524 | 7/8 | .875 | 260-069 | 260-569 | 2 | 2.000 |
| 260-026 | | 15/16 | .936 | 260-072 | | 2 1/16 | 2.063 |
| 260-028 | 260-528 | 1 | 1.000 | 260-075 | 260-575 | 2 7/64 | 2.105 |
| 260-030 | | 1 1/32 | 1.031 | 260-078 | | 2 1/4 | 2.250 |
| 260-032 | | 1 1/16 | 1.063 | 260-081 | | 2 1/2 | 2.500 |
| 260-034 | 260-534 | 1 1/8 | 1.125 | 260-084 | | 2 3/4 | 2.750 |
| 260-036 | | 1 3/16 | 1.188 | 260-087 | | 3 | 3.000 |
| 260-039 | 260-539 | 1 1/4 | 1.250 | | | | |

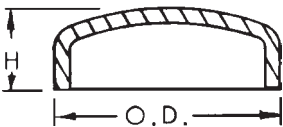

Plated Steel or Solid Brass/ Acier Plaqué ou laiton massif
CUP TYPE / TYPE D'ASSIETTE

Standard Package / Contenant Régulier = 12 pcs.

| Stock No. STEEL | Stock No. BRASS | Nominal Plug Size | Reference O.D. +/- .005 | H - Overall Height | Stock No. STEEL | Stock No. BRASS | Nominal Plug Size | Reference O.D. +/- .005 | H - Overall Height |
|-----------------|-----------------|-------------------|-------------------------|--------------------|-----------------|-----------------|-------------------|-------------------------|--------------------|
| 260-103 | | 5/16 | .3135 | .296 | 260-174 | | 1 1/2 | 1.522 | .375 |
| 260-108 | | 7/16 | .450 | .210 | 260-177 | | 1 1/2 | 1.506 | .325 |
| 260-110 | | 7/16 | .4445 | .156 | 260-180 | 260-680 | 1 1/2 | 1.5075 | .625 |
| 260-112 | | 29/64 | .460 | .270 | 260-183 | | 1 9/16 | 1.576 | .600 |
| 260-114 | | 1/2 | .527 | .312 | 260-186 | 260-686 | 1 5/8 | 1.6375 | .593 |
| 260-115 | | 1/2 | .511 | .258 | 260-189 | | 1 41/64 | 1.642 | .350 |
| 260-116 | | 35/64 | .5425 | .250 | 260-192 | | 1 45/64 | 1.7075 | .812 |
| 260-118 | | 9/16 | .583 | .250 | 260-194 | 260-694 | 1 3/4 | 1.7625 | .363 |
| 260-120 | | 19/32 | .594 | .281 | 260-198 | 260-698 | 1 3/4 | 1.7625 | .593 |
| 260-124 | | 5/8 | .640 | .250 | 260-204 | | 1 3/4 | 1.750 | .356 |
| 260-126 | | 5/8 | .6325 | .250 | 260-207 | 260-707 | 1 49/64 | 1.7655 | .406 |
| 260-128 | | 11/16 | .700 | .250 | 260-210 | 260-710 | 1 7/8 | 1.8925 | .447 |
| 260-130 | 260-630 | 3/4 | .7525 | .250 | 260-213 | | 1 57/64 | 1.883 | .266 |
| 260-132 | | 3/4 | .7625 | .265 | 260-216 | | 1 29/32 | 1.902 | .600 |
| 260-134 | | 13/16 | .812 | .312 | 260-219 | 260-719 | 1 15/16 | 1.9475 | .800 |
| 260-136 | | 7/8 | .888 | .312 | 260-222 | 260-722 | 1 61/64 | 1.9555 | .300 |
| 260-138 | 260-638 | 29/32 | .912 | .390 | 260-225 | | 1 63/64 | 2.000 | .800 |
| 260-140 | 260-640 | 59/64 | .925 | .335 | 260-228 | 260-728 | 2 | 2.009 | .635 |
| 260-142 | | 15/16 | .945 | .375 | 260-231 | | 2 | 2.008 | .415 |
| 260-144 | 260-644 | 1 | 1.014 | .281 | 260-234 | 260-734 | 2 1/64 | 2.0175 | .590 |
| 260-147 | | 1 5/64 | 1.072 | .280 | 260-237 | 260-737 | 2 1/16 | 2.0675 | .510 |
| 260-150 | 260-650 | 1 1/8 | 1.133 | .437 | 260-240 | | 2 3/32 | 2.0975 | .610 |
| 260-153 | | 1 13/64 | 1.200 | .420 | 260-243 | 260-743 | 2 1/8 | 2.145 | .430 |
| 260-156 | | 1 7/32 | 1.228 | .531 | 260-246 | | 2 9/64 | 2.1485 | .600 |
| 260-159 | 260-659 | 1 1/4 | 1.255 | .300 | 260-249 | | 2 3/16 | 2.199 | .360 |
| *260-162 | | 1 1/4 | 1.2575 | .343 | 260-252 | 260-752 | 2 1/4 | 2.265 | .812 |
| 260-165 | | 1 1/4 | 1.258 | .437 | *260-255 | | 2 17/64 | 2.264 | .355 |
| 260-168 | | 1 3/8 | 1.3875 | .500 | 260-260 | | 2 1/2 | 2.504 | .350 |
| 260-171 | | 1 7/16 | 1.438 | .431 | *260-262 | | 2 1/2 | 2.500 | .340 |

*With Reverse Taper



260
Series

papco EXPANSION PLUGS
BOUCHONS D'EXPANSION

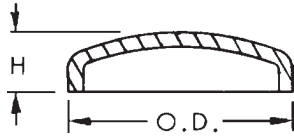

Plated Steel or Solid Brass / Acier plaqué ou laiton massif
SHALLOW CUP TYPE / TYPE D'ASSIETTE PEU PROFOND
Standard Package / Contenant Régulier = 12 pcs.

| Stock No. STEEL | Stock No. BRASS | Nominal Plug Size | Reference O.D. +/- .005 | H - Overall Height | Stock No. STEEL | Stock No. BRASS | Nominal Plug Size | Reference O.D. +/- .005 | H - Overall Height |
|-----------------|-----------------|-------------------|-------------------------|--------------------|---------------------|-----------------|-------------------|-------------------------|--------------------|
| 260-303 | 260-803 | 7/16 | .440 | .170 | 260-348 | | 1 29/32 | 1.915 | .265 |
| 260-305 | | 29/64 | .450 | .203 | 260-351 | | 1 59/64 | 1.922 | .235 |
| 260-307 | | 1/2 | .505 | .250 | 260-354 | | 1 31/32 | 1.9775 | .218 |
| 260-309 | | 35/64 | .5425 | .187 | 260-357 | | 2 | 2.025 | .406 |
| 260-311 | | 5/8 | .631 | .190 | 260-359 | 260-859 | 2 | 2.010 | .310 |
| 260-313 | | 53/64 | .8235 | .250 | 260-362 | | 2 1/64 | 2.0175 | .240 |
| 260-315 | 260-815 | 1 | 1.010 | .290 | 260-365 | 260-865 | 2 1/16 | 2.0725 | .343 |
| 260-318 | 260-818 | 1 1/4 | 1.2625 | .312 | 260-372 | | 2 7/64 | 2.109 | .310 |
| 260-321 | | 1 21/64 | 1.3225 | .281 | 260-375 | | 2 9/64 | 2.135 | .360 |
| 260-324 | 260-824 | 1 3/8 | 1.385 | .340 | 260-378 | | 2 5/32 | 2.1535 | .328 |
| 260-327 | 260-827 | 1 1/2 | 1.505 | .300 | 260-381 | 260-881 | 2 3/16 | 2.200 | .355 |
| 260-330 | | 1 9/16 | 1.570 | .315 | 260-383 | | 2 3/16 | 2.192 | .343 |
| 260-333 | 260-833 | 1 5/8 | 1.640 | .345 | 260-385 | | 2 7/32 | 2.2205 | .305 |
| 260-336 | | 1 45/64 | 1.703 | .281 | 260-388 | | 2 1/4 | 2.262 | .350 |
| 260-339 | 260-839 | 1 3/4 | 1.762 | .232 | 260-391 | | 2 3/8 | 2.385 | .312 |
| 260-342 | | 1 51/64 | 1.8025 | .250 | *260-394 | | 2 9/16 | 2.575 | .301 |
| 260-345 | | 1 53/64 | 1.825 | .350 | *With Reverse Taper | | | | |

261
Series

papco METRIC EXPANSION PLUGS
BOUCHONS D'EXPANSION METRIQUE



Plated Steel/
Acier Plaqué

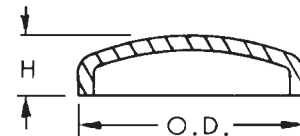

STANDARD TYPE / TYPE REGULIER

Standard Package / Contenant Régulier = 10 pcs.

| Stock No. | Nominal O.D. | Stock No. | Nominal O.D. |
|-----------|--------------|-----------|--------------|
| 261-011 | 16 mm | 261-064 | 40 mm |
| 261-014 | 18 mm | 261-069 | 42 mm |
| 261-024 | 24 mm | 261-077 | 45 mm |
| 261-026 | 25 mm | 261-090 | 52 mm |
| 261-046 | 35 mm | 261-096 | 55 mm |

SHALLOW CUP TYPE / TYPE D'ASSIETTE PEU PROFOND

Standard Package / Contenant Régulier = 10 pcs.

| Stock No. | Nominal O.D. | Stock No. | Nominal O.D. |
|-----------|--------------|-----------|--------------|
| 261-326 | 25 mm | 261-367 | 41.5mm |
| 261-347 | 35 mm | 261-377 | 45 mm |
| 261-364 | 40 mm | | |

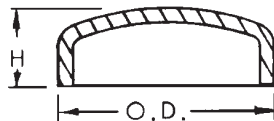

CUP TYPE / TYPE D'ASSIETTE

Standard Package / Contenant Régulier = 10 pcs.

| Stock No. | Nominal O.D. | H - Nominal Height (mm) | Stock No. | Nominal O.D. | H - Nominal Height (mm) |
|-----------|--------------|-------------------------|-----------|--------------|-------------------------|
| 261-100 | 8 mm | 4.2 | 261-149 | 36 mm | 8.5 |
| 261-103 | 11 mm | 4.85 | 261-150 | 36.5 mm | 9.0 |
| 261-105 | 12 mm | 5.3 | 261-152 | 37 mm | 10.6 |
| 261-107 | 14 mm | 5.0 | 261-155 | 38 mm | 7.9 |
| 261-108 | 14.4 mm | 5.5 | 261-158 | 39 mm | 9.5 |
| 261-109 | 15 mm | 5.5 | 261-161 | 40 mm | 11.7 |
| 261-111 | 16 mm | 9.1 | 261-162 | 40 mm | 12.8 |
| 261-114 | 18 mm | 5.9 | 261-165 | 41 mm | 11.9 |
| 261-117 | 20 mm | 7.0 | 261-170 | 42.3 mm | 10.0 |
| 261-121 | 22 mm | 7.5 | 261-171 | 42.6 mm | 10.0 |
| 261-124 | 24 mm | 6.9 | 261-173 | 44 mm | 11.9 |
| 261-126 | 25 mm | 8.3 | 261-177 | 45 mm | 11.9 |
| 261-129 | 27 mm | 8.4 | 261-178 | 45 mm | 13.5 |
| 261-132 | 28 mm | 8.7 | 261-181 | 47 mm | 7.4 |
| 261-135 | 29 mm | 11.4 | 261-182 | 48 mm | 11.7 |
| 261-138 | 30 mm | 8.1 | 261-184 | 49.5 mm | 11.0 |
| 261-140 | 31.5 mm | 8.5 | 261-185 | 50 mm | 12.0 |
| 261-142 | 32 mm | 9.5 | 261-186 | 50 mm | 14.8 |
| 261-145 | 34 mm | 12.7 | 261-188 | 51 mm | 5.55 |
| 261-146 | 35 mm | 10.6 | | | |

For applications of 'Papco' Expansion Plugs see current catalogue.



260
Series

papeco[®]



STEEL EXPANSION PLUG KITS TROUSSE DE BOUCHON DE ACIER D'EXPANSION

DOMESTIC • IMPORTS • TRUCKS • MARINE

A time-saving kit for machine shops, engine rebuilders and jobbers. Expansion plugs for each engine skin-packed in one convenient package. Coverage for Domestic and Import engines.

DOMESTIQUES • IMPORTÉS • CAMIONS • MARINE

Une trousse qui épargne du temps aux ateliers de mécanique, reconstruc-teurs de moteurs et revendeurs. Les bouchons d'expansion sont emballés sous un emballage moulant pratique. Ils servent aux moteurs domestiques et importés.

| Year | Cyl. | Application | Kit No. | Year | Cyl. | Application | Kit No. |
|-------------------|--|-------------|----------------|-------------------------|---|-------------|----------------|
| AMC | | | | CHRYSLER/ DODGE | | | |
| 1984-87 | (V6) 173 (2.8L) | | 260-407 | 1985-up | (4) 92Q (1.5L) | | 260-436 |
| 1987-97 | (V6) 244 (4.0L) | | 260-401 | 1981-96 | (4) 135 (2.2L) OHC, 153 (2.5L) OHC | | 260-434 |
| 1971-91 | (V6) 258 (4.2L) | | 260-402 | 1981-91 | (4) 156 (2.6L) Mitsubishi | | 260-435 |
| 1970-93 | (V8) 360 (5.9L) | | 260-403 | 1988-96 | (V6) 183 (3.0L) | | 260-430 |
| BUICK | | | | 1990-96 | (V6) 201 (3.3L) | | 260-436 |
| 1982-89 | (4) 112J,O (1.8L), 121 (2.0L) | | 260-418 | 1987-96 | (V6) 238 (3.9L) | | 260-430 |
| 1980-93 | (4) 151 (2.5L) | | 260-400 | 1957-96 | (V8) 318 (5.2L), 340 (5.6L), 360 (5.9L) | | 260-432 |
| 1980-93 | (V6) 173W,X,Y,Z (2.8L) | | 260-407 | FORD/ FORD TRUCK | | | |
| 1982-96 | (V6) 181E,L (3.0L) 231A,B,G,2,3,7,8,9 (3.8L) | | 260-406 | 1981-96 | (4) 98 (1.6L) Escort, 116 (1.9L) | | 260-443 |
| 1982-85 | (V6) 252 (4.1L), 260 (4.3L) Diesel | | 260-410 | 1974-94 | (4) 140 (2.3L) OHC | | 260-446 |
| 1977-93 | (V8) 305 (5.0L) | | 260-425 | 1986-96 | (V6) 183 (3.0L) | | 260-448 |
| 1980-91 | (V8) 307Y (5.0L), 260 (4.3L) Diesel, 350N Diesel (5.7L) | | 260-413 | 1982-96 | (V6) 230 (3.8L) | | 260-442 |
| CADILLAC | | | | 1991-96 | (V6) 244 OHV | | 260-452 |
| 1983-91 | (4) 121 (2.0L) I,B,P | | 260-418 | 1980-96 | (V6) 300 (4.9L), 300LD | | 260-450 |
| 1985 | (V6) 260 (4.3L) Diesel | | 260-413 | 1991-96 | (V8) 281 (4.6L) | | 260-457 |
| 1988-92 | (V6) 273 (4.5L) | | 260-415 | 1968-96 | (V8) 289 (4.7L), 302 (5.0L), 351W (5.8L) | | 260-451 |
| 1980-92 | (V8) 307Y (5.0L), 350N (5.7L) Diesel | | 260-413 | 1970-81 | (V8) 351 (5.8L), C,M, 400 (6.6L) | | 260-454 |
| 1964-84 | (V8) 368 (6.0L), 425,472,500 | | 260-414 | 1973-90 | (V8) 370 (6.1L), 429 (7.0L), 460 (7.5L) | | 260-455 |
| CHEVROLET | | | | HONDA | | | |
| 1976-88 | (4) 98C (1.6L) | | 260-416 | 1975-88 | (4) 1342CC,1488CC (1.5L), 1599CC (1.6L) | | 260-459 |
| 1983-91 | (4) 121 (2.0L) I,B,P | | 260-418 | OLDSMOBILE | | | |
| 1990-96 | (4) 134 (2.2L) | | 260-405 | 1983-94 | (4) 112G (1.8L), 121 (2.0L) B,P,I | | 260-418 |
| 1977-92 | (4) 151 (2.5L) | | 260-400 | 1978-93 | (4) 151 (2.5L) 1,5,9,R,V | | 260-400 |
| 1980-92 | (V6) 173 (2.8L) W,X,Z,I | | 260-407 | 1980-92 | (V6) 173 (2.8L) W,X,Z | | 260-407 |
| 1979-95 | (V6) 231 (3.8L) A,3,8,9 | | 260-410 | 1976-96 | (V6) 181 (3.0L) E,L, 231 (3.8L) A,B,C,2,3, 252 (4.1L) | | 260-410 |
| 1982-85 | (V6) 260 (4.3L) Diesel | | 260-413 | 1975-91 | (V8) 260 (4.3L) F,8, 260 (4.3L) Diesel, 307Y (5.0L), 350R (5.7L), 350N (5.7L) Diesel | | 260-413 |
| 1985-93 | (V6) 262Z (4.3L) | | 260-412 | 1977-96 | (V8) 267 (4.4L) J, 305 (5.0L), 350 G,L | | 260-425 |
| 1957-95 | (V8) 265, 267, 283, 302, (305), 307, 327, 350 to 1996 | | 260-425 | PONTIAC | | | |
| 1980-85 | (V8) 350N Diesel | | 260-413 | 1981-87 | (4) 98C (1.6L) | | 260-416 |
| CHEVY/ GMC | | | | 1982-94 | (4) 112 (1.8L) J.O, OHC, 112G, 121 (2.0L) B,K,M,P | | 260-418 |
| 1983-84 | (4) 121 (2.0L) | | 260-418 | 1977-93 | (4) 151 (2.5L) F,R,U,V,I,2,5,9 | | 260-400 |
| 1982-92 | (V6) 173 (2.8L) | | 260-407 | 1980-89 | (V6) 173 (2.8L) L,S,W,X,Z,1,7,9 | | 260-407 |
| 1985-93 | (V6) 262N,Z (4.3L) | | 260-412 | 1985-96 | (V6) 181 (3.0L) E,L, 231 (3.8L) A,B,C,2,3, 252 (4.1L) | | 260-410 |
| 1963-91 | (V6) 292 (4.8L) | | 260-415 | 1982-85 | (V6) 260 (4.3L) Diesel | | 260-413 |
| 1977-up | (V8) 305 (5.0L), 307 (5.0L), 327 (5.4L) | | 260-425 | 1977-82 | (V8) 265 (4.3L), 301 (4.9L) T,W,Y | | 260-409 |
| 1969-up | (V8) 350 (5.7L) | | 260-425 | 1977-93 | (V8) 305 (5.0L), 350L (5.7L) | | 260-425 |
| 1978-81 | (V8) 350Z (5.7L) Diesel | | 260-413 | 1977-85 | (V8) 350R (5.7L), 350N (5.7L) Diesel, 403 (6.6L) | | 260-413 |
| 1966-97 | (V8) 366 (6.0L), 427 (7.0L), 454 (7.4L) | | 260-426 | | | | |
| 1982-95 | (V8) 381 (6.2L) Diesel, 395 Diesel | | 260-421 | | | | |



papco EXPANSION PLUGS ASSORTMENTS ASSORTIMENTS DE BOUCHONS D'EXPANSION

GARAGE ASSORTMENT No. 020-048

Contains 50 Standard and
Cup Type Expansion Plugs.



Assortment is packed in rigid, transparent plastic box. See page 3 for contents.



MASTER ASSORTMENT No. 020-666

Contains 120 Metric Standard
and Cup Type Expansion
Plugs in 16 popular sizes.

MASTER ASSORTMENT No. 020-633

Contains 110 Cup and Shallow
Cup Type Expansion Plugs in
18 popular sizes.

MASTER ASSORTMENT No. 020-640

Contains 140 Standard and
Cup Type Expansion Plugs in
19 popular sizes.

These assortments are packed in metal boxes with high-strength plastic compartments. Features retail price codes on grease-resistant lid label and safety snap-lock handle. See page 7 for more details.

SUPER-SERVICE ASSORTMENT No. 020-800

Contains 200 Standard
and Cup Type Expansion
Plugs in 29 popular sizes.

SUPER-SERVICE ASSORTEMENT No. 020-801

Contains 170 Cup and
Shallow Cup Type Expan-
sion Plugs in 30 popular
sizes.



SUPER-SERVICE ASSORTMENT No. 020-840

Contains 180 Metric
Standard and Cup Type
Expansion Plugs in 28
popular sizes.

SUPER-SERVICE ASSORTMENT No. 020-841

Contains 150 Metric Cup
and Shallow Cup Type
Expansion Plugs in 25
popular sizes.

These assortments are packed in large size metal boxes with moulded plastic compartments. Features grease-resistant lid label, safety snap-lock handle and retail price codes. See page 9 for more details.

papco EXPANSION PLUGS MERCHANDISERS PRESENTOIRS DE BOUCHONS D'EXPANSION



34" w. x 11" h. x 11-5/8" d.

MERCHANDISER No. 022-098

INCH

Contains 1000 Standard,
Cup and Shallow Cup
Type Expansion Plugs. A
total of 54 popular inch
sizes. Packed in an all-
metal, 18 drawer cabinet.

MERCHANDISER No. 022-099

METRIC

Contains 600 Metric
Standard, Cup and Shal-
low Cup Type Expansion
Plugs. A complete cover-
age of all Metric Plugs.
Packed in an all-metal, 18
drawer cabinet.

For more details see page 12.

263
Series

papeco

'E-Z SEAL' EXPANSION PLUGS
BOUCHONS D'EXPANSION 'E-Z SEAL'



A new Expansion Plug designed to save Mechanic's time... will save hours of repair time in replacing core hole plugs, by simply tightening, even when Starter, Generator, Distributor, Manifold, Steering Linkage or Air Conditioner Components interfere.

Individually Carded
Handy instructions on back of each card.



- Slips in easily.
- Can be finger-tightened.
- Permanently set with open end wrench.
- No metal comes in contact with the coolant.
- Body of plug is specially compounded Neoprene, resistant to heat, antifreeze, and rust inhibitors.
- Expands as much as 1/8" to seal tightly against irregularities.

INCH
Order by Stock Number

| Stock No. | Size | Metr. Equiv. | Stock No. | Size | Metr. Equiv. | Stock No. | Size | Metr. Equiv. |
|-----------|-------|--------------|-----------|-------|--------------|-----------|-------|--------------|
| 263-548 | 3/4 | 19mm | 263-588 | 1-3/8 | 35mm | 263-620 | 1-7/8 | 48mm |
| 263-556 | 7/8 | 22mm | 263-596 | 1-1/2 | 38mm | 263-628 | 2" | 51mm |
| 263-564 | 1" | 25mm | 263-604 | 1-5/8 | 41mm | 263-636 | 2-1/8 | 54mm |
| 263-572 | 1-1/8 | 29mm | 263-612 | 1-3/4 | 45mm | 263-644 | 2-1/4 | 57mm |
| 263-580 | 1-1/4 | 32mm | | | | | | |

METRIC

Install dry.
Do not use sealer.
Do not use where petroleum products contact rubber.
Do not overtighten.

Installe a sec.
L'employer pas d'adhésive.
L'employer pas ou des produits pétroleux d'evientront en contact avec le néoprène.
Ne pas trois serre.

Make sure washer and nut are loose.
Faire certain que la rondelle et l'ecrou ne sont pas serré.

Washer must be flush with side of wall before and after plug is installed.
La rondelle doit être égale avec le coté du mur avant d'être installé.

①



Plug must extend 1/4" beyond inside wall to allow a ridge to form.
Le tampons doit dépassé le mur intérieure d'au moins 1/4 de pouce pour permettre la formation d'un coussin.

Turn the nut clockwise 2 or 3 turns to form a ridge and properly set plug.
Pour bien placé ce tampon, serré l'ecrou de 2 ou 3 tours.

When properly installed plug will hold pressure to 50 P.S.I.
Quand bien posée un tampon soutiendra une pressions de 50 P.S.I.

②



papeco 'E-Z SEAL' EXPANSION PLUG
MERCHANDISER No. 022-123

Includes Rack, Header Sign, Inventory Control, Planogram and a 20 card stock of 'E-Z Seal Plugs' listed above.



ASSORTMENT No. 020-318

Contains 13 'E-Z Seal' Expansion Plugs - one of each size. Have every size on hand - repair leaking metal frost plugs in all locations - whether hard or easy to get to.



020-318

Contient 13 bouchons d'expansion 'E-Z Seal' - un de chaque format. Ayez tous les formats en main. Réparez les bouchons en métal protégeant contre la gelée à tous les endroits - difficiles ou faciles à rejoindre.

Use 'E-Z Seal' for Inch and Metric applications



267
Series

papco

**THICKNESS GAUGE LENGTHS
CALIBRES D'ÉPAISSEUR**



"Papco" Thickness Gauges are made from No. 1 Grade Swedish Steel, uniformly tempered and are of the highest accuracy obtainable. Each gauge is 12" long by 1/2" wide and has a hole punched in the end for hanging. The thickness in thousandths is permanently etched on the gauge. Standard package contains six lengths of a size, and each gauge is individually cellophane wrapped.

Order by Stock Number

Standard Package 6 Lengths

| Stock No. | Thickness | Stock No. | Thickness | Stock No. | Thickness |
|-----------|-----------|-----------|-----------|-----------|-----------|
| 267-015 | .0015 | 267-110 | .010 | 267-120 | .020 |
| 267-020 | .002 | 267-111 | .011 | 267-122 | .022 |
| 267-025 | .0025 | 267-112 | .012 | 267-124 | .024 |
| 267-030 | .003 | 267-113 | .013 | 267-125 | .025 |
| 267-040 | .004 | 267-114 | .014 | 267-126 | .026 |
| 267-050 | .005 | 267-115 | .015 | 267-128 | .028 |
| 267-060 | .006 | 267-116 | .016 | 267-130 | .030 |
| 267-070 | .007 | 267-117 | .017 | 267-132 | .032 |
| 267-080 | .008 | 267-118 | .018 | 267-140 | .040 |
| 267-090 | .009 | 267-119 | .019 | | |

papco



**PRECISION CALIPER
COMPAS PRECISION**

No. 022-031

"Papco" Precision Caliper is made of high impact styrene. Useful for all types of measurements in both inch and metric. Measures inside diameter, outside diameter, length and depth. Scales in 1/16" or 1mm increments.

Individually skin-packed.

Order by Stock No. 022-031

papco

**BOLT and NUT GAUGE
CALIBRE POUR BOULONS
et ECROUS**

No. 022-030

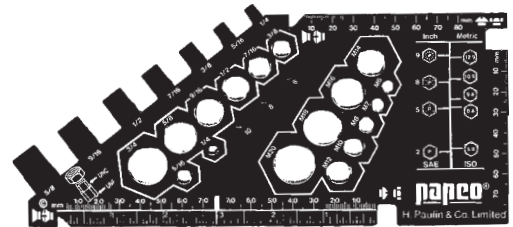

Heavy duty, plastic gauge for measuring UNC, UNF and Metric bolts, nuts, screws and studs. Individually packaged.

Order by Stock No. 022-030

papco

**ANTI-FREEZE TESTER
VERIFICATEUR D'ANTIGEL**

No. 263-999

- Tests all ETHYLENE GLYCOL solutions
- Allows visual inspection for rust and sediment
- Shows both degrees Fahrenheit and Celsius
- Individually blister-packed

Order by Stock No. 263-999

Winter Protection

Accurately and quickly indicates the freezing point of radiator solution.

Summer Protection

Indicates boiling point of coolant.

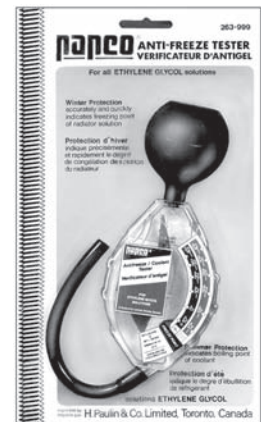



AIR CLEANER WING NUTS ECROUS A OREILLES POUR FILTRE A AIR



Universal type replacements for lost or stripped Air Cleaner Wing Nuts. Self-threaded series nylon nuts cut their own thread and may be used on either inch or metric hold-down shafts.

262
Series



262-314
262-316



262-324
262-325



262-326



700-106
700-108

Order by Stock Number

| Stock No. | Size | Description | Qty. | Stock No. | Size | Description | Qty. |
|-----------|------------|----------------------|------|-----------|---------|-----------------|------|
| 262-314 | 1/4 & 6mm | Self Threading Nylon | 10 | 262-326 | 1/4-20 | Chrysler Nylon | 5 |
| 262-316 | 5/16 & 8mm | Self Threading Nylon | 10 | 700-106 | M6x1.0 | Metric Wing Nut | 25 |
| 262-324 | 1/4-20 | Universal Domestic | 10 | 700-108 | M8x1.25 | Metric Wing Nut | 25 |
| 262-325 | M6x1.0 | Universal Imports | 10 | | | | |

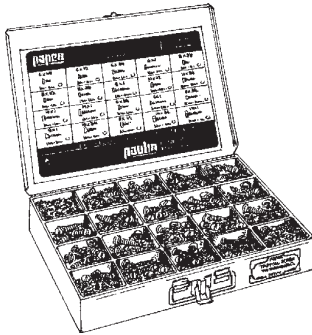

WING NUT AND HOOD PROP CLIP MASTER ASSORTMENT No. 020-608

Contains 90 pieces - 16 sizes of all listed Air Cleaner Wing Nuts as above - plus 5 sizes of Hood Prop Clips (see page 103).
Packed in a rigid all metal lidded box.



PCV VALVE GROMMETS RONDELLES ISOLANTES EN CAOUTCHOUC PCV

263
Series



PCV Valve Grommets are exposed to high temperatures and oil contamination that cause deterioration and eventual failure. Malfunction of these grommets can result in poor performance and reduced gas mileage. Grommets should be replaced at tune-up intervals.



Order by Stock Number

| Stock No. | Description | Std. Pkg. | Stock No. | Description | Std. Pkg. |
|-----------|----------------------------|-----------|-----------|-----------------------------|-----------|
| 263-201 | Universal 1/2 ID | 5 | 263-211 | Ford 1985-1986 | 5 |
| 263-202 | Universal 5/8 ID | 5 | 263-212 | GM 1961-1990 | 5 |
| 263-203 | GM 1979-1990 | 5 | 263-213 | AMC (4/6) 1983-1988 (Rear) | 5 |
| 263-204 | Chrysler 1965-1990 | 5 | 263-214 | AMC (4/6) 1983-1990 (Front) | 5 |
| 263-205 | GM (V-6) 3.8/4.1 1988-1986 | 5 | 263-215 | GM 1976-1983 | 5 |
| 263-206 | GM (V-6) 2.8L 1980-1986 | 5 | 263-216 | Ford (4/6/8) 1987-1990 | 5 |
| 263-207 | AMC 1965-1990 | 5 | 263-217 | Ford (V-6) 3.0L 1986 | 3 |
| 263-208 | GM (V-6) 3.8L 1975-1990 | 5 | 263-218 | Pontiac (V-8) 1964-1975 | 3 |
| 263-209 | Toyota 1970-1984 | 5 | 263-225 | Elbow Ford 1968-1990 | 3 |
| 263-210 | Toyota 1984-1990 | 5 | 263-226 | Elbow GM (V-8) 1968-1990 | 3 |

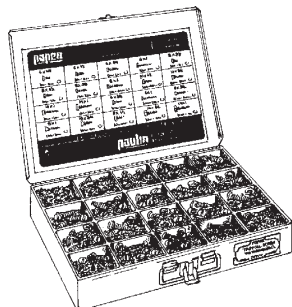

PCV VALVE GROMMET MASTER ASSORTMENT No. 020-683

Contains 42 Grommets - 20 sizes as listed above.
Packed in a metal divided box with hinged lid.



papco

**THROTTLE ROD CLIPS and RETAINERS
ATTACHES DE TIGE A SOUPAPE**

"Papco" Throttle Rod Clips are made of hardened spring steel in right and left hand styles. The retainer springs, or hairpin cotters, are measured by the diameter of the centre eye.

**262
Series**



TYPE 1



TYPE 2



TYPE 3



TYPE 4



TYPE 5

Order by Stock Number

| Stock No. | Size | Type | Std. Pkg. | Stock No. | R. Dia. | Type | Std. Pkg. | Stock No. | Size | Type | Std. Pkg. |
|-----------|-------|------|-----------|-----------|---------|------|-----------|-----------|------|------|-----------|
| 262-008* | 5/32R | 1 | 25 | 262-056* | 1/8 | 2 | 25 | 262-078* | 5/32 | 3 | 100 |
| 262-009* | 5/32L | 1 | 25 | 262-060* | 1/4 | 2 | 25 | 262-080 | 3/16 | 3 | 100 |
| 262-010* | 3/16R | 1 | 25 | 262-062* | 1/8(GM) | 4 | 25 | 262-084 | 1/4 | 3 | 100 |
| 262-011* | 3/16L | 1 | 25 | 262-064* | 1/4(GM) | 4 | 25 | 262-086 | 5/16 | 3 | 100 |
| 262-014* | 1/4R | 1 | 25 | 262-073* | 1/16 | 3 | 100 | 262-088 | 3/8 | 3 | 100 |
| 262-015* | 1/4L | 1 | 25 | 262-075* | 5/64 | 3 | 100 | 268-516 | 5/16 | 5 | 18 |
| 262-054* | 3/32 | 2 | 25 | 262-076* | 1/8 | 3 | 100 | | | | |

*Retainers

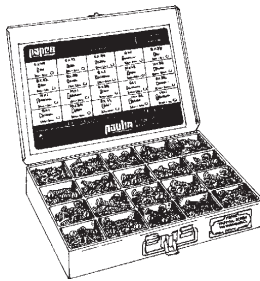

**CARBURETOR CLIP
MASTER
ASSORTMENT
NO. 020-609**

Contains 293 pieces, 18 sizes for complete coverage. Packed in an all metal, lidded box. See page 6 for contents listing.



**THROTTLE ROD CLIP
GARAGE ASSORTMENT
NO. 020-022**

Contains 104 pieces, *15 sizes as listed above, includes both clips and hairpin cotters. Packed in a transparent plastic box with individual sections. Useful for carburetor repair jobs.

**262
Series**

papco

**THROTTLE BALL JOINTS
JOINTS A ROTULE**

Used to adjust throttle linkages and control rods on automobiles, trucks, snowmobiles, marine and off the road equipment. Made of heat treated carbon steel and bright plated for corrosion resistance.

Type G
(Solid)

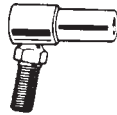

High strength design with good wear resistance for heavy duty service. Oil and gas resistant rubber shield protects against abrasive dirt.

Type A
(Spring
Loaded)

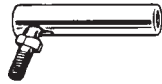

Conforms to S.A.E. Standards with case hardened seats and ball studs for extra wear resistance. Spring loaded for zero end-play.

Type P
(Quick
Disconnect)



Lightweight economical quick disconnect design. Ball studs can be removed from spring steel retaining clip for making length adjustments.

Convenient skin-packed card contains one Ball Joint.

Individually Carded

Order by Card Number

| Card No. | Type | Size | Card No. | Type | Size |
|----------|------|---------|----------|------|---------|
| 262-203 | G | 10-32 | 262-208 | G | 1/2-20 |
| 262-204 | G | 1/4-28 | 262-210 | A | 10-32 |
| 262-205 | G | 5/16-24 | 262-211* | A | 1/4-28 |
| 262-206* | G | 3/8-24 | 262-212* | A | 5/16-24 |
| 262-207 | G | 7/16-20 | 262-218 | P | 1/4-28 |

* Most Popular



268
Series

papeco SNAP RINGS CIRCLIPS

HIGH CARBON STEEL

RETAINER RINGS

HEAT TREATED FOR RESILIENCY

Used as retainers on automotive, appliance and heavy equipment applications. Packaged in uniformly priced transparent packs. Number of rings per pack is shown below.

Order by Stock Number

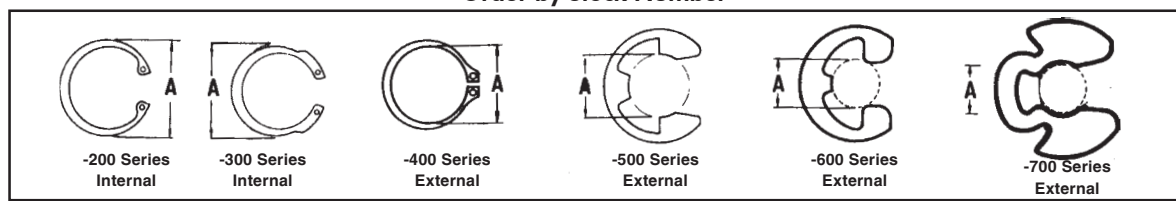

INTERNAL TYPES (HOUSING)

EXTERNAL TYPES (SHAFT)

| Stock No. | Industry No. | Housing Dia. | Free Dia. "A" | Pieces Per Pack | Stock No. | Industry No. | Shaft Dia. | Free Dia. "A" | Pieces Per Pack |
|-------------------------------|--------------|--------------|---------------|-----------------|-----------|--------------|------------|---------------|-----------------|
| 268-222 | 5000-50 | 1/2" | .548" | 10 | 268-436 | 5100-131 | 1-5/16" | 1.214" | 4 |
| 268-224 | 5000-62 | 5/8 | .694 | 10 | 268-438 | 5100-137 | 1-3/8 | 1.272 | 4 |
| 268-226 | 5000-75 | 3/4 | .831 | 8 | 268-440 | 5100-150 | 1-1/2 | 1.387 | 3 |
| 268-227 | 5000-81 | 13/16 | .901 | 8 | 268-442 | 5100-175 | 1-3/4 | 1.618 | 2 |
| 268-228 | 5000-87 | 7/8 | .971 | 6 | 268-444 | 5100-200 | 2" | 1.850 | 2 |
| 268-230 | 5000-100 | 1" | 1.111 | 6 | 268-505 | 5133-12 | 1/8 | .094 | 18 |
| 268-231 | 5000-106 | 1-1/16 | 1.180 | 5 | 268-506 | 5133-15 | 5/32 | .114 | 18 |
| 268-232 | 5000-112 | 1-1/8 | 1.249 | 5 | 268-510 | X5133-18 | 3/16 | .122 | 18 |
| 268-234 | 5000-125 | 1-1/4 | 1.388 | 4 | 268-511 | 5133-18 | 3/16 | .145 | 18 |
| 268-237 | 5000-137 | 1-3/8 | 1.526 | 4 | 268-514 | 5133-25 | 1/4 | .207 | 18 |
| 268-238 | 5000-150 | 1-1/2 | 1.660 | 3 | 268-516 | 5133-31 | 5/16 | .243 | 18 |
| 268-242 | 5000-175 | 1-3/4 | 1.942 | 2 | 268-518 | 5133-37 | 3/8 | .300 | 14 |
| 268-246 | 5000-200 | 2" | 2.210 | 2 | 268-520 | 5133-43 | 7/16 | .337 | 14 |
| 268-329 | 5008-093 | 15/16 | 1.015 | 6 | 268-522 | 5133-50 | 1/2 | .392 | 12 |
| 268-330 | 5008-100 | 1" | 1.081 | 6 | 268-606 | 5144-15 | 5/32 | .113 | 18 |
| 268-332 | 5008-112 | 1-1/8 | 1.217 | 5 | 268-610 | 5144-18 | 3/16 | .143 | 18 |
| EXTERNAL TYPES (SHAFT) | | | | | 268-614 | 5144-25 | 1/4 | .204 | 18 |
| 268-414 | 5100-25 | 1/4 | .225 | 15 | 268-616 | 5144-31 | 5/16 | .242 | 18 |
| 268-418 | 5100-37 | 3/8 | .338 | 14 | 268-618 | 5144-37 | 3/8 | .292 | 14 |
| 268-422 | 5100-50 | 1/2 | .461 | 10 | 268-620 | 5144-56 | 9/16 | .430 | 9 |
| 268-424 | 5100-62 | 5/8 | .579 | 10 | 268-714 | T5304-25 | 1/4 | .187 | 7 |
| 268-426 | 5100-75 | 3/4 | .693 | 8 | 268-716 | T5304-31 | 5/16 | .250 | 6 |
| 268-428 | 5100-87 | 7/8 | .810 | 7 | 268-718 | T5304-37 | 3/8 | .312 | 6 |
| 268-430 | 5100-100 | 1" | .925 | 6 | 268-722 | T5304-50 | 1/2 | .406 | 5 |
| 268-432 | 5100-112 | 1-1/8 | 1.041 | 5 | 268-724 | T5304-62 | 5/8 | .500 | 4 |
| 268-434 | 5100-125 | 1-1/4 | 1.156 | 4 | | | | | |

SNAP RING GARAGE ASSORTMENT No. 020-040



Contains 60 Snap Rings, 9 sizes of 268-500 Series, for 1/8 to 1/2" dia. shafts.

SNAP RING MASTER ASSORTMENT No. 020-627

Contains 401 Snap Rings, 36 sizes. Priced label in lid has actual size ring outlines for easy identification. Metal box has moulded compartments. Has a complete stock of all ring sizes and types listed above.

Size: 9-3/4" w. x 13-3/4" l. x 2" d.

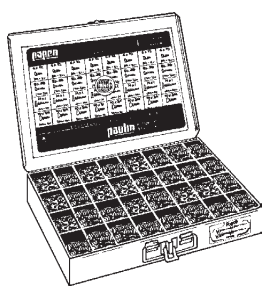

papeco SUPER SERVICE ASSORTMENT No. 020-817

Contains 705 Snap Rings - 50 sizes.
Large size, rigid metal box with high-strength plastic compartments.
For more details see page 9. Large size: 12" w. x 18" l. x 3" d.



268
Series

papeo

SNAP RINGS CIRCLIPS
AGRAFES DE BUTÉE

Packaged in uniformly priced transparent packs.

Order by Stock Number

Illustrations Actual Size

* Example of Stock Number: 268-246

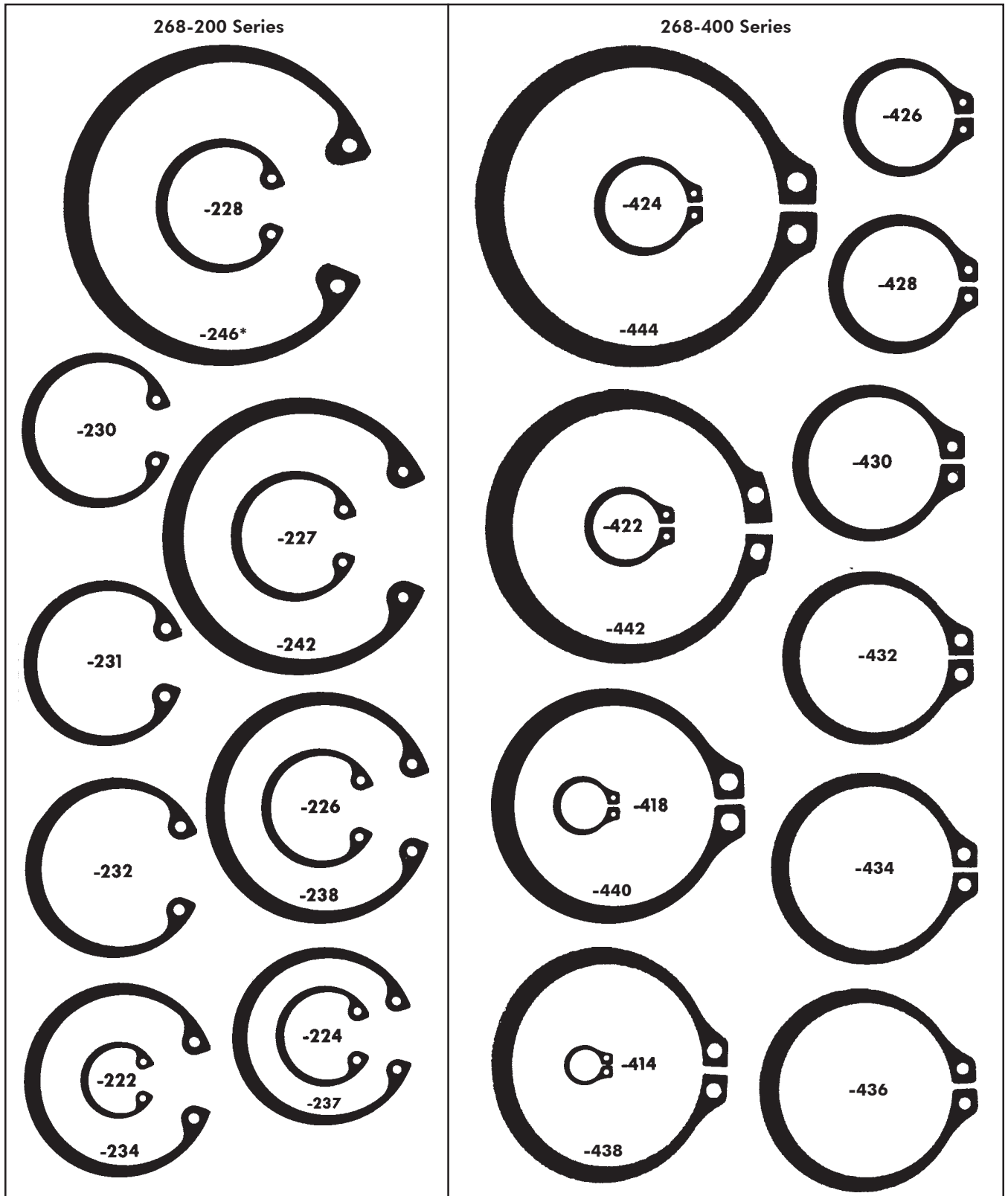

For Other sizes of Snap Rings - see next page.



268
Series

papeco

**SNAP RINGS
CIRCLIPS**

* Example of Stock
Number: 268-522

Order by Stock Number

Illustrations Actual Size

| | |
|-------------|-----------------------|
| <p>-329</p> | <p>268-500 Series</p> |
| <p>-330</p> | <p>268-600 Series</p> |
| <p>-332</p> | <p>268-700 Series</p> |

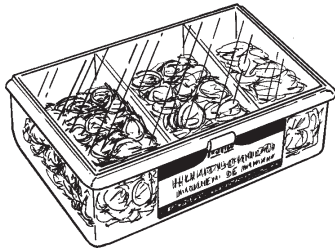

**SNAP RING
GARAGE ASSORTMENT No. 020-041**

Contains 50 External Snap Rings, 6 sizes of 268-600 Series for 5/32" through 9/16" dia. shafts.

GARAGE ASSORTMENT No. 020-042

Contains 50 Internal Snap Rings, 10 sizes of 268-200 Series for 1/2" through 2" housing diameters.

262
Series

papeco

**SNAP RING PLIERS
PINCES A CIRCLIP**

Order by Stock Number

Individually Carded

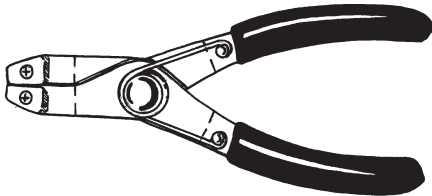

No. 262-980 EXTERNAL with TIPS (Black)
No. 262-981 INTERNAL with TIPS (Red)
No. 262-982 SNAP RINGS PLIERS SET
 Economical tools for medium duty.
 Non-slip cushion coated grips on stamped steel handles.
 Complete with four sets of tips.

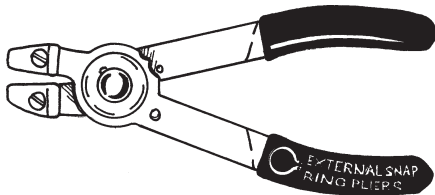

No. 262-976 EXTERNAL with TIPS (Black)
No. 262-977 INTERNAL with TIPS (Red)
 Professional quality tools have no exposed springs to pop out or snag other tools. Non-slip cushion-coated handles make pliers easy to grip and use.
 Complete with four sets of tips.



No. 262-983 PRECISION TIPS SET

| | |
|----------------------|-----------------|
| 1 pr. .045" Straight | 1 pr. .035" 45° |
| 1 pr. .060" Straight | 1 pr. .045" 90° |



263
Series



papco® 'DUO-DRAIN' OIL PLUG
BOUCHON D'HUILE DUO-DRAIN®

BRIGHT PLATED

All metal, two-part plug for repairing 1/2"-20 crankcase applications on GM, Ford, Chrysler and AMC. STANDARD or Self-tapping DOUBLE OVERSIZE outer plug installs permanently. Only the pipe threaded centre plug is removed to drain oil. Convenient skin-packed card contains one (1) Duo-Drain Oil Plug complete with gasket.

1/2 Standard No. 263-798 1/2-20 D.O. No. 263-799



papco® **CARDED**
DRAIN PLUGS with GASKET
BOUCHON DE VIDANGE avec JOINT

Convenient skin-packed card contains one 'Papco' Drain Plug complete with nylon gasket. Order by Card Number.

| Card No. | Size & Thread | Gasket No. | Card No. | Size & Thread | Gasket No. |
|----------|------------------|------------|----------|----------------------|------------|
| 263-780 | 12mm x 1.75 Std. | 263-815 | 263-789 | 20mm x 1.5 Std. | 263-824 |
| 263-782 | 12mm x 1.25 Std. | 263-815 | 263-790 | 1/2-20 Std. | 263-816 |
| 263-783 | 14mm x 1.5 Std. | 263-817 | 263-791 | 1/2-20 O.S. Self-Tap | 263-816 |
| 263-785 | 16mm x 1.33 Std. | 263-820 | 263-792 | 1/2-20 D.O. Self-Tap | 263-817 |
| 263-787 | 12mm x 1.75 Std. | 263-824 | 263-793 | 1/2-20 T.O. Self-Tap | 263-820 |



Card No.
263-791

'Papco' CARDED OIL DRAIN PLUG MERCHANDISER No. 022-130

Contains all 15 sizes of carded 'Papco' Oil Drain Plugs with gaskets, plus 4 sizes of 'Papco' E-Z Seal Oil Drain Plugs - 26 plugs in total. Includes header sign and merchandising rack suitable for wall, pegboard, counter or gondola display. See page 130 for carded Magnetic Drain Plugs.

papco® **DRAIN PLUG GASKETS**
JOINTS POUR BOUCHON DE VIDANGE

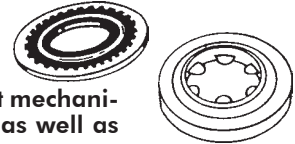

'Papco' Selon® Drain Plug Gaskets are made of special nylon with excellent mechanical properties and long life. Also available are copper and fibre gaskets as well as aluminum and rubber/metal gaskets.

Order by Stock Number

Standard Package 25 Pieces

| Part No. | Description | Part No. | Description | Part No. | Description |
|----------|----------------------|----------|---------------------------|----------|---------------------------|
| 263-815 | Nylon 31/64 x 3/4 | 263-856 | Copper 19/32 x 13/16 | 263-805 | Fibre 13/16 x 1 x 3/32 |
| 263-816 | Nylon 9/16 x 13/16 | 263-857 | Copper 5/8 x 1" | 263-807 | Fibre .920 x 1-1/8 x 3/32 |
| 263-817 | Nylon 5/8 x 15/16 | 263-860 | Copper 3/4 x 1-1/16 | 263-808 | Fibre 12mm x .748 x 3/32 |
| 263-818 | Nylon 12mm x 25mm | 263-800 | Fibre 1/2 x 3/4 x 3/32 | 263-809 | Fibre 16mm x 1.062 x 3/32 |
| 263-820 | Nylon 11/16 x 1" | 263-801 | Fibre 9/16 x 13/16 x 3/32 | 263-810 | Fibre 18mm x 1.062 x 3/32 |
| 263-824 | Nylon 13/16 x 1-1/16 | 263-802 | Fibre 5/8 x 7/8 x 3/32 | 263-870 | Alum. 14mm x 20mm |
| 263-828 | Nylon 31/64 x 1-1/4 | 263-803 | Fibre 11/16 x 7/8 x 3/32 | 263-873 | Alum. 18mm x 26mm |
| 263-855 | Copper 31/64 x 3/4 | 263-804 | Fibre 3/4 x 1-1/16 x 3/32 | 263-875 | Rubber/Met. 12mm x 25mm |

GARAGE ASSORTMENT No. 020-054

Contains 60 Nylon Gaskets in six popular sizes for Inch and Metric Drain Plugs.

GARAGE ASSORTMENT No. 020-038

Contains 9 Inch and Metric Drain Plugs with gaskets. (4) 1/2-20 Std. (3) 12mm x 1.75, (2) 14mm x 1.5.



GARAGE ASSORTMENT No. 020-032

Contains 7 Self-Tapping Oversize Drain Plugs with gaskets. (4) 1/2-20 O.S., (2) 1/2-20 D.O., (1) 1/2-20 T.O.

MASTER DRAIN PLUG ASSORTMENT No. 020-635

Contains 40 Inch and Metric Plugs; 85 Gaskets - and includes Magnetic and 1/2-20 oversize plugs. 16 Sizes of Plugs, 10 Sizes of Gaskets. Complete coverage for most vehicles.

MASTER DRAIN PLUG GASKET ASSORTMENT No. 020-607

Contains 210 pieces - 20 of the most popular Sizes of Nylon, Copper, Fibre, Aluminum and Rubber/Metal Drain Plug Gaskets.



020-635



'Papco' Drain Plugs are manufactured in seven types and are available in Inch and Metric sizes. Type 2 oversize plugs are tapered, hardened and cut their own thread where the original has been stripped. To use an oversize plug, hold in a straight position and tighten with a socket wrench. Plug is then removed to clear metal particles and then reinstalled. Each Drain Plug is supplied with a nylon gasket.

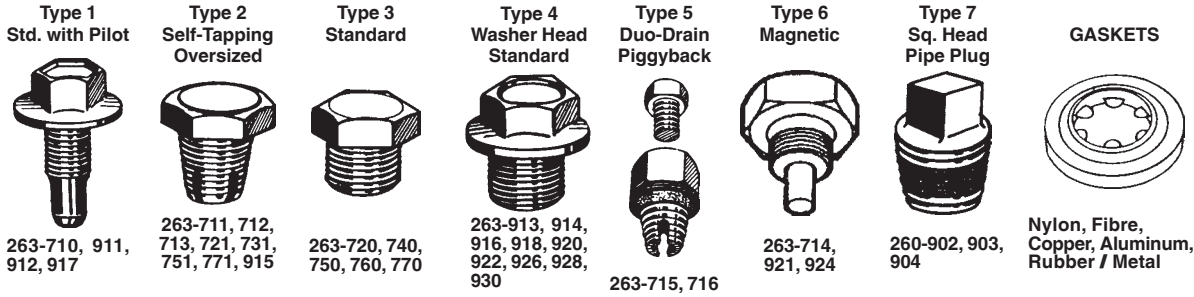

| DRAIN PLUGS | | | | GASKETS | | | | |
|-------------|----------------------------|------|-----------|--|---------|---------|----------|------------|
| Stock No. | Size & Thread | Type | Std. Pkg. | NYLON | FIBRE | COPPER | ALUMINUM | RUBB./MET. |
| 263-710 | 1/2-20 Std. | 1 | 12 | 263-816 | 263-800 | 263-856 | | 263-875 |
| 263-711 | 1/2-20 O.S. Self-Tap | 2 | 12 | 263-816 | 263-801 | 263-856 | | 263-875 |
| 263-712 | 1/2-20 D.O. Self-Tap | 2 | 12 | 263-817 | 263-801 | 263-857 | 263-870 | |
| 263-713 | 1/2-20 T.O. Self-Tap | 2 | 12 | 263-820 | 263-802 | 263-860 | | |
| 263-714 | 1/2-20 Magnetic | 6 | 12 | 263-816 | 263-800 | 263-856 | | 263-875 |
| 263-715 | 1/2-20 D.O. Duo-Drain | 5 | 5 | 263-817 | 263-801 | 263-857 | 263-870 | |
| 263-716 | 1/2-20 Std. Duo-Drain | 5 | 5 | 263-816 | 263-800 | 263-856 | | 263-875 |
| 263-720 | 5/8-18 Std. | 3 | 12 | 263-820 | | 263-860 | | |
| 263-721 | 5/8-18 O.S. Self-Tap | 2 | 12 | 263-820 | 263-803 | 263-860 | | |
| 263-731 | 1 1/16-16 O.S. Self-Tap | 2 | 12 | 263-824 | 263-804 | | | |
| 263-750 | 3/4-16 Std. | 3 | 12 | 260-824 | | | | |
| 263-751 | 3/4-16 O.S. Self-Tap | 2 | 12 | 263-824 | 263-805 | | | |
| 263-760 | 7/8-16 Std. | 3 | 12 | 263-828 | | | | |
| 263-770 | 7/8-18 Std. | 3 | 12 | 263-828 | | | | |
| 263-771 | 7/8-18 O.S. Self-Tap | 2 | 12 | 263-828 | 263-807 | | | |
| 263-911 | M12 x 1.75 Std. with Pilot | 1 | 12 | 263-815 | 263-808 | 263-855 | | 263-875 |
| 263-912 | M12 x 1.25 Std. with Pilot | 1 | 12 | 263-815 | 263-808 | 263-855 | | 263-875 |
| 263-913* | M12 x 1.25 Std. | 4 | 12 | 263-815 | 263-808 | 263-855 | | 263-875 |
| 263-914 | M14 x 1.5 Std. | 4 | 12 | 263-817 | 263-801 | 263-856 | 263-870 | |
| 263-915 | M14 x 1.5 O.S. Self-Tap | 2 | 12 | 263-820 | | 263-860 | | |
| 263-916* | M16 x 1.33 | 4 | 12 | 263-820 | | 263-860 | | |
| 263-917 | M14 x 1.5 Std. with Pilot | 1 | 12 | 263-817 | 263-801 | 263-856 | 263-870 | |
| 263-918 | M18 x 1.5 Std. | 4 | 12 | 263-824 | | 263-860 | 263-873 | |
| 263-920 | M20 x 1.5 Std. | 4 | 12 | 263-824 | | | | |
| 263-921 | M12 x 1.75 Magnetic | 6 | 5 | 263-815 | 263-808 | 263-855 | | 263-875 |
| 263-922 | M14 x 1.25 Std. | 4 | 12 | 263-817 | 263-801 | 263-856 | 263-870 | |
| 263-924 | M14 x 1.5 Magnetic | 6 | 12 | 263-817 | 263-801 | 263-856 | 263-870 | |
| 263-926 | M16 x 1.33 w/Fibre Gask. | 4 | 5 | 263-820 | 263-809 | | | |
| 263-928 | M18 x 1.5 w/Std. Fibre Gs. | 4 | 5 | 263-824 | 263-810 | | 263-873 | |
| 263-930 | M20 x 1.5 w/Std. Fibre Gs. | 4 | 5 | 263-824 | | | | |
| 260-902 | 1/4" Sq. Pipe Plug | 7 | 12 | ALL GASKETS STANDARD PACKAGE 25 PIECES | | | | |
| 260-903 | 3/8" Sq. Pipe Plug | 7 | 12 | | | | | |
| 260-904 | 1/2" Sq. Pipe Plug | 7 | 12 | | | | | |
| | | | | | | | | |

* Nominal Diameter

CARDER MAGNETIC DRAIN PLUG with GASKET

'Papco' Magnetic Drain Plugs reduce wear and protect engines by attracting harmful metal particles circulating in the crankcase oil. Powerful, long-lasting ALNICO magnet. Install in place of ordinary plugs. Individually skin-packed with gasket.

| Card No. | Size & Thread | Gasket No. | Card No. | Size & Thread | Gasket No. |
|----------|----------------------|------------|----------|----------------------|------------|
| 263-781 | 12mm x 1.75 Magnetic | 263-815 | 263-794 | 1/2-20 Std. Magnetic | 263-816 |
| 263-784 | 14mm x 1.5 Magnetic | 263-817 | | | |





263
Series

papeco

DRAIN PLUG APPLICATION CHART APPLICATION DE BOUCHON DE VIDANGE

| Year | Cyl. | Application | Plug Part No. | Carded Part No. | E-Z Seal Part No. | Year | Cyl. | Application | Plug Part No. | Carded Part No. | E-Z Seal Part No. |
|-----------------|------|---|---------------|-----------------|-------------------|-----------------------|--------------------------------|---|---------------|-----------------|-------------------|
| ACURA | | | | | | GM/ GMC | | | | | |
| 1986-up | All | | 263-914 | 263-783 | 263-322 | 1982-up | (8) | 260, 262, 265, 267, 4.4 Chev, 302, 305, 307, 327, 330, 340, 348, 350 All, 366, 368, 396, 400, 402, 403, 409, 425, 427, 429, 430, 454, 455, 472, 500 | *263-710 | 263-790 | †263-320 |
| AMC | | | | | | HONDA | | | | | |
| 1983-up | (4) | AMC/ Renault Engine | 263-922 | — | — | 1987-91 | All Inc. | 83-86 Prelude | 263-914 | 263-783 | 263-322 |
| 1980-83 | (4) | 2.5(151) GM Engine | 263-911 | 263-780 | 263-290 | 1973-86 | All Exc. | Prelude | 263-920 | 263-789 | — |
| 1976-80 | (4) | 121 CID | 263-914 | 263-783 | 263-322 | HYUNDAI | | | | | |
| 1964-85 | (6) | (8) All Inline 6 and V8 | *263-710 | 263-790 | †263-320 | 1986-91 | All | | 263-914 | 263-783 | 263-322 |
| AUDI | | | | | | ISUZU | | | | | |
| 1974-91 | All | | 263-914 | 263-783 | 263-322 | 1981-89 | | | 263-914 | 263-783 | 263-322 |
| CHRYSLER | | | | | | 1987-90 | (4) | All | 263-922 | — | — |
| 1987-up | (4) | 2.2(135), 2.5(153) | 263-913 | 263-782 | 263-290 | LEXUS | | | | | |
| 1981-87 | (4) | 2.2(135), 2.5(153), 1.7, 2.6 | 263-914 | 263-783 | 263-322 | 1990-91 | All | | 263-922 | — | — |
| 1990-up | (6) | 3.3(201.5) | 263-913 | 263-782 | 263-290 | MAZDA | | | | | |
| 1960-82 | (6) | 170, 196, 225 | *263-710 | 263-790 | †263-320 | 1972-91 | All | | 263-914 | 263-783 | 263-322 |
| 1987-90 | (6) | 3.0(183) | 263-750 | — | — | MITSUBISHI | | | | | |
| 1988-91 | (6) | 5.9 Diesel | 263-918 | 263-787 | — | 1983-90 | All | | 263-914 | 263-783 | 263-322 |
| 1962-87 | (8) | All | *263-710 | 263-790 | †263-320 | NISSAN/ DATSUN | | | | | |
| 1987-91 | (8) | 5.2(318) | 263-913 | 263-782 | 263-290 | 1982-91 | All | 12mm plugs | 263-913 | 263-782 | 263-290 |
| FORD | | | | | | 1962-91 | All | 16.4mm plugs | 263-916 | 263-785 | 263-400 |
| 1970-up | (4) | All | 263-914 | 263-783 | 263-322 | PEUGOT | | | | | |
| 1973-up | (6) | 2.8(171), 2.9(177), 3.0(183) exc. 86-89, 3.8(230) exc. 82-88 | 263-914 | 263-783 | 263-322 | 1980-90 | All | 16mm plugs | 263-916 | 263-785 | 263-400 |
| 1982-89 | (6) | 3.0(183), 3.8(230) | *263-710 | 263-790 | †263-320 | 1980-86 | All | 20mm plugs | 263-920 | 263-789 | — |
| 1965-88 | (6) | 144, 170, 200, 240, 250, 300, 3.3, 4.1 | *263-710 | 263-790 | †263-320 | RENAULT | | | | | |
| 1980-up | (6) | 4.9(300) | *263-710 | 263-790 | †263-320 | 1983-87 | AMC/ Renault Engine | | 263-914 | 263-783 | 263-322 |
| 1983-91 | (8) | 4.6, 5.8(351W), 6.1(370), 6.9(420) Diesel, 7.0(429), 7.3(455), 7.5(460) | 263-914 | 263-783 | 263-322 | 1980-87 | Alliance, Encore, Fuego, LeCar | | 263-916 | 263-785 | 263-400 |
| 1957-91 | (8) | All Other 8 cyl. | *263-710 | 263-790 | †263-320 | SAAB | | | | | |
| GEO | | | | | | 1978-90 | All | | 263-914 | 263-783 | 263-322 |
| 1989-91 | | Metro, Tracker, Storm | 263-914 | 263-783 | 263-322 | SUBARU | | | | | |
| 1989-91 | | Prizm | 263-922 | — | — | 1974-90 | All | | 263-920 | 263-789 | — |
| GM/ GMC | | | | | | SUZUKI | | | | | |
| 1982-up | (4) | 1.8(112), 1.9(119), 2.0(121) | 263-914* | 263-783 | 263-322 | 1986-91 | All | | 263-914 | 263-783 | 263-322 |
| 1987-up | (4) | 1.8(112), 2.0(121), 2.2(134), 2.3(138), 2.5(151) 78-94 Buick, Chev, 78-88 Olds, Pont. | 263-911* | 263-780 | 263-290 | TOYOTA | | | | | |
| 1987-up | (4) | 2.5(151) | | | | 1980-91 | All | 12mm plugs | 263-913 | 263-782 | 263-290 |
| 1982-88 | (4) | 1.4, 1.6, 1.8(112), 2.0(121) | *263-710* | 263-790 | †263-320 | 1975-85 | All | 18mm plugs | 263-918 | 263-787 | — |
| 1982-up | (6) | 2.8(173), 3.0(181), 3.1(189) Buick, 3.4(207), 4.3T, V(260) Diesel | 263-911* | 263-780 | 263-290 | VOLKSWAGEN | | | | | |
| 1982-up | (6) | 3.3(204) Buick, 3.8(231) | *263-710 | 263-790 | †263-320 | 1974-83 | 1500cc, 1600cc | | 263-914 | 263-783 | 263-322 |
| 1980-88 | (6) | 2.8(173), 3.0(181), 3.8 (196, 200, 229), 3.8(231), 4.1(252), 4.32 Chev V6 | *263-710* | 263-790 | †263-320 | VOLVO | | | | | |
| | | | | | | 1971-89 | (4) | All Exc. Diesel | 263-750 | — | — |
| | | | | | | 1980-89 | (4) | Diesel | 263-914 | 263-783 | 263-322 |
| | | | | | | 1971-89 | (6) | All | 263-916 | 263-785 | — |

* Single, Double or Triple oversize 1/2-20 drain plugs may be required for stripped Inch Threads and in some applications, Metric Threads, see oversized plug listing on page 130.

† Use 263-320 for Oversize and Double Oversize or 263-400 for Triple Oversize 1/2-20 Drain Plugs. For 'E-Z' Seal Oil Drain Plugs see page 122.

papeco OIL PAN BOLTS

Replacement bolts for lost or broken oil or transmission pans. Type 4 oversized bolts for cutting new threads in stripped transmission or oil pan mounting holes. Special chip clearing point.

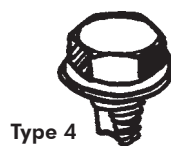
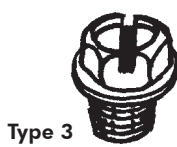
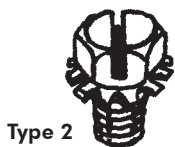
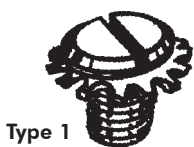

Standard Package 25 Pieces

| Stock No. | Size | Type |
|-----------|----------------|------|
| 263-001 | 1/4-20 x 7/16 | 1 |
| 263-002 | 1/4-20 x 7/16 | 2 |
| 263-003 | 5/16-18 x 9/16 | 2 |
| 263-004 | 5/16-18 x 1/2 | 3 |
| 263-005 | 1/4-20 x 1/2 | 3 |
| 263-006 | 5/16-18 x 5/8 | 3 |
| 263-010 | M6x1.0 x 14mm | 3 |
| 263-011 | M8x1.25 x 14mm | 3 |
| 263-020 | 1/4-20 x 1/2 | 4 |
| 263-021 | 5/16-18 x 5/8 | 4 |
| 263-022 | M6x1.0 x 14mm | 4 |
| 263-023 | M8x1.25 x 14mm | 4 |

252
Series

papco BRASS BRAKE BLOCK BOLTS
BOULONS POUR SABOT DE FREIN



252-221
252-354

'Papco' Brass Brake Lining Fasteners, No. 252-221 and No. 252-354 are used to replace rivets on many truck and trailer applications. The 3/8" Diameter Brass Bolts are used on Brake Blocks. In each case the screw is Brass to avoid scoring and the hexagon nuts and lock washers are steel.

252-489
252-491
252-493



Order by Stock Number

Standard Package Contains 100 assemblies.

| Stock No. | Size | Description |
|-----------|-----------------|---|
| 252-221 | 10-32 x 1" | Spec. Flat Brass Screw, Hex. Steel Nut, Lock Washer |
| 252-354 | 1/4-28 x 1" | Spec. Flat Brass Screw, Hex. Steel Nut, Lock Washer |
| 252-489 | 3/8-16 x 1" | Flat Head Brass Screw, Hexagon Steel Nut |
| 252-491 | 3/8-16 x 1-1/4" | Flat Head Brass Screw, Hexagon Steel Nut |
| 252-493 | 3/8-16 x 1-1/2" | Flat Head Brass Screw, Hexagon Steel Nut |

260
Series

papco SQUARE HEAD PIPE PLUGS
BOUCHONS DE TUYAU TETE CARRE



With LOCTITE® Vibra-Seal®

These forged steel pipe plugs are used as drain and filler plugs on all cars, trucks, tractors and stationary engines. Made with Dryseal American National Pipe Threads. For improved reliability 'Papco' Pipe Plugs feature LOCTITE® Vibra-Seal® pre-applied thread sealant.



Order by Stock Number

Standard Package 12 plugs

| Iron Pipe Size | 1/8-27 Thread | 1/4-18 Thread | 3/8-18 Thread | 1/2-14 Thread | 3/4-14 Thread |
|--------------------------------|---------------|---------------|---------------|---------------|---------------|
| Stock No. | 260-901 | 260-902 | 260-903 | 260-904 | 260-906 |
| Approximate Diameter Small End | 3/8" | 1/2" | 5/8" | 7/8" | 1" |

SQUARE HEAD PIPE PLUG GARAGE ASSORTMENT

No. 020-043

Contains 20 Square Head Pipe Plugs in 1/8, 1/4 and 3/8 iron pipe sizes. Packed in a clear, plastic box.



SOCKET PIPE PLUG GARAGE ASSORTMENT

No. 020-087

Contains 20 Socket Pipe Plugs in 1/8, 1/4 and 3/8 iron pipe sizes. Packed in a sturdy, transparent, plastic box.

SQUARE HEAD PIPE PLUG UTILITY ASSORTMENT
No. 020-332

Contains 42 Square Head Pipe Plugs in 1/8, 1/4, 3/8 and 1/2 pipe sizes. Packed in a sturdy fibreboard container with moulded compartments.

papco SOCKET PIPE PLUGS
BOUCHONS DE TUYAU CREUX



260
Series

Hexagon Socket Steel Plugs with LOCTITE® Vibra-Seal® pre-applied thread sealant.



Order by Stock Number

Standard Package 12 plugs

| Iron Pipe Size | 1/8-27 Thread | 1/4-18 Thread | 3/8-18 Thread | 1/2-14 Thread |
|----------------|---------------|---------------|---------------|---------------|
| Stock No. | 260-921 | 260-922 | 260-923 | 260-924 |



300
Series

papeo® SLOTTED SPRING PINS GOUPILLES RESSORT FENDUE

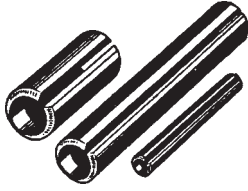

These high-carbon spring steel pins replace dowel pins, straight pins, taper and groove pins. They can be driven into an ordinary drilled hole and will hold position due to their spring action - no peening or rivetting. Re-usable - easy to insert and remove. Shock resistant, vibration proof - stronger than solid pins. Spring pins are oversize, they contract when inserted in the nominal size drill hole.

Order by Stock Number

Standard Package Contains 50 Pins

| Stock No. | Nom. Dia. x Length | Stock No. | Nom. Dia. x Length | Stock No. | Nom. Dia. x Length | Stock No. | Nom. Dia. x Length |
|-----------|--------------------|-----------|--------------------|-----------|--------------------|-----------|--------------------|
| 300-038 | 1/16 x 3/16 | 300-091 | 3/32 x 1 | 300-189 | 3/16 x 1/2 | 300-313 | 1/4 x 1-1/2 |
| 300-040 | 5/16 | 300-093 | 1-1/4 | 300-190 | 5/8 | 300-315 | 1-3/4 |
| 300-043 | 1/2 | 300-095 | 1-1/2 | 300-191 | 3/4 | 300-316 | 2 |
| 300-044 | 5/8 | 300-134 | 1/8 x 3/8 | 300-193 | 1 | 300-317 | 2-1/4 |
| 300-045 | 3/4 | 300-137 | 1/2 | 300-195 | 1-1/4 | 300-318 | 2-1/2 |
| 300-046 | 7/8 | 300-138 | 5/8 | 300-197 | 1-1/2 | 300-442 | 5/16 x 3/4 |
| 300-047 | 1 | 300-139 | 3/4 | 300-199 | 1-3/4 | 300-443 | 7/8 |
| 300-059 | 5/64 x 1/4 | 300-140 | 7/8 | 300-200 | 2 | 300-444 | 1 |
| 300-063 | 1/2 | 300-141 | 1 | 300-201 | 2-1/4 | 300-448 | 1-1/2 |
| 300-064 | 9/16 | 300-143 | 1-1/4 | 300-247 | 7/32 x 5/8 | 300-450 | 1-3/4 |
| 300-065 | 3/4 | 300-145 | 1-1/2 | 300-252 | 1-1/4 | 300-451 | 2 |
| 300-067 | 1 | 300-147 | 1-3/4 | 300-253 | 1-3/8 | 300-453 | 2-1/2 |
| 300-069 | 1-1/4 | 300-148 | 2 | 300-254 | 1-1/2 | 300-487 | 3/8 x 3/4 |
| 300-071 | 1-1/2 | 300-163 | 5/32 x 1/2 | 300-256 | 1-3/4 | 300-489 | 1 |
| 300-084 | 3/32 x 5/16 | 300-164 | 5/8 | 300-306 | 1/4 x 5/8 | 300-493 | 1-1/2 |
| 300-087 | 1/2 | 300-165 | 3/4 | 300-307 | 3/4 | 300-496 | 2 |
| 300-088 | 5/8 | 300-167 | 1 | 300-308 | 7/8 | 300-498 | 2-1/2 |
| 300-089 | 3/4 | 300-169 | 1-1/4 | 300-309 | 1 | 300-500 | 3 |
| 300-090 | 7/8 | 300-171 | 1-1/2 | 300-311 | 1-1/4 | | |



papeo SPRING PIN ASSORTMENTS

Automotive uses include Drive Shaft Coupling Pins, gear shift lever pins, pump shaft pins, window regulator pins, door handle retaining pins, automatic transmission pins, etc. Also used in Agricultural Machinery and Farm equipment.

UTILITY ASSORTMENT No. 020-319

Contains 116 pins, 12 sizes. Packed in a sturdy fibre board box with illustrated lid label showing retail price codes.

SPRING PIN MASTER ASSORTMENT No. 020-642

Contains 275 Pins, 20 popular sizes in a metal box with moulded plastic compartments, hinged lid, carrying handle and safety snap lock. Useful for construction and farm equipment dealers.

Size: 9-3/4" w. x 13-3/4" l. x 2" d.

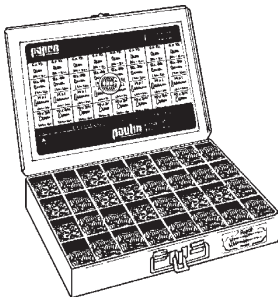

papeo SUPER SERVICE ASSORTMENT No. 020-819

Contains 770 Spring Pins - 32 sizes.
Large size, rigid metal box with high-strength plastic compartments.

For more details see page 9.

Large size: 12" w. x 18" l. x 3" d.

302
Series

papco WOODRUFF KEYS
CLAVETTES 'WOODRUFF'



'Papco' WOODRUFF KEYS are made from S.A.E. 1035 Carbon Steel. They are used on armature shafts of starters and generators, etc.

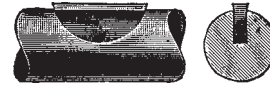

Order by Stock Number

Standard Package 25 Keys

| Stock No. | Size Width x Dia. | Stock No. | Size Width x Dia. | Stock No. | Size Width x Dia. | Stock No. | Size Width x Dia. |
|-----------|-------------------|-----------|-------------------|-----------|-------------------|-----------|-------------------|
| 302-010 | 1/16 x 1/2 | 302-091 | 1/4 x 3/4 | 302-170 | 7/32 x 1-1/8 | 302-236 | 3/8 x 1-3/8 |
| 302-020* | 3/32 x 1/2 | 302-100* | 5/32 x 7/8 | 302-180* | 1/4 x 1-1/8 | 302-240 | 1/4 x 1-1/2 |
| 302-030* | 1/8 x 1/2 | 302-110* | 3/16 x 7/8 | 302-183 | 5/16 x 1-1/8 | 302-250 | 5/16 x 1-1/2 |
| 302-040* | 3/32 x 5/8 | 302-120 | 7/32 x 7/8 | 302-190 | 3/16 x 1-1/4 | 302-257 | 3/8 x 1-1/2 |
| 302-050* | 1/8 x 5/8 | 302-121 | 1/4 x 7/8 | 302-200 | 7/32 x 1-1/4 | 302-270 | 1/4 x 2-1/8 |
| 302-060* | 5/32 x 5/8 | 302-130* | 3/16 x 1 | 302-210 | 1/4 x 1-1/4 | 302-280 | 5/16 x 2-1/8 |
| 302-061 | 3/16 x 5/8 | 302-140 | 7/32 x 1 | 302-214 | 5/16 x 1-1/4 | 302-290 | 3/8 x 2-1/8 |
| 302-070 | 1/8 x 3/4 | 302-150* | 1/4 x 1 | 302-215 | 3/8 x 1-1/4 | 302-291 | 3/8 x 2-3/4 |
| 302-080* | 5/32 x 3/4 | 302-152 | 5/16 x 1 | 302-220 | 1/4 x 1-3/8 | 302-292 | 5/16 x 2-3/4 |
| 302-090* | 3/16 x 3/4 | 302-160 | 3/16 x 1-1/8 | | | | |

*Denotes popular sizes

Sizes not listed can be supplied.

papco WOODRUFF KEY ASSORTMENTS
ASSORTIMENTS CLAVETTES 'WOODRUFF'

GARAGE ASSORTMENT No. 020-020



This assortment contains 100 Woodruff keys in 12 sizes that are needed in every garage. Packed in a sturdy, plastic box.

GARAGE ASSORTMENT No. 020-021

This assortment contains 29 of the following Large size Woodruff Keys. 302-190, 200, 210, 214, 215, 220, 240, 250, 257, 270, 280, 290, 291, 292.



For complete coverage of most tractors and farm machinery use the 020-020 Woodruff Key Assortment together with 020-021.

WOODRUFF KEY MASTER ASSORTMENT No. 020-614

- Contains 210 Woodruff Keys.
- 20 popular sizes.
- Metal box with moulded plastic compartments.
- Actual size illustrations on lid label.
- Refills available in standard packages.
- Sizes: 302-010, 020, 030, 040, 050, 060, 070, 080, 090, 100, 110, 121, 130, 150, 152, 160, 180, 200, 210, 240.



Metal Merchandiser with moulded compartments.

Size: 9-3/4" w. x 13-3/4" l. x 2" d.

A popular Assortment for Garages, Machine Shops and Implement repair use.

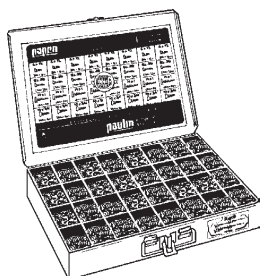

papco SUPER SERVICE ASSORTMENT No. 020-820

Contains 374 Woodruff Keys - 32 sizes. Large size, rigid metal box with high-strength plastic compartments.

For more details see page 9.

Large size: 12" w. x 18" l. x 3" d.



304
Series

Papco UNIVERSAL 'O'-RINGS JOINTS TORIQUES UNIVERSEL

Popular standard sizes used in automotive, agricultural and industrial equipment maintenance. 'Papco' O-Rings are made of a special Nitrile Compound (Buna-N Rubber) for petroleum oils, greases, automotive gasoline, alcohols, glycols, fuel oil, propane and many other fluids.

Assembly instructions: Be sure all parts are perfectly clean. Then lubricate the O-Ring. For an external groove, stretch the ring over the shaft or fold the ring into an internal groove. Avoid excessive twisting.

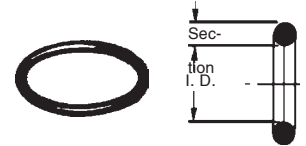

Order by Stock Number

Standard Package contains 25 'O' Rings

| Stock No. | Nominal Size | | | Stock No. | Nominal Size | | |
|-----------|--------------|--------|---------|-----------|--------------|---------|---------|
| | I.D. | O.D. | Section | | I.D. | O.D. | Section |
| 304-001 | 1/8 | 1/4 | 1/16 | 304-022 | 1-3/16 | 1-7/16 | 1/8 |
| 304-002 | 5/32 | 9/32 | 1/16 | 304-023 | 1-1/4 | 1-1/2 | 1/8 |
| 304-003 | 3/16 | 5/16 | 1/16 | 304-024 | 1-5/16 | 1-9/16 | 1/8 |
| 304-004 | 7/32 | 11/32 | 1/16 | 304-025 | 1-3/8 | 1-5/8 | 1/8 |
| 304-005 | 1/4 | 3/8 | 1/16 | 304-026 | 1-7/16 | 1-11/16 | 1/8 |
| 304-006 | 5/16 | 7/16 | 1/16 | 304-027 | 1-1/2 | 1-3/4 | 1/8 |
| 304-007 | 3/8 | 1/2 | 1/16 | 304-028 | 1-1/2 | 1-7/8 | 3/16 |
| 304-008 | 3/8 | 9/16 | 3/32 | 304-029 | 1-5/8 | 2 | 3/16 |
| 304-009 | 7/16 | 5/8 | 3/32 | 304-030 | 1-3/4 | 2-1/8 | 3/16 |
| 304-010 | 1/2 | 11/16 | 3/32 | 304-031 | 1-7/8 | 2-1/4 | 3/16 |
| 304-011 | 9/16 | 3/4 | 3/32 | 304-033 | 2-1/8 | 2-1/2 | 3/16 |
| 304-012 | 5/8 | 13/16 | 3/32 | 304-035 | 2-3/8 | 2-3/4 | 3/16 |
| 304-013 | 11/16 | 7/8 | 3/32 | 304-037 | 2-5/8 | 3 | 3/16 |
| 304-014 | 3/4 | 15/16 | 3/32 | | | | |
| 304-015 | 3/4 | 1 | 1/8 | | | | |
| 304-016 | 13/16 | 1-1/16 | 1/8 | | | | |
| 304-017 | 7/8 | 1-1/8 | 1/8 | | | | |
| 304-018 | 15/16 | 1-3/16 | 1/8 | | | | |
| 304-019 | 1 | 1-1/4 | 1/8 | | | | |
| 304-020 | 1-1/16 | 1-5/16 | 1/8 | | | | |
| 304-021 | 1-1/8 | 1-3/8 | 1/8 | | | | |

UNIVERSAL 'O' RING GARAGE ASSORT. No. 020-072



Contains 78 rings, 15 sizes from 1/8" to 3/4" I.D. Packed in a clear plastic box.

UNIVERSAL 'O' RINGMASTER ASSORTMENT No. 020-626

Contains 300 rings, 30 sizes, in sturdy metal box with locking lid and carrying handle. Illustrated label with actual size illustrations to make correct selection easy. Size: 9-3/4" w. x 13-3/4" l. x 2" d.



020-626

UNIVERSAL 'O' RING ASSORTMENT No. 020-960

Contains 382 rings, 30 sizes from 1/8" to 1-3/4" I.D. Popular assortment of inch-series. 'O' Rings packed in a durable ABS plastic dispensing box with individual posts and compartments, and with a cross-section (thickness) moulded gauge. Size chart is shown on cover.

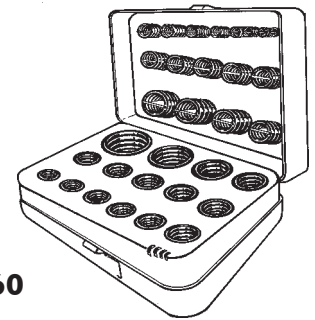

020-960

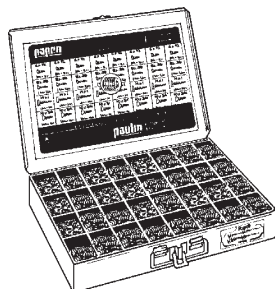

Papco SUPER SERVICE ASSORTMENT No. 020-821

Contains 390 'O' Rings - 30 sizes. Large size, rigid metal box with high-strength plastic compartments. For more details see page 9. Large size: 12" w. x 18" l. x 3" d.



313
Series

papeco AXLE SHAFT KEY STOCK
BARRES DE CLEF

'Papco' AXLE KEY STOCK IN 12" lengths enables the mechanic to make up any size axle key on short notice and with a minimum investment. Standard Package contains six 12" lengths.

AXLE KEY STOCK ASSORTMENT
No. 020-853

Contains 20 Lengths of Key Stock in all popular sizes.

All 12" Long



Order by Stock Number

| Stock No. | Size | Stock No. | Size |
|-----------|-------------|-----------|------------|
| 313-174 | 3/16 x 3/16 | 313-180 | 1/2 x 1/2 |
| 313-176 | 1/4 x 1/4 | 313-181 | 1/4 x 5/16 |
| 313-177 | 5/16 x 5/16 | 313-182 | 1/4 x 3/8 |
| 313-178 | 3/8 x 3/8 | 313-183 | 5/16 x 3/8 |
| 313-179 | 7/16 x 7/16 | 313-185 | 3/8 x 7/16 |



ASSORTMENT No. 020-906

This handy assortment contains 50 lengths - 10 each of 3/16", 1/4", 5/16", 3/8" and 1/2" sq. x 12" long Axle Key Stock. Make your own keys for axle shafts, pulley shafts and many other applications where a straight key is needed. Attractive, all-metal merchandiser can stand on counter or hang on wall.

papeco HOLE (BUTTON) PLUGS
BOUCHONS DE TROU

314
Series

Used to plug holes in instrument panel, cowl, fire wall, etc. Made of nickel plated steel with spring action prongs. They snap into place and can be removed and re-inserted.



Order by Stock Number Standard package 50 Plugs

| Stock No. | Fits Hole Size | Stock No. | Fits Hole Size |
|-----------|----------------|-----------|----------------|
| 314-018 | 3/8" | 314-026 | 3/4" |
| 314-020 | 7/16" | 314-030 | 1" |
| 314-022 | 1/2" | 314-034 | 1-1/4" |
| 314-024 | 5/8" | | |

For Plastic Button Plugs see page 107.



GARAGE ASSORTMENT No. 020-028

Contains 47 hole plugs, including each of the sizes listed. Ideal for plugging aerial, accessory or switch holes. Packed in clear plastic container.

314
Series

papeco MECHANICS' WIRE
BROCHE DE MECANICIEN

STOVE PIPE WIRE

'Papco' Mechanics' Wire is soft annealed for general use in garage or workshop. Used as locking wire in drilled bolts in bearings and flywheels.

Packed on sturdy plastic spools - saves time - eliminates waste.

Order by Stock Number

| Stock No. | Two Pound Spools |
|-----------|----------------------------------|
| 314-218 | 18 ga. (.047") 330 ft. per spool |

Note: Length shown is approximate.





312
Series

papco

TAPER PINS
GOUPILLES CONIQUE



Standard Taper 1/4" per foot or .0208" per inch.
Diameter is measured at the large end.

Order by Stock Number

Standard Package 25 pieces.

| Stock No. | Dia. And Length | Dia. Large End. | Approx. Dia. | Stock No. | Dia. And Length | Dia. Large End. | Approx. Dia. |
|-----------|-----------------|-----------------|--------------|-----------|-----------------|-----------------|--------------|
| 312-001 | 00 x 1" | .141 | 9/64 | 312-014 | 4 x 1-1/2" | .250 | 1/4 |
| 312-002 | 00 x 1-1/2" | .141 | 9/64 | 312-015 | 4 x 2" | .250 | 1/4 |
| 312-003 | 0 x 1" | .156 | 5/32 | 312-016 | 4 x 2-1/2" | .250 | 1/4 |
| 312-004 | 0 x 1-1/2" | .156 | 5/32 | 312-017 | 5 x 1-1/2" | .289 | 19/64 |
| 312-005 | 1 x 1" | .172 | 11/64 | 312-018 | 5 x 1-3/4" | .289 | 19/64 |
| 312-006 | 1 x 1-1/2" | .172 | 11/64 | 312-019 | 5 x 2" | .289 | 19/64 |
| 312-007 | 1 x 2" | .172 | 11/64 | 312-020 | 5 x 2-1/2" | .289 | 19/64 |
| 312-008 | 2 x 1-1/4" | .193 | 3/16 | 312-021 | 6 x 2" | .341 | 11/32 |
| 312-009 | 2 x 1-1/2" | .193 | 3/16 | 312-022 | 6 x 2-1/2" | .341 | 11/32 |
| 312-010 | 2 x 2" | .193 | 3/16 | 312-023 | 6 x 3" | .341 | 11/32 |
| 312-011 | 3 x 1-1/4" | .219 | 7/32 | 312-024 | 7 x 2-1/2" | .409 | 13/32 |
| 312-012 | 3 x 1-1/2" | .219 | 7/32 | 312-025 | 7 x 3" | .409 | 13/32 |
| 312-013 | 3 x 2" | .219 | 7/32 | | | | |

Taper Pins Sizes No. 7/0 to No. 10 can be supplied.

GARAGE ASSORTMENT No. 020-050

Contains 46 Taper Pins. 18 sizes from 312-001 to 020. Needed in every garage. Packed in Plastic Box.

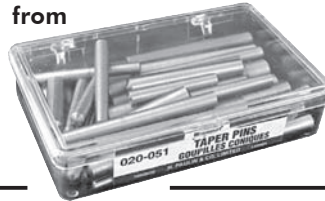

GARAGE ASSORTMENT No. 020-051

For farm Equipment use. Contains 36 Taper Pins. 10 sizes from 312-014 to 025. These large size pins are for Tractor and Farm implement use. Combine with Asst. No. 020-050 for complete coverage.



MASTER ASSORTMENT No. 020-610

Contains 100 Taper Pins 20 sizes from 2/0 x 1" to No. 6 x 3". Packed in an all metal container with hinged lid and carrying handle.



Straight Parallel Type

papco **AXLE KEYS**
BARRES DE CLEF

313
Series

'Papco' Axle Keys are made from special S.A.E. Key Steel, supplied in various sizes to service all cars and trucks.

Order by Stock Number

Standard Package contains 12 Axle Keys

| Stock No. | Size | Stock No. | Size | Stock No. | Size |
|-----------|--------------------|-----------|---------------------|-----------|--------------------|
| 313-078 | 3/16 x 3/16 x 1 | 313-115 | 1/4 x 5/16 x 3-1/4 | 313-139 | 1/4 x 3/8 x 3-1/4 |
| 313-105 | 1/4 x 1/4 x 2-7/8 | 313-124 | 5/16 x 5/16 x 2-3/4 | 313-144 | 5/16 x 3/8 x 3-3/4 |
| 313-107 | 1/4 x 1/4 x 3-1/8 | 313-127 | 5/16 x 5/16 x 3-1/8 | 313-147 | 5/16 x 7/16 x 3 |
| 313-111 | 1/4 x 5/16 x 2-1/2 | 313-136 | 1/4 x 3/8 x 2-5/8 | 313-152 | 3/8 x 3/8 x 3-3/4 |

AXLE KEY ASSORTMENT
No. 020-862

This assortment contains 40 keys made up of the 12 sizes listed above.





■ **QUALITY**

"301" Stainless Steel Band and Housing.
Hi-strength Hex Plated Steel Screw.
No loose parts.

■ **EASY TO USE**

Goes on with Hose in position.
Combination Hex Screw tightens with screw Driver or Wrench.

307 Series



308 Series

■ **RANGE**

Wide size range for each clamp.

■ **STRENGTH**

Wide band for even pressure.
Won't cut hose.
Full-formed teeth will never slip.

■ **ALL STAINLESS STEEL
308 Series**

'Papco' 'Sealtite' Hose Clamps are manufactured from the highest quality materials for reliable operation in any Automotive or Industrial applications. The aircraft principle of the Worm Gear drive gives this clamp a powerful sealing action that meets the toughest requirements. Standard clamp features '301' (18.8) Stainless Steel band and housing with a zinc plated steel screw. The All-Stainless Steel clamp Features a '301' (18.8) Stainless Steel band and housing with a '305' Stainless Steel Screw.

Standard Package contains 10 Hose Clamps

| Part Number | | Nominal Size | Fits Hose O.D. | Part Number | | Nominal Size | Fits Hose O.D. |
|-------------|---------------|--------------|------------------|-------------|---------------|--------------|--------------------|
| Standard | All-Stainless | | | Standard | All-Stainless | | |
| 307-001 | 308-001 | 5/16" | 7/32" - 5/8" | 307-032 | 308-032 | 2" | 1-9/16" - 2-1/2" |
| 307-002 | 308-002 | 7/16" | 5/16" - 7/8" | 307-036 | 308-036 | 2-1/4" | 1-13/16" - 2-3/4" |
| 307-008 | 308-008 | 1/2" | 7/16" - 15/16" | 307-040 | 308-040 | 2-1/2" | 2-1/16" - 3" |
| 307-010 | 308-010 | 5/8" | 9/16" - 1-1/16" | 307-044 | 308-044 | 2-3/4" | 2-5/16" - 3-1/4" |
| 307-012 | 308-012 | 3/4" | 5/8" - 1-1/4" | 307-048 | 308-048 | 3" | 2-9/16" - 3-1/2" |
| 307-016 | 308-016 | 1" | 11/16" - 1-1/2" | 307-052 | 308-052 | 3-1/4" | 2-13/16" - 3-3/4" |
| 307-020 | 308-020 | 1-1/4" | 13/16" - 1-3/4" | 307-056 | 308-056 | 3-1/2" | 3-1/16" - 4" |
| 307-024 | 308-024 | 1-1/2" | 1-1/6" - 2" | 307-060 | 308-060 | 3-3/4" | 3-5/16" - 4-1/4" |
| 307-028 | 308-028 | 1-3/4" | 1-5/16" - 2-1/4" | 307-064 | 308-064 | 4" | 3-13/16" - 4-1/16" |

papeco **HOSE CLAMP 'FLEX-DRIVER'**

No. 307-100



This handy tool makes short work of clamp installation and removal in 'hard-to-reach' places. High quality, flexible Swedish steel shaft with a 5/16" hex socket and a durable, plastic handle for comfort and maximum torque. Includes two 5/8" heater hose clamps. Eliminates slipping and stripping of hose clamp screws. Individually skin-packed on a colourful point-of-purchase display card.

BONUS
Two 5/8" Sealtite Hose Clamps

For 'Hard-to-reach' places!



papeco
'SEALTITE' HOSE CLAMPS

Convenient skin-packed cards contain two (2) 'Sealtite' Worm Gear Hose Clamps.

Order by Card Number

| Card No. | Nominal Size | Fits Hose O.D. |
|----------|--------------|------------------|
| 307-101 | 5/16" | 7/32" - 5/8" |
| 307-110 | 5/8" | 9/16" - 1-1/16" |
| 307-116 | 1" | 11/16" - 1-1/2" |
| 307-124 | 1-1/2" | 1-1/16" - 2" |
| 307-132 | 2" | 1-9/16" - 2-1/2" |



Papco 'SNAPPER' HOSE CLAMPS COLLIERS DE BOYAUX 'SNAPPER'

'Papco' Nylon 6/6 Snapper Hose Clamps form an instant grip on hoses in automobile repair or whenever a quick application is required. Teeth mesh together and are set by using pliers and released by sliding jaws sideways. Will not rust - non-conductive. For pressures up to 120 p.s.i. UV stabilized.

Order by Stock Number

Standard Package 10 Clamps

| Stock No. | Fits Hose I.D. | Clamp Range | | Stock No. | Fits Hose I.D. | Clamp Range | |
|-----------|----------------|-------------|---------|-----------|----------------|-------------|----------|
| | | Minimum | Maximum | | | Minimum | Maximum |
| 307-505 | 5/16" | 19/64" | 11/32" | 307-516 | 1" | 63/64" | 1-9/64" |
| 307-506 | 3/8" | 23/64" | 25/64" | 307-517 | 1-1/8" | 1-1/8" | 1-19/64" |
| 307-507 | 7/16" | 13/32" | 29/64" | 307-519 | 1-3/16" | 1-7/32" | 1-13/64" |
| 307-508 | 1/2" | 33/64" | 19/32" | 307-520 | 1-1/4" | 1-9/32" | 1-19/32" |
| 307-509 | 9/16" | 9/16" | 21/32" | 307-522 | 1-1/2" | 1-15/32" | 1-23/32" |
| 307-510 | 5/8" | 39/64" | 45/64" | 307-524 | 1-3/4" | 1-47/64" | 2-1/64" |
| 307-512 | 3/4" | 3/4" | 27/32" | 307-526 | 2" | 2" | 2-15/64" |
| 307-513 | 13/16" | 25/32" | 29/32" | 307-528 | 2-1/4" | 2-1/4" | 2-37/64" |
| 307-514 | 7/8" | 55/64" | 63/64" | | | | |



Papco FUEL INJECTION HOSE CLAMPS COLLIERS DE BOYAUX POUR INJECTEUR D'ESSENCE

Manufactured specifically for all fuel injection applications. Non-perforated band is aluzinc coated carbon steel with a zinc plated carbon steel screw and nut. Band width approx. 3/8".

Order by Stock Number

Standard Package 10 Clamps

| Stock No. | Fits Hose I.D. | Clamp Range | | Stock No. | Fits Hose I.D. | Clamp Range | |
|-----------|----------------|-------------|---------|-----------|----------------|-------------|---------|
| | | Minimum | Maximum | | | Minimum | Maximum |
| 307-550 | 1/4" | 7/16" | 1/2" | 307-552 | 3/8" | 9/16" | 5/8" |
| 307-551 | 5/16" | 1/2" | 19/32" | | | | |

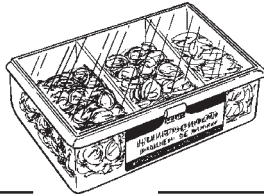

FUEL INJECTION HOSE CLAMP GARAGE ASSORTMENT No. 020-096

Contains 28 Hose Clamps - 3 sizes in a compartmentized, clear styrene plastic box.

Papco CONSTANT TENSION HOSE CLAMPS COLLIERS DE BOYAUX A TENSION CONSTANTE



Metal pinch or squeeze type clamp commonly used on fuel, vacuum and other low pressure lines.

Order by Stock Number

Std. Pkg. 25 Clamps

| Stock No. | Fits Hose O.D. | Max. Clamp Dia. Open | Colour |
|-----------|----------------|----------------------|--------|
| 307-560 | 3/8" | .321 | Black |
| 307-561 | 7/16" | .405 | Green |
| 307-562 | 1/2" | .460 | Red |
| 307-564 | 5/8" | .583 | Olive |
| 307-566 | 3/4" | .645 | Black |
| 307-568 | 1" | .910 | Black |

CONSTANT TENSION HOSE CLAMP GARAGE ASSORTMENT No. 020-097

Contains 60 Clamps - 6 sizes packed in a transparent, plastic container with a hinged lid.

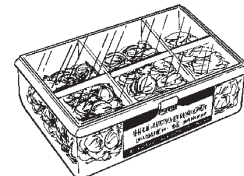

310
Series

papeo

PUSH-PULL CONTROLS
CABELES DE CONTROL



For choke, throttle, hood, air vents, heater valves, mowers, snow blowers, power take-off etc.
All controls are individually packaged for point of sale display. Order by Stock Number.

UTILITY CONTROLS

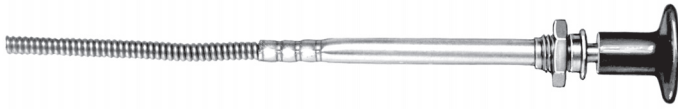

Round black knob to complete any dash panel.
2" travel, 3/16 OD. Gal. Casing, .054" HC Wire, 3/8-24 housing thread
Stock No. 310-120 60" long
Stock No. 310-121 72" long

STANDARD ASSEMBLIES



Round lustrous black knob. Includes mounting bracket and finishing washer Plated.
2" travel, 3/16 OD. Casing, .054" HC Wire, 3/8-24 housing thread
Stock No. 310-136 180" long

'T' HANDLE ASSEMBLY

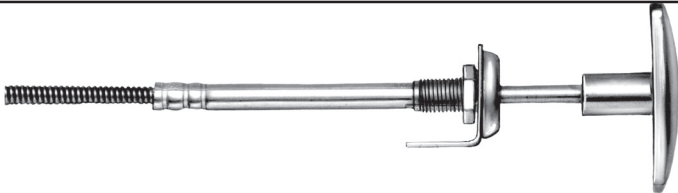

Chrome plated metal handle. Plated assembly. Includes mounting bracket and finishing washer.
2" travel, 3/16 OD. Casing, .054" HC Wire, 3/8-24 housing thread
Stock No. 310-152 84" long

'T' HANDLE HEAVY DUTY LOCKING ASSEMBLY

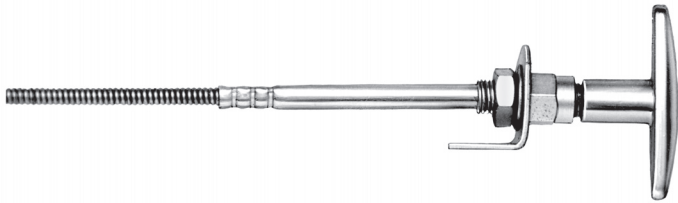

Locks with half turn. Brass Clutch. Chrome Handle. Includes dash mount bracket and finishing washer. Full floating core does not turn with handle.
2" travel, 3/16 OD. Casing, .062" HC Wire, 3/8-24 housing thread
Stock No. 310-173 Heavy Duty Housing. 108" long

'T' HANDLE HEAVY DUTY LOCKING ASSEMBLY

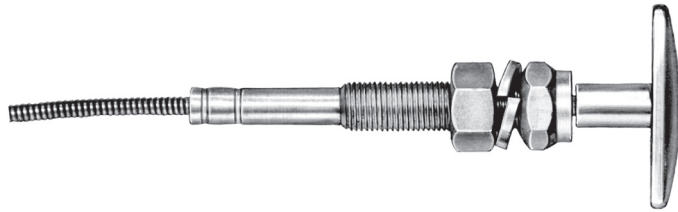

Turn and lock. Brass locking clutch. Chrome Handle. Plated. Heavy Duty Housing with 2" thread length. Full floating core wire.
2" travel, 3/16 OD. Casing, .062" HC Core Wire, 1/2-20 housing thread
Stock No. 310-181 72" long

MARINE CONTROL



For boats, other marine and hostile environment applications. Casting is 3/16" dia. REINFORCED NYLON. 'T' Handle is chrome plated. Brass housing. Full floating core wire.
2" travel, 3/16" Vinyl Coated casing w/HDPE Liner, .062" Stainless Core Wire, 3/8-24 housing thread.
Stock No. 310-183 108" long

POWER TAKE OFF CONTROLS



Used primarily as dash mounted power takeoff control on trucks and mobile equipment. Nylon lined, metal reinforced vinyl casing. Plated for corrosion resistance. Large 2" dia. round plastic knob. 7/16-20 x 1-1/2" long housing. Includes mounting nut and lock washer. Individually boxed.
4" travel, 5/16" Vinyl Coated Casing, .093" Stainless Core Wire, 7/16-20 housing thread
Stock No. 310-194 120" long
Stock No. 310-198 240" long



310
Series

papeo® HEAVY DUTY VERNIER CONTROL CONTROLE VERNIER EXTRA-ROBUSTE

Recommended for heavy truck, bus, agricultural and off-highway uses. Heavy duty easy-action control for critical adjustments. This accurate Vernier control has a unique three prong locking collar. Designed for one-hand setting and locking in place. Make accurate fine adjustments by rotating knob - depress

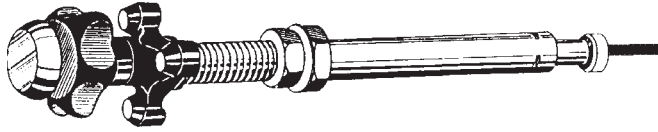

central button and push or pull for coarse setting. Long life working parts are brass and stainless, weather resistant 5/16" O.D. reinforced vinyl casing and liner. .072" stainless steel core wire x 120" long. Housing is 3/4-16 x 2 9/16" long with hex panel nut, mounting nut and lock washer. Travel is 3 5/8".

Stock No. 310-216

120" long

Individually boxed

CHOKE CONVERSION KITS TROUSSES DES CONVERSION A L'ETRANGLEUR

Helps eliminate hard winter starts. Allows driver to control choke. Instant control of air and gas mixture from dash.

Order by Stock Number

Complete instructions included.

Individually Packaged

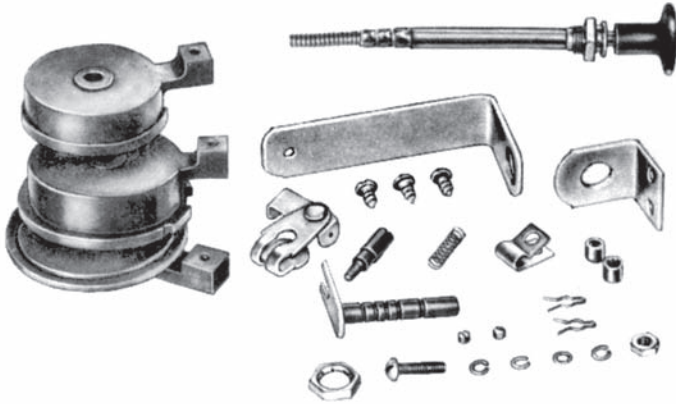

No. 310-245
No. 310-246
No. 310-250

SEMI-AUTOMATIC TYPE
MANUAL TYPE

SEMI-AUTOMATIC TYPE

Allows manual override. Exclusive "Magic-Link" lets engine breathe even under full choke.

Stock No. 310-245
Fits AMC, GM, Ford and Chrysler cars. 60" cable.

Stock No. 310-246
Fits all light and medium domestic trucks. Has long 108" cable.

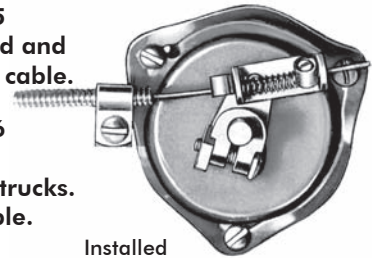

Installed

COMPLETE MANUAL OPERATION

Stock No. 310-250
Universal kit. For most American made cars. Cable is 60" long

UNIVERSAL SPEEDOMETER CABLE KIT TROUSSE DE CABLE POUR INDICATEUR DE VITESSE

This complete kit includes 81" long standard multi-strand flexible shafting with .104" squared lower end. Cut shafting to length of original speedometer cable and attach the square tip with the staking tool provided. Fits most cars, trucks and RV's.

Stock No. 310-281

Individually Packaged

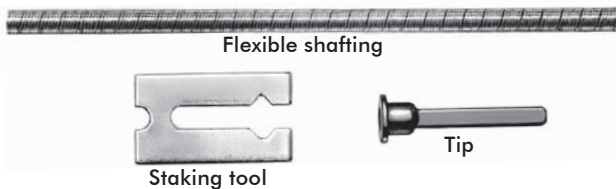

Flexible shafting



Staking tool



Tip

81" Flexible shafting, tip and tool.

Stock No. 310-281

CONTROL WIRE STOPS BLOQUEURS POUR CONTROLE DE BROCH

Universal type. For push-pull controls, choke control wires, hood release latches and throttle cables. Position cable stop against control arm of lever and tighten screw.

Order by Stock Number

Standard Package 25 pieces

Stock No. 310-353



1/4" for 1-16" wire

Stock No. 310-354



3/8" for 1/8" wire



CARBURETOR and THROTTLE RETURN SPRINGS RESSORTS DE CARBURATEUR et SOUPAPE DE REGLAGE



Stock No.
311-001

Universal Throttle Return Spring. Can be adapted for use on all Carburetors and Accelerator pedals. Spring measures 12" overall and plain end can be cut to required length. Standard Package contains 12 springs.

Stock No.
311-002

Carburetor Return Spring. Attach to screw on carburetor body and hook to throttle valve arm. Acts as a helper spring for throttle return - prevents racing and sticking accelerator. For Chevrolet, G.M. and Chrysler cars. 12 Springs per package.



CARBURETOR SPRING DISPLAY No. 020-878

Contains 12 each No. 311-001, No. 311-002 Springs Mounted on attractive three colour merchandising display card.



UNIVERSAL PEDAL RETURN SPRINGS RESSORTS REVENIR DE PEDALE UNIVERSEL

FOR ALL BRAKE AND CLUTCH PEDALS



Standard Package 12 Springs

No. 311-101, 18-1/2" overall x 13/16" O.D. x 2" Coil x 7/64" Dia. Wire.

No. 311-103, 18-1/2" overall x 3/4" O.D. x 3-1/2" Coil x 1/16" Dia. Wire.

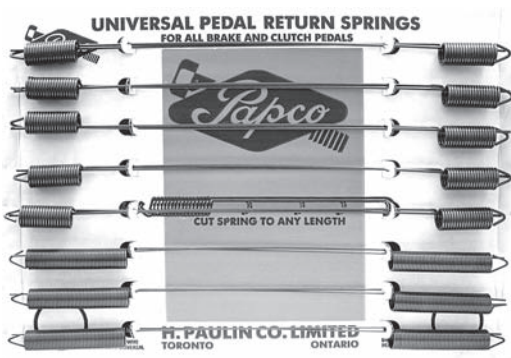

PEDAL RETURN SPRING DISPLAY No. 020-885

Contains 16 Pedal Return Springs, (10) No. 311-101, (6) No. 311-103. Mounted on attractive three colour merchandising display card. These universal springs can be cut to fit all brake and clutch pedals.



311
Series

papeo

UTILITY SPRINGS
RESSORTS D'UTILITE

Compression Type

Extension Type

In sizes suitable for most requirements

COMPRESSION TYPE



Order by Stock Number

Standard Package 12 Springs

| Stock No. | Outside Dia. | Length | Wire Size | Stock No. | Outside Dia. | Length | Wire Size |
|-----------|--------------|--------|-----------|-----------|--------------|---------|-----------|
| 311-639 | 3/32" | 7/8" | .020" | 311-601 | 3/8" | 11-1/2" | .051" |
| 311-676 | 3/16" | 5" | .026" | 311-655 | 7/16" | 2-3/4" | .045" |
| 311-615 | 1/4" | 1-1/2" | .041" | 311-622 | 7/16" | 3" | .062" |
| 311-677 | 1/4" | 5" | .034" | 311-682 | 7/16" | 5" | .062" |
| 311-618 | 9/32" | 2" | .022" | 311-683 | 1/2" | 5" | .072" |
| 311-678 | 5/16" | 5" | .047" | 311-620 | 5/8" | 2-1/2" | .081" |
| 311-679 | 5/16" | 5" | .054" | 311-646 | 5/8" | 3" | .062" |
| 311-656 | 3/8" | 2" | .034" | 311-653 | 5/8" | 3-3/8" | .080" |
| 311-650 | 3/8" | 2-3/4" | .045" | 311-602 | 5/8" | 11-1/2" | .057" |
| 311-680 | 3/8" | 5" | .054" | 311-603 | 7/8" | 10" | .081" |
| 311-681 | 3/8" | 5" | .062" | | | | |

EXTENSION TYPE



| Stock No. | Outside Dia. | Length | Wire Size | Stock No. | Outside Dia. | Length | Wire Size |
|-----------|--------------|--------|-----------|-----------|--------------|--------|-----------|
| 311-633 | 1/8" | 9/16" | .018" | 311-630 | 5/16" | 5-3/8" | .041" |
| 311-684 | 1/8" | 15/16" | .020" | 311-608 | 5/16" | 6" | .034" |
| 311-634 | 1/8" | 1-3/8" | .018" | 311-659 | 5/16" | 6-3/4" | .034" |
| 311-612 | 5/32" | 2-1/8" | .028" | 311-658 | 5/16" | 7-1/4" | .045" |
| 311-636 | 3/16" | 1-1/8" | .025" | 311-610 | 11/32" | 3" | .041" |
| 311-616 | 3/16" | 1-1/4" | .014" | 311-685 | 3/8" | 1-7/8" | .031" |
| 311-623 | 3/16" | 2-1/2" | .028" | 311-629 | 3/8" | 4-3/4" | .045" |
| 311-627 | 7/32" | 2-1/4" | .034" | 311-631 | 3/8" | 11" | .054" |
| 311-617 | 1/4" | 1-1/8" | .020" | 311-626 | 7/16" | 3-1/8" | .041" |
| 311-624 | 1/4" | 3-3/4" | .034" | 311-606 | 7/16" | 5" | .062" |
| 311-609 | 1/4" | 4" | .028" | 311-661 | 7/16" | 6-3/8" | .054" |
| 311-607 | 1/4" | 5-3/4" | .028" | 311-605 | 7/16" | 6-1/2" | .041" |
| 311-635 | 9/32" | 1-1/8" | .020" | 311-611 | 1/2" | 4-1/2" | .062" |
| 311-628 | 9/32" | 1-7/8" | .034" | 311-604 | 1/2" | 5-1/2" | .080" |
| 311-625 | 5/16" | 2-1/2" | .034" | 311-632 | 1/2" | 11" | .062" |



MASTER ASSORTMENT No. 020-637

Assortment No. 020-637 contains 250 Utility Springs, consisting of Compression, Extension and Ignition Springs. With this Assortment you will find a spring suitable for most any replacement. The attractive label shows the dimensions, stock number and list price of each spring. Refills may be ordered from standard stock.

Assortment is packed in a sturdy, sectional metal container complete with self-locking handle.



**GARAGE ASSORTMENT
No. 020-063**

Contains 100 Small Coil Springs
Compression and Extension Types included.

Packed in Plastic Box.



**EXTENSION SPRING
ASSORTMENT No. 020-860**

Contains 30 Extension Springs.
12 Popular Sizes.



**UTILITY ASSORTMENT
No. 020-342**

Contains 83 Extension and Compression Springs –
15 Popular Sizes.

Packed in a sturdy fibre-board container.



**COMPRESSION SPRING
ASSORTMENT No. 020-861**

Contains 40 Compression Springs.
12 Popular Sizes.





305
Series

papco BRASS SHIM STOCK FEUILLES POUR CALE LAITON



"Papco" BRASS SHIM STOCK is uniform and accurate in thickness, hard temper and is ideal for cutting and shaping. The 6" wide x 100" long rolls are supplied in fibre dispenser tubes for easy use.

Order by Stock Number



THREE INCH WIDTHS

36 Inch Strips

| Stock No. | Thickness | Stock No. | Thickness |
|-----------|-----------|-----------|-----------|
| 305-301 | .001 | 305-307 | .007 |
| 305-302 | .002 | 305-308 | .008 |
| 305-303 | .003 | 305-310 | .010 |
| 305-304 | .004 | 305-312 | .012 |
| 305-305 | .005 | 305-315 | .015 |
| 305-306 | .006 | | |

SIX INCH WIDTHS

100 Inch Strips

| Stock No. | Thickness | Stock No. | Thickness |
|-----------|-----------|-----------|-----------|
| 305-601 | .001 | 305-608 | .008 |
| 305-602 | .002 | 305-609 | .009 |
| 305-603 | .003 | 305-610 | .010 |
| 305-604 | .004 | 305-612 | .012 |
| 305-605 | .005 | 305-615 | .015 |
| 305-606 | .006 | 305-620 | .020 |
| 305-607 | .007 | 305-625 | .025 |

papco BRASS SHIM STOCK ASSORTMENTS ASSORTIMENTS FEUILLES POUR CALE LAITON

No. 020-850



papco
BRASS SHIM STOCK
Strip Assortment
020-850

This assortment consists of 5 strips of Brass Shim Stock 3" x 8" (120 sq. in.) in these thicknesses: .001, .002, .003, .005, .010.

Packed in individual envelope.

No. 020-863



This useful assortment consists of 5 strips of Brass Shim Stock 3" x 18" (270 square inches).

One strip each .001, .002, .003, .005, .010.

Each assortment is packed in a sturdy container.

305
Series

papco STEEL SHIM STOCK FEUILLES POUR CALE ACIER



"Papco" STEEL SHIM STOCK is hard shim temper and uniform in thickness. Supplied in Strips 100 inches long by 6 inches wide as listed. Each strip is packed in a sturdy fibre tube.

Six inches wide by 100 inches long.



| Stock No. | Thickness | Stock No. | Thickness |
|-----------|-----------|-----------|-----------|
| 306-601 | .001 | 306-604 | .004 |
| 306-602 | .002 | 306-605 | .005 |
| 306-603 | .003 | 306-606 | .006 |

| Stock No. | Thickness | Stock No. | Thickness |
|-----------|-----------|-----------|-----------|
| 306-607 | .007 | 306-612 | .012 |
| 306-608 | .008 | 306-615 | .015 |
| 306-610 | .010 | 306-620 | .020 |

Note: Stainless Steel Shim Stock available – price on application.

400
Series

papeco NYLON CABLE CLAMPS
COLLIERS DE CABLE NYLON

'Papco' 6/6 Black Nylon Cable Clamps are tough, resilient light-weight and highly resistant to wear, most chemicals such as gasoline, oil etc. and destructive U-V rays. Used to secure cables, pipes, tubing, wire etc. in automotive, marine, appliance, commercial and residential applications. All nylon clamps provide excellent insulation characteristics.



Order by Stock Number

| Stock No. | Cable Size | Clamp Width | Std. Pkg. | Stock No. | Cable Size | Clamp Width | Std. Pkg. |
|-----------|------------|-------------|-----------|-----------|------------|-------------|-----------|
| 400-522 | 1/4 | 3/8 | 50 | 400-528 | 5/8 | 1/2 | 25 |
| 400-524 | 3/8 | 3/8 | 50 | 400-530 | 3/4 | 1/2 | 25 |
| 400-526 | 1/2 | 3/8 | 50 | 400-532 | 1" | 1/2 | 15 |

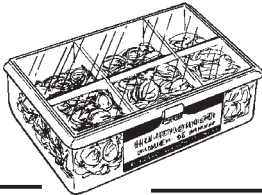

**NYLON CABLE CLAMP
GARAGE ASSORTMENT No. 020-088**

Contains 40 pieces - 6 sizes of Nylon Cable Clamps listed above. Packed in a sturdy, clear, plastic box.

400
Series

papeco STORAGE ORGANIZERS
CROCHETS D'ENTREPOSAGE

Rust resistant, vinyl coated screw hooks for organizing lawn and garden equipment, bicycles, hand tools, ladders, hoses, extension cords etc. Drill 3/16" hole, lubricate threads with beeswax or soap and screw in hook completely into surface.

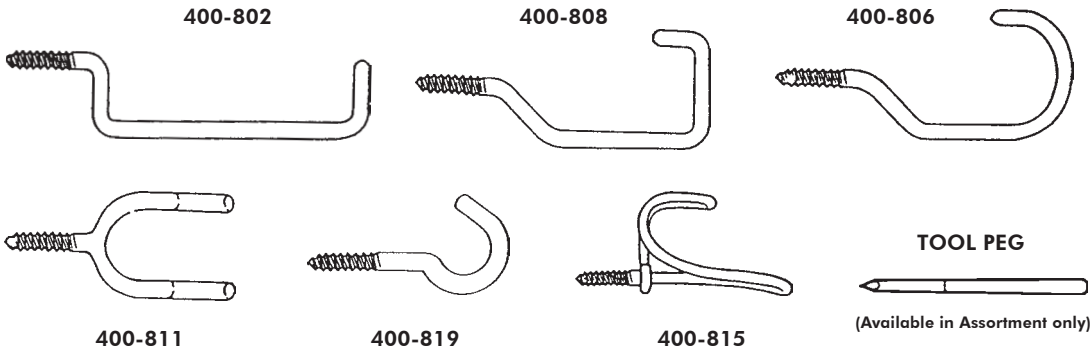

Order by Stock Number

Standard Package 10 Pieces

| Stock No. | Description | Over. Length | Stock No. | Description | Over. Length |
|-----------|--------------|--------------|-----------|---------------|--------------|
| 400-802 | LADDER HOOK | 7-1/2" | 400-811 | TOOL HOOK | 4" |
| 400-806 | BICYCLE HOOK | 6" | 400-815 | COAT/HAT HOOK | 3-1/2" |
| 400-808 | UTILITY HOOK | 6" | 400-819 | SCREW HOOK | 4" |

papeco STORAGE ORGANIZERS
KIT No. 400-820

Contains 17 pieces of Vinyl Coated Storage Hooks listed above - 7 sizes. 2pc. 400-802, 2pc. 400-806, 2pc. 400-808, 2pc. 400-811, 2pc. 400-815, 2pc. 400-819 and 5 Tool Pegs. Attractive, clamshell package with instructions and applications. Order by Kit Number.

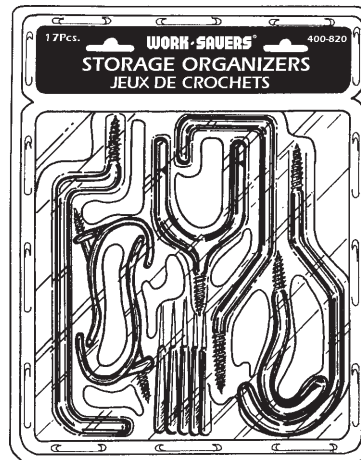



400 Series

Papco SNAP FASTENERS ATTACHES 'SNAP'

DURABLE FASTENERS

'Papco' Snap Fasteners provide superior snap action and holding strength. Snap Fasteners are self-piercing and made of heavy duty, nickel plated brass. Used in a variety of materials on boats, tents, sporting goods, RV's, luggage, awnings, clothing - camper, convertible and tonneau tops. Order by Stock Number

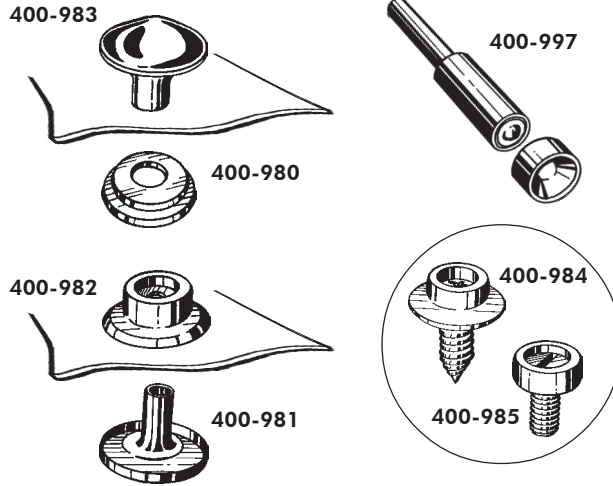

| Stock No. | Description | Std. Pkg. |
|-----------|----------------------------|-----------|
| 400-980 | 3/8 Socket - Normal Action | 25 |
| 400-981 | 3/8 Post - 10mm dia. | 25 |
| 400-982 | 3/8 Stud | 25 |
| 400-983 | 3/8 Cap 24mm dia. | 25 |
| 400-984 | 3/8 Screw Stud No. 8 | 25 |
| 400-985 | 3/8 Bolt Stud 10-32 | 25 |
| 400-997 | Installation Tool | 1 |

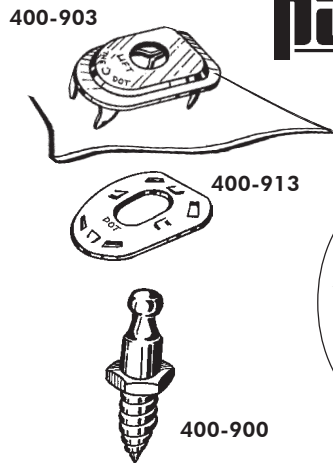

Papco LIFT-THE-DOT FASTENERS ATTACHES LIFT-THE DOT

Strong, heavy duty fasteners that lock on 3 sides. Opened by lifting the fourth side where the dot and trademark appear.

Order by Stock Number

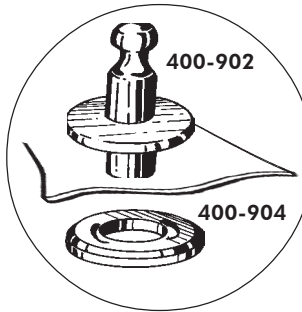

| Stock No. | Description | Std. Pkg. |
|-----------|-----------------------|-----------|
| 400-900 | No. 8 Wood Screw Stud | 25 |
| 400-902 | Stud | 25 |
| 400-903 | Socket | 25 |
| 400-904 | Washer | 25 |
| 400-913 | Back Plate | 25 |

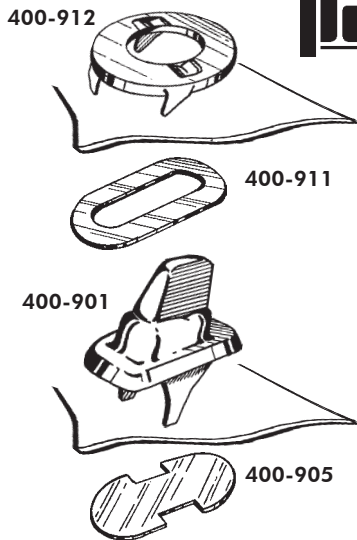

Papco TURN FASTENERS ATTACHES TOURANT

Also known as Common Sense Fasteners

'Papco' Turn Fasteners are positive locking and never open accidentally. Spring mechanism contained in stud holds fastener under tension until turned by hand.

Order by Stock Number

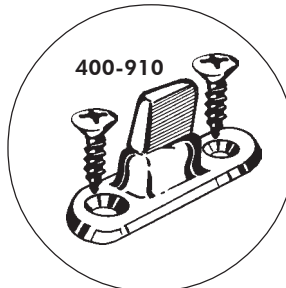

| Stock No. | Description | Std. Pkg. |
|-----------|-------------|-----------|
| 400-901 | Turn Button | 10 |
| 400-905 | Back Plate | 25 |
| 400-910 | Turn Button | 10 |
| 400-911 | Washer | 25 |
| 400-912 | Grommet | 25 |

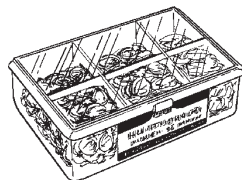

GARAGE ASSORTMENT No. 020-091

Contains 25 pieces including installation tool of the most popular Snap Fasteners packed in a sturdy, transparent box.

GARAGE ASSORTMENT No. 020-092

Contains 20 pieces of Lift-the-Dot® Fasteners in a clear, compartmentized plastic box.

GARAGE ASSORTMENT No. 020-093

Contains 20 pieces of 'Papco' Turn Fasteners packed in a clear, plastic container with hinged lid.

400
Series

papco

**BRASS GROMMETS
BAGUES EN LATION**



Solid brass, tooth type grommets are recommended for extra holding power and corrosion resistance. Use grommets on tents, tarpaulins, trucks, sails, awnings, boat covers, pool covers, lawn furniture etc. Available in two sizes: No. 400-958 3/8" I.D. and No. 400-960 1/2" I.D.



Order by Stock Number

Standard Package 10 Pieces per Bag

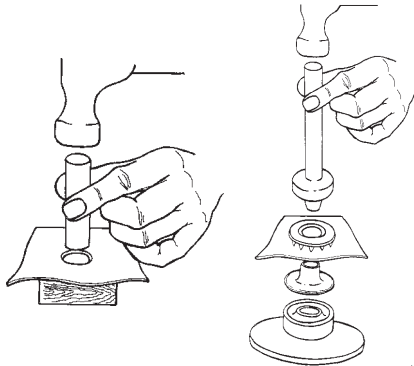

No. 400-968

3/8" GROMMET KIT

Consists of hole punch, flaring punch and anvil base. Includes 10 solid brass 3/8" grommets with tooth type washers. Packed with instructions in a re-usable hang-up vinyl pouch. Professional quality tool kit.

No. 400-970

1/2" GROMMET KIT

Professional setting tool and ten 1/2" grommets as above.

400
Series

papco

**MAGNETIC RETRIEVER
RAMASSE-PIECES AIMANTE**

No. 400-024



This chrome plated, telescopic tool has a powerful, permanent NEODYMIUM magnetic tip that will lift over 3.5 pounds. The retriever can be used to pick-up steel objects, dropped tools, fasteners etc. from hard-to-reach places. Six inches long with a handy pocket clip, extends to over 24". Can also be used as a presentation pointer.

Order by Stock Number

Individually Carded

papco **HEAVY-DUTY LIFTING MAGNET**
AIMANT RECUPERATEUR
USAGE INTENSE

No. 400-020

For commercial, recreational or household use. Ideal for removing dents in metal. Retrieve submerged tools, metal parts, tackle, fishing poles etc. Locate, lift, hold or hang steel articles.

Lifts up to 150 lbs.

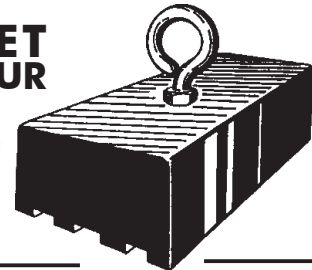

Order by Stock Number

Individually Packaged

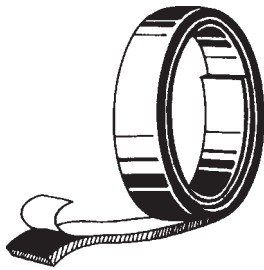

papco **MAGNETIC STRIP**
BANDE MAGNETIQUE

No. 400-010

Flexible, Magnetic Strip with adhesive back, cuts easily with scissors or a knife. Magnetic surface of strip holds small metal objects. Ideal for Body Shops for holding plastic masking material or work orders to vehicle body areas without damaging painted surfaces. Perfect for mounting signs. Size: 1/2" wide x 10 feet long.

Order by Stock Number

Individually Packaged

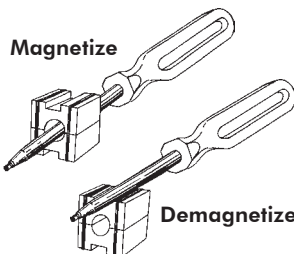

papco **TOOL MAGNETIZER/
DEMAGNETIZER**

No. 400-022

Easy-to-use tool magnetizes screwdrivers, wrenches and other small tools. Pass tool through centre hole of charger to magnetize. To demagnetize pass tool over outside edge of charger several times.

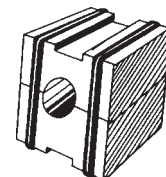

Order by Stock Number Individually Packaged

For Ceramic Block Magnets No. 400-002 see page 81.



558
Series

559
Series

papeco WHEEL NUTS
ECROUS DE ROUE

Passenger Car/Light Truck

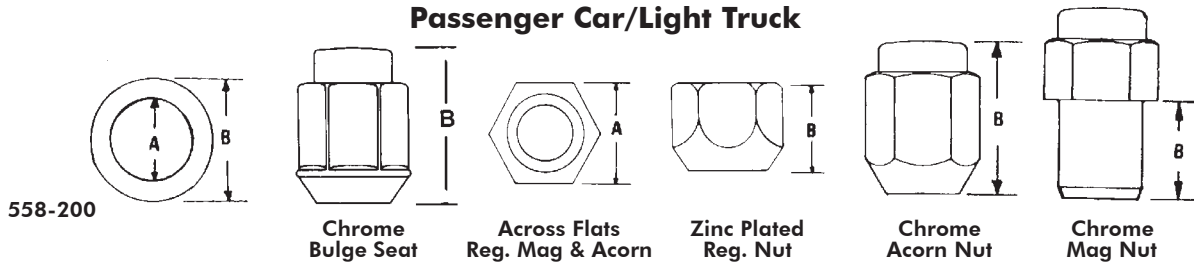

| Part No. | Diameter/Type | 'A' | 'B' | St. Pkg. | Part No. | Diameter/Type | 'A' | 'B' | St. Pkg. |
|----------|--------------------|--------|--------|----------|----------|---------------------|-------|-------|----------|
| 558-014 | 7/16-20R Reg. | 3/4 | 9/16 | 25 | 558-146 | 1/2-20 Acorn | 13/16 | 1-3/8 | 10 |
| 558-015 | 7/16-20L Reg. | 3/4 | 9/16 | 25 | 558-148 | 1/2-20R Acorn Bulge | 3/4 | 1-3/8 | 10 |
| 558-016 | 1/2-20R Reg. | 13/16 | 5/8 | 25 | 558-174 | 7/16-20 Mag | 13/16 | 3/4 | 10 |
| 558-026 | 1/2-20L Reg. | 3/4 | 9/16 | 25 | 558-176 | 1/2-20 Mag | 13/16 | 3/4 | 10 |
| 558-027 | 1/2-20R Reg. | 3/4 | 9/16 | 25 | 558-200 | Mag Washers | 11/16 | 1 | 10 |
| 558-031 | 1/2-20L Reg. | 13/16 | 5/8 | 25 | 559-060 | M10x1.25 Acorn | 17mm | 21mm | 10 |
| 558-044 | 5/8-18R Reg. | 1-1/16 | 21/32 | 10 | 559-064 | M12x1.25 Reg | 19mm | 16mm | 10 |
| 558-045 | 5/8-18L Reg. | 1-1/16 | 21/32 | 10 | 559-065 | M12x1.25 Acorn | 13/16 | 1-3/8 | 10 |
| 558-047 | 9/16-18R Reg. | 1 | 11/16 | 10 | 559-070 | M12x1.5 Acorn | 13/16 | 1-3/8 | 10 |
| 558-050 | 9/16-18L Reg. | 1 | 11/16 | 10 | 559-075 | M12x1.5 Acorn | 3/4 | 1-3/8 | 10 |
| 558-055 | 5/8-18R Reg. | 1 | 21/32 | 10 | 559-077 | M12x1.5 Acorn Bulge | 19mm | 35mm | 10 |
| 558-057 | 5/8-18R Flange | 1-1/8 | 1-1/16 | 10 | 559-095 | M12x1.25 Mag | 13/16 | 3/4 | 10 |
| 558-058 | 9/16-18R Reg. | 1-1/16 | 21/32 | 10 | 559-100 | M12x1.5 Mag | 13/16 | 3/4 | 10 |
| 558-061 | 9/16-18R Reg. | 1-1/16 | 15/16 | 10 | 559-125 | M12x1.25 Reg | 21mm | 16mm | 10 |
| 558-061 | 9/16-18R Wash. Nut | 1-1/16 | 1 | 10 | 559-150 | M12x1.5 Reg | 19mm | 16mm | 10 |
| 558-100 | 9/16-18R Reg. | 7/8 | 3/4 | 10 | 559-154 | M14x1.5 Reg | 22mm | 21mm | 10 |
| 558-140 | 7/16-20 Acorn | 3/4 | 1-3/8 | 10 | 559-163 | M12x1.5 Reg | 19mm | 23mm | 10 |
| 558-144 | 7/16-20 Acorn | 13/16 | 1-3/8 | 10 | 559-172 | M12x1.5 Reg | 21mm | 16mm | 10 |

560
Series

papeco WHEEL BOLTS
BOULONS DE ROUE

Passenger Car/Light Truck

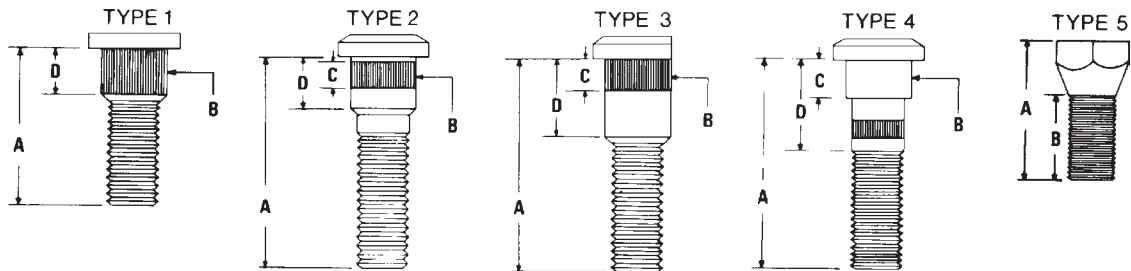

Bare Metal/Métal Nu

Standard Package/Contenant Régulier 10 pcs.

| Part No. | Type | Diameter x 'A' | 'B' | 'C' | 'D' | Factory No. |
|----------|------|--------------------|------|---------|-------|-------------|
| 560-018 | 5 | 1/2-20 R x 1-7/16 | 7/8 | 3/4 HEX | - | |
| 560-019 | 5 | 9/16-18 R x 1-7/16 | 7/8 | 3/4 HEX | - | |
| 560-032 | 1 | 1/2-20 R x 1-3/8 | .630 | - | .555 | 2405146 |
| 560-033 | 1 | 1/2-20 L x 1-3/8 | .630 | - | .555 | 2405147 |
| 560-034 | 1 | 1/2-20 R x 1-1/2 | .618 | - | .312 | 1486230 |
| 560-039 | 1 | 1/2-20 R x 1-5/8 | .620 | - | .688 | 2952858 |
| 560-040 | 1 | 1/2-20 L x 1-5/8 | .620 | - | .688 | 2952859 |
| 560-041 | 1 | 7/16-20 R x 1-3/8 | .560 | - | .312 | 3829376 |
| 560-090 | 2 | 1/2-20 R x 1-5/16 | .625 | .250 | .438 | 539499 |
| 560-095 | | USE 560-032 | | | | 399866 |
| 560-096 | 1 | 7/16-20 R x 1-7/16 | .560 | - | .530 | 2534754 |
| 560-098 | 2 | 7/16-20 R x 1-3/8 | .480 | .220 | .375 | 1235136 |
| 560-102 | 2 | 1/2-20 R x 1-5/8 | .562 | .250 | .563 | 3229187 |
| 560-103 | 2 | 1/2-20 R x 1-1/2 | .665 | .300 | .540 | 2513744 |
| 560-104 | 2 | 1/2-20 L x 1-1/2 | .665 | .300 | .540 | 2513745 |
| 560-105 | 2 | 1/2-20 R x 1-13/16 | .560 | .300 | .750 | 3699680 |
| 560-109 | | USE 560-034 | | | | |
| 560-110 | 4 | 1/2-20 R x 2 | .623 | .320 | 1.000 | 3736751 |
| 560-114 | 2 | 7/16-20 R x 1-1/2 | .465 | .140 | .285 | 9590259/71 |

560
Series

Papco® **WHEEL BOLTS**
BOULONS DE ROUE



Passenger Car/Light Truck
Specifications and/et Interchange.

| Bare Metal/Métal Nu | | Standard Package/Contenant Régulier 10 pcs. | | | | |
|---------------------|------|---|------|------|-------|-------------|
| Part No. | Type | Diameter x `A` | `B` | `C` | `D` | Factory No. |
| 560-134 | | USE 560-148 | | | | |
| 560-138 | 2 | 1/2-20 R x 1-5/8 | .535 | .250 | .325 | 1235137 |
| 560-148 | 2 | 1/2-20 R x 1-13/16 | .620 | .220 | .780 | 3580693 |
| 560-153 | | USE 560-034 | | | | |
| 560-154 | | USE 560-148 | | | | |
| 560-155 | 1 | 1/2-20 R x 1-5/8 | .630 | - | .620 | 3961258 |
| 560-160 | | USE 560-110 | | | | |
| 560-161 | | USE 560-110 | | | | |
| 560-163 | 2 | 1/2-20 R x 1-7/16 | .545 | .250 | .438 | D3AZ-1107B |
| 560-165 | | USE 560-172 | | | | |
| 560-167 | 2 | 1/2-20 R x 1-15/16 | .587 | .220 | .625 | D6AZ-1107C |
| 560-172 | 2 | 1/2-20 R x 1-7/8 | .560 | .210 | .375 | D6DZ-1107A |
| 560-173 | 2 | 1/2-20 R x 1-3/4 | .625 | .250 | .438 | D6AZ-1107A |
| 560-175 | 2 | 1/2-20 R x 1-3/4 | .665 | .312 | .530 | 2959852 |
| 560-177 | | USE 560-148 | | | | |
| 560-178 | | USE 560-110 | | | | |
| 560-179 | 4 | 5/8-18 R x 2-3/8 | .720 | .200 | 1.200 | 3641662 |
| 560-180 | 4 | 5/8-18 R x 2-1/16 | .655 | .312 | .906 | 3496564 |
| 560-181 | 2 | 5/8-18 R x 2-7/16 | .650 | .255 | .813 | 3641576 |
| 560-182 | 4 | 5/8-18 R x 2-9/16 | .655 | .312 | .906 | 2515316 |
| 560-183 | 4 | 5/8-18 R x 2-15/16 | .650 | .335 | 1.000 | 3637878 |
| 560-184 | 4 | 5/8-18 R x 2-1/4 | .650 | .333 | .844 | 2515310 |
| 560-185 | | USE 560-110 | | | | |
| 560-186 | 2 | 1/2-20 R x 1-7/8 | .612 | .250 | .600 | E0TZ-1107C |
| 560-187 | 4 | 1/2-20 R x 1-5/8 | .623 | .375 | .750 | 5357196 |
| 560-268 | | USE 560-148 | | | | |
| 560-269 | 2 | 1/2-20 R x 2-1/8 | .623 | .200 | .625 | D3TZ-1107AE |
| 560-286 | 2 | 1/2-20 R x 2-3/16 | .723 | - | 1.187 | 4116934 |
| 560-287 | 2 | 1/2-20 R x 1-29/32 | .667 | - | .781 | 6032505 |
| 560-289 | 2 | 1/2-20 R x 1-29/32 | .583 | - | .625 | 6033382 |
| 560-298 | 2 | 1/2-20 R x 2 | .547 | - | .687 | E6TZ-1107B |
| 560-303 | 2 | 9/16-18 R x 3-9/32 | .677 | - | .937 | E5TZ-1107B |
| 560-305 | 2 | 9/16-18 R x 2-1/8 | .640 | - | .562 | E6TZ-1107A |
| 560-315 | 2 | 1/2-20 R x 1-9/16 | .558 | .155 | .333 | E5TZ-1107A |
| 560-348 | 4 | 1/2-20 R x 2-1/8 | .658 | - | .812 | 4383430 |
| 560-355 | 4 | 9/16-18 R x 2-13/16 | .630 | .200 | 1.125 | D0TZ-1107A |
| 560-356 | 4 | 9/16-18 L x 2-13/16 | .630 | .200 | 1.125 | D0TZ-1119A |
| 560-358 | 2 | 1/2-20 R x 2 | .612 | - | .656 | E9ZZ-1107A |
| 560-363 | 2 | 1/2-20 R x 2-11/32 | .651 | - | .937 | 4030779 |
| 560-364 | 2 | 1/2-20 R x 1-15/32 | .618 | - | .484 | 83503053 |
| 560-366 | 2 | 1/2-20 R x 1-3/4 | .650 | .370 | .740 | 1229808-9 |
| 560-367 | 2 | 1/2-20 R x 2 | .585 | - | .750 | F1VY-1107A |
| 560-368 | 2 | 1/2-20 R x 1-31/32 | .615 | - | .531 | F0VY-1107A |
| 560-376 | 2 | 9/16-18 R x 1-7/8 | .620 | .230 | .750 | 3997956 |
| 560-386 | 2 | 7/16-20 R x 1-5/16 | .555 | .320 | .375 | 9590258 |
| 560-390 | 2 | 7/16-20 R x 1-1/2 | .555 | .300 | .690 | 9785156 |
| 560-424 | | USE 560-110 | | | | |
| 560-441 | 4 | 1/2-20 L x 1-15/16 | .625 | .378 | 1.030 | 2925171 |
| 560-458 | 4 | 9/16-18 R x 2-5/32 | .630 | .325 | .950 | C9TZ-1107C |
| 560-459 | 2 | 9/16-18 R x 2-1/8 | .623 | .325 | .500 | 334388 |
| 560-460 | 2 | 9/16-18 R x 3 | .630 | .875 | 1.062 | 3988538 |
| 560-461 | 2 | 9/16-18 R x 3-9/16 | .630 | .875 | 1.325 | 355815 |
| 560-468 | 4 | 9/16-18 R x 2-1/8 | .650 | .250 | .875 | 475988 |
| 560-469 | 4 | 9/16-18 R x 2-1/2 | .650 | .375 | .875 | 14002236 |
| 560-470 | 4 | 1/2-20 R x 1-3/4 | .625 | .200 | .740 | 2955940 |
| 560-471 | 4 | 1/2-20 L x 1-3/4 | .625 | .200 | .740 | 2955941 |
| 560-472 | 2 | 9/16-18 R x 2 | .623 | .250 | .625 | C8TZ-1170E |
| 560-473 | 4 | 9/16-18 R x 2-5/8 | .622 | .200 | .813 | E0TZ-1107B |
| 560-474 | 2 | 9/16-18 R x 2-1/2 | .620 | .240 | .740 | E4TZ-1107A |
| 560-604 | 4 | 7/16-20 R x 1-3/4 | .575 | .280 | .860 | 3995841 |



For Heavy Truck Wheel Nuts, Bolts and Studs; Rim Bolts and Nuts plus Rear Wheel Studs see current Wheel Parts catalogue.

For Applications of `Papco` Wheel Parts see current catalogue/application guide.



561
Series

papco

METRIC WHEEL BOLTS
BOULONS DE ROUE METRIQUE

Passenger Car/Light Truck

Specifications and/et Interchange.

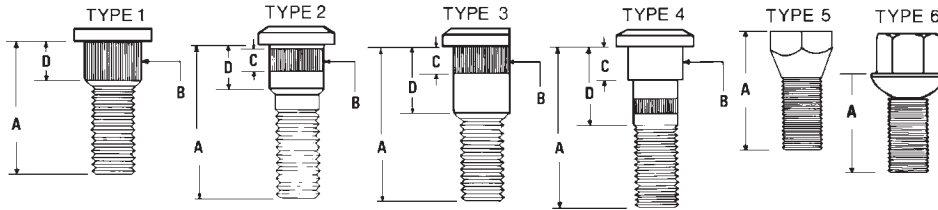

Bare Metal/Métal Nu

Standard Package/Contenant Régulier 10 pcs.

| Part No. | Type | Diameter x 'A' | 'B' | 'C' | 'D' | Factory No. |
|----------|------|---------------------|----------|-------|---------|---------------------|
| 561-100 | 2 | M12 x 1.25R x 39mm | 12.9mm | 7mm | 15.4mm | 40222-A0800 |
| 561-102 | 2 | M12 x 1.25R x 32mm | 12.9mm | 7mm | 11.6mm | 40222-2201 |
| 561-106 | 1 | M12 x 1.5R x 38.5mm | 14.7mm | 5.5mm | - | 6500352/073 |
| 561-108 | 1 | M12 x 1.5R x 38.5mm | 14.3mm | 9.5mm | - | 5204272 |
| 561-109 | 3 | M12 x 1.5R x 40mm | 14.8mm | 7mm | 13mm | - |
| 561-110 | 2 | M12 x 1.5R x 43mm | 13mm | 6mm | 8mm | 9590475/76 |
| 561-111 | 2 | M12 x 1.5R x 39mm | 13mm | 6mm | 8mm | - |
| 561-112 | 2 | M12 x 1.5R x 40mm | 12.5mm | 7.5mm | 11.3mm | 94024217 |
| 561-114 | 1 | M12 x 1.5R x 38mm | 14.35mm | 7mm | - | 94025172 |
| 561-118 | 5 | M12 x 1.5R x 34mm | 19mm Hex | - | - | 3238138, D8RZ-1107B |
| 561-120 | 2 | M12 x 1.5R x 45mm | 14.3mm | 9mm | 13mm | 90942-02034 |
| 561-122 | 2 | M12 x 1.5R x 36mm | 14.3mm | 6mm | 16mm | 90942-02035 |
| 561-126 | 2 | M12 x 1.5R x 41mm | 14.2mm | 5mm | 12mm | 90942-02037 |
| 561-128 | 2 | M12 x 1.5R x 38mm | 14.2mm | 7.5mm | 13mm | 90942-02014 |
| 561-129 | 2 | M12 x 1.5R x 42mm | 13mm | 7mm | 12mm | MH349894 |
| 561-130 | 6 | M12 x 1.5R x 27mm | 17mm Hex | - | - | 321-601-139 |
| 561-132 | 6 | M12 x 1.5R x 30mm | 17mm Hex | - | - | 321-601-139C |
| 561-133 | 6 | M14 x 1.5R x 31mm | 17mm Hex | - | - | 431/443-601-139A |
| 561-138 | | USE 561-129 | | | | |
| 561-139 | 2 | M12 x 1.5R x 37mm | 14mm | 4mm | 11mm | - |
| 561-140 | 1 | M12 x 1.5R x 37mm | 14.4mm | 6.4mm | - | MB057603 |
| 561-152 | 6 | M12 x 1.5R x 39mm | 19mm Hex | - | - | 90304-692-920-921 |
| 561-154 | 1 | M12 x 1.5R x 36mm | 12mm | 10mm | - | 90113-SAO-003 |
| 561-155 | 1 | M12 x 1.25R x 33mm | 12mm | 8mm | - | 90113-634-003 |
| 561-158 | 2 | USE 561-112 | | | | |
| 561-166 | 1 | M12 x 1.5R x 32mm | 13mm | 9mm | - | D5RY-1107C |
| 561-167 | 6 | M12 x 1.5R x 28mm | 19mm Hex | - | - | - |
| 561-168 | 2 | M12 x 1.5R x 38mm | 13mm | 7mm | 12mm | E07Z-1107A/C |
| 561-169 | 2 | M12 x 1.5R x 43mm | 12.85mm | 7.5mm | 12.7mm | F0CZ-1107A |
| 561-170 | 1 | M12 x 1.5R x 30mm | 14.5mm | 8mm | - | - |
| 561-174 | 2 | M12 x 1.25R x 34mm | 12.24mm | 10mm | 13mm | 96057612 |
| 561-175 | 2 | M12 x 1.25R x 38mm | 12.24mm | 10mm | 14mm | 96057613 |
| 561-212 | 2 | M12 x 1.5R x 44mm | 14.5mm | 5mm | 10mm | - |
| 561-247 | 2 | M12 x 1.5R x 46mm | 13.41mm | 6.5mm | 11.2mm | F0DZ-1107A |
| 561-248 | 3 | M12 x 1.5R x 43mm | 14.5mm | 6mm | 11mm | E43Z-1107A |
| 561-249 | 2 | M12 x 1.5R x 46mm | 15.37mm | 7mm | 15mm | E9SZ-1107C |
| 561-250 | 3 | M12 x 1.5R x 47mm | 13.34mm | 6.5mm | 14.3mm | E9SZ-1107A |
| 561-251 | 2 | M12 x 1.5R x 51mm | 13.5mm | 5mm | 18mm | E3FZ-1107A |
| 561-255 | 2 | M12 x 1.5R x 52mm | 12.9mm | 13mm | 25.4mm | FB05-26-113A |
| 561-264 | 2 | M12 x 1.5R x 52mm | 14.33mm | - | 25.12mm | 90942-02053/044 |
| 561-309 | 2 | M12 x 1.5R x 42mm | 13.08mm | - | 18.03mm | 8596-33-062 |
| 561-312 | 2 | M12 x 1.5R x 44mm | 14.17mm | - | 12.70mm | MB584750 |
| 561-322 | 2 | M12 x 1.25R x 30mm | 14.27mm | - | 6.10mm | - |
| 561-361 | 2 | M12 x 1.5R x 41mm | 16.50mm | - | 12.60mm | 6501268, 6501512 |
| 561-369 | 2 | M12 x 1.5R x 46mm | 15.00mm | - | 18.00mm | 6502311 |
| 561-370 | 2 | M12 x 1.5R x 44mm | 15.80mm | - | 16.40mm | 6502247 |
| 561-371 | 2 | M12 x 1.5R x 43mm | 17.00mm | - | 15.00mm | 6502330 |
| 561-376 | 2 | M12 x 1.5R x 49mm | 13.90mm | - | 15.00mm | F3DZ-1107A |
| 561-380 | 1 | M10 x 1.5R x 29mm | 10mm | 9mm | - | 96055156 |
| 561-410 | 2 | M14 x 1.5R x 49mm | 15.7mm | 9mm | 14mm | 12338057 |
| 561-411 | 2 | M14 x 1.5R x 76mm | 15.7mm | 23mm | 27mm | 15545356 |
| 561-413 | 2 | M14 x 1.5R x 43mm | 15.7mm | 4mm | 6mm | 12338040 |
| 561-414 | 2 | M14 x 1.5R x 43mm | 15.7mm | 8mm | 14mm | 15589423 |
| 561-415 | 2 | M14 x 1.5R x 46mm | 15.8mm | 7mm | 14mm | 15589455 |
| 561-417 | 4 | M14 x 1.5R x 54mm | 15.7mm | 7mm | 19mm | 15589486 |
| 561-418 | 2 | M14 x 1.5R x 91mm | 15.7mm | 22mm | 33mm | 15589493 |

For Applications of 'Papco' Wheel Parts see current catalogue/application guide.

562
Series



CARDED WHEEL NUTS
ECROUS DE ROUE SUR CARTE

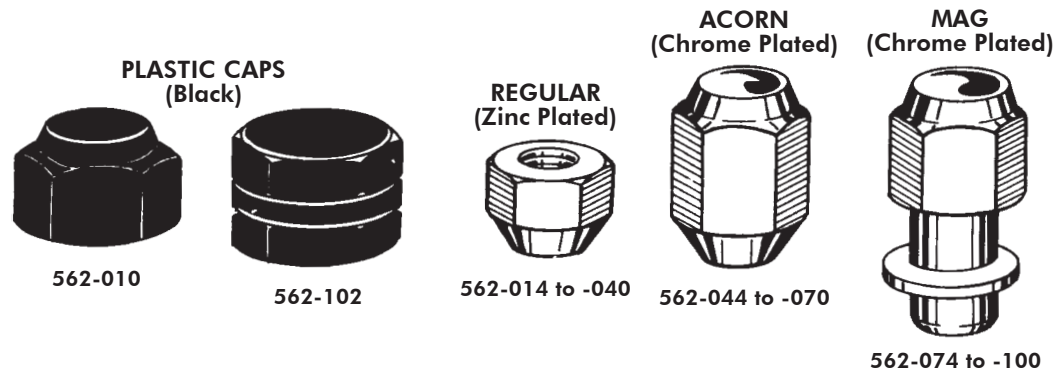

Inch Nuts and Caps packed 5 pcs. per card
Metric Nuts packed 4 pcs. per card

Order by Stock Number

| Card No. | Cat. No. | Size | Type | Application | Card No. | Cat. No. | Size | Type | Application |
|-----------|-----------|----------------------|-------|----------------|----------|-----------|-------------|-------|-------------------|
| 562-010 | | Fits 13/16 Ford Nuts | Cap | Ford | 562-063 | (559-163) | M12 x 1.5R | Reg. | Chrysler, Imports |
| 562-012 | | Fits 3/4 Chrys. Nuts | Cap | Chrysler, GMC | 562-064 | (559-064) | M12 x 1.25R | Reg. | Imports |
| 562-014 | (558-014) | 7/16-20R | Reg. | Chrysler, GMC | 562-065 | (559-065) | M12 x 1.25R | Acorn | Datsun |
| 562-016 | (558-016) | 1/2-20R | Reg. | AMC, Ford, GMC | 562-070 | (559-070) | M12 x 1.5R | Acorn | All |
| 562-027 | (558-027) | 1/2-20R | Reg. | Chrysler | 562-072 | (559-172) | M12 x 1.5R | Reg. | Ford, Imports |
| 562-035 | (559-125) | M12 x 1.25R | Reg. | Datsun | 562-074 | (558-174) | 7/16-20R | Mag | Chrysler, GMC |
| 562-040 | (559-150) | M12 x 1.5R | Reg. | All | 562-076 | (558-176) | 1/2-20R | Acorn | AMC, Ford, GMC |
| 562-044* | (558-144) | 7/16-20R | Acorn | Chrysler, GMC | 562-077 | (559-077) | M12x1.5R | Mag | Imports |
| 562-045** | (558-140) | 7/16-20R | Acorn | GMC | 562-095 | (559-095) | M12 x 1.25R | Mag | Datsun |
| 562-046 | (558-146) | 1/2-20R | Acorn | AMC, Ford, GMC | 562-100 | (559-100) | M12 x 1.5R | Mag | All |
| 562-048 | (558-148) | 1/2-20R | Acorn | AMC, Ford, GMC | 562-154 | (559-154) | M14 x 1.5R | Reg. | GM |
| 562-060 | (559-060) | M10 x 1.25R | Acorn | Geo, GMC | | | | | |

*13/16 AF Nuts; **3/4 AF Nuts

Papco **CARDED WHEEL PARTS KITS**
TROUSSE DE PIECES DE ROUE SUR CARTE

'Papco' Wheel Parts Kits provide 95% coverage of today's car and truck applications. Each Kit includes one Wheel Bolt and Nut skin-packed on an attractive, three colour, point-of purchase display card. Each card features easy to follow installation instructions, application and illustration - plus a price code system for faster check-out service.

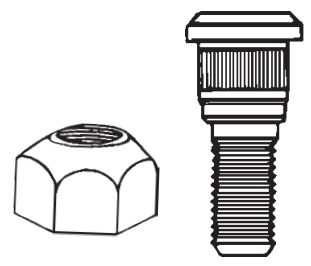

| Card No. | Cat. No. | Size | Application | Card No. | Cat. No. | Size | Application |
|-----------|-----------|---------------------|--------------------------|----------|-----------|---------------------|-----------------------|
| 562-018 | (560-018) | 1/2-20R x 1-7/16 | Trailer Bolt (2/card) | 562-273 | (560-173) | 1/2-20R x 1-3/4 | Ford & Truck |
| 562-019 | (560-019) | 9/16-18R x 1-7/16 | Trailer Bolt (2/card) | 562-274 | (561-174) | M12 x 1.25R x 34mm | Geo, Suzuki Truck |
| 562-114 | (560-114) | 7/16-20R x 1-1/2 | GMC & Truck, Jeep | 562-302 | (561-102) | M12 x 1.25R x 39mm | Datsun/ Nissan |
| 562-126 | (560-386) | 7/16-20R x 1-5/16 | GMC & Truck | 562-306 | (561-106) | M12 x 1.5R x 38.5mm | Chrysler, Renault |
| 562-138 | (560-138) | 1/2-20R x 1-5/8 | GMC & Truck | 562-308 | (561-108) | M12 x 1.5R x 38.5mm | GMC, Chrysler, Dodge |
| 562-155* | (560-155) | 1/2-20R x 1-5/8 | GMC & Truck | 562-309 | (561-109) | M12 x 1.5R x 40mm | Chrysler, Dodge Truck |
| 562-156** | (560-155) | 1/2-20R x 1-5/8 | Chrysler | 562-310 | (561-110) | M12 x 1.5R x 43mm | GMC & Truck |
| 562-171 | (560-034) | 1/2-20R x 1-1/2 | GMC, Ford, International | 562-311 | (561-111) | M12 x 1.5R x 39mm | GMC & Truck |
| 562-172 | (560-102) | 1/2-20R x 1-5/8 | AMC, Dodge Truck, Ford | 562-312 | (561-212) | M12 x 1.5R x 44mm | Ford |
| 562-173 | (560-103) | 1/2-20R x 1-1/2 | Chrysler, Dodge Truck | 562-322 | (561-122) | M12 x 1.5R x 36mm | GMC, Toyota |
| 562-175 | (560-105) | 1/2-20R x 1-13/16 | AMC, Chrysler, Dodge | 562-329 | (561-129) | M12 x 1.5R x 42mm | Chrysler, Imports |
| 562-200 | (561-100) | M12 x 1.25R x 39mm | Nissan Truck | 562-339 | (561-139) | M12 x 1.5R x 37mm | GMC |
| 562-201 | (561-100) | M12 x 1.25R x 39mm | Nissan | 562-348 | (561-248) | M12 x 1.5R x 43mm | Ford |
| 562-204 | (560-604) | 7/16-20R x 1-3/4 | GMC Truck, Jeep | 562-351 | (561-251) | M12 x 1.5R x 51mm | Ford |
| 562-206 | (561-106) | M12 x 1.5R x 38.5mm | Dodge, Chrysler | 562-354 | (561-154) | M12 x 1.5R x 36mm | Honda |
| 562-208 | (561-108) | M12 x 1.5R x 38.5mm | Dodge, Chrysler Truck | 562-366 | (561-169) | M12 x 1.5R x 43mm | Ford, Mazda |
| 562-209 | (561-109) | M12 x 1.5R x 40mm | Chrysler | 562-367 | (560-367) | 1/2-20R x 2 | Ford, Mercury |
| 562-210** | (560-110) | 1/2-20R x 2 | Chrysler, Dodge Truck | 562-368 | (561-168) | M12 x 1.5R x 38mm | Ford, Mazda |
| 562-211 | (560-110) | 1/2-20R x 2 | Ford | 562-369 | (560-269) | 1/2-20R x 2-1/8 | Ford Truck |
| 562-215 | (560-315) | 1/2-20R x 1-9/16 | Ford Truck | 562-386 | (560-186) | 1/2-20R x 1-7/8 | Ford Truck |
| 562-220 | (561-120) | M12 x 1.5R x 45mm | Toyota Truck | 562-409 | (561-309) | M12 x 1.5 x 42mm | Mazda Truck |
| 562-226 | (561-126) | M12 x 1.5R x 41mm | Geo, Toyota Truck | 562-415 | (560-315) | 1/2-20R x 1-9/16 | Ford Truck |
| 562-240 | (561-140) | M12 x 1.5R x 37mm | Chrysler Imports | 562-422 | (561-322) | M12 x 1.25 x 30mm | Subaru |
| 562-248 | (560-148) | 1/2-20R x 1-13/16 | AMC, Ford, GMC, Intern. | 562-461 | (561-361) | M12 x 1.5 x 41mm | Chrysler |
| 562-267 | (560-167) | 1/2-20R x 1-15/16 | Ford | 562-476 | (561-376) | M12 x 1.5 x 49mm | Ford, Mercury |
| 562-272 | (560-172) | 1/2-20R x 1-7/8 | Ford & Truck | 562-480 | (561-380) | M12 x 1.25 x 29mm | GM, Geo |

*13/16 AF Nuts; **3/4 AF Nuts



papco® WHEEL PARTS MERCHANDISERS

ASSORTIMENTS DE PIÈCES DE ROUE SUR CARTE

'Papco' Wheel Parts are merchandised on three easy to stock, space-saving display racks designed for countertop, pegboard wall, gondola or pylon displays. Modular, metal display rack measures 16" x 24" and features a bilingual, reversible header sign, 20 safety hooks, inventory control system and a planogram for product layout. Merchandisers No. 022-144 and 145 include a 40 card starter stock and merchandiser No. 022-146 includes a 20 card starter stock. Bonus cards are included with each merchandiser to offset the cost of the rack.

- 95% vehicle coverage
- Modular self-serve displays
- Inventory control system
- Applications on each card



GM and IMPORTS WHEEL PARTS MERCHANDISER No. 022-144

| Card No. | Cat. No. | Description | Card No. | Cat. No. | Description |
|----------|-----------|-------------------------|----------|-----------|-------------|
| 562-018 | (560-018) | Trailer Bolts (2/card) | 562-226 | (561-126) | Geo, Toyota |
| 562-019 | (560-019) | Trailer Bolts (2/card) | 562-274 | (561-174) | Geo, Suzuki |
| 562-114 | (560-114) | GM & Truck, Jeep | 562-308 | (561-108) | GM |
| 562-126 | (560-386) | GM & Truck | 562-310 | (561-110) | GM & Truck |
| 562-138 | (560-138) | GM & Truck | 562-311 | (561-111) | GM & Truck |
| 562-155 | (560-155) | GM & Truck | 562-322 | (561-122) | Toyota |
| 562-200 | (561-100) | Datsun / Nissan & Truck | 562-339 | (561-139) | GM |
| 562-201 | (561-100) | Datsun / Nissan & Truck | 562-354 | (561-154) | Honda |
| 562-204 | (560-604) | GM & Truck Jeep | 562-422 | (561-322) | Subaru |
| 562-220 | (561-120) | Toyota | 562-480 | (561-380) | Geo, GM |

CHRYSLER and FORD WHEEL PARTS MERCHANDISER No. 022-145

| Card No. | Cat. No. | Description | Card No. | Cat. No. | Description |
|----------|-----------|-------------------------|----------|-----------|--------------|
| 562-173 | (560-103) | Chrysler, Dodge & Truck | 562-351 | (561-251) | Ford |
| 562-206 | (561-106) | Chrysler, Dodge | 562-366 | (561-169) | Ford |
| 562-208 | (561-108) | Chrysler, Dodge & Truck | 562-367 | (560-367) | Ford |
| 562-209 | (561-109) | Chrysler, Dodge & Truck | 562-368 | (561-168) | Ford |
| 562-240 | (561-140) | Chrysler Imports | 562-369 | (560-269) | Ford & Truck |
| 562-272 | (560-172) | Ford & Truck | 562-386 | (560-186) | Ford & Truck |
| 562-273 | (560-173) | Ford & Truck | 562-409 | (561-309) | Mazda |
| 562-312 | (561-212) | Ford | 562-415 | (560-315) | Ford & Truck |
| 562-329 | (561-129) | Chrysler Imports | 562-461 | (561-361) | Chrysler |
| 562-348 | (561-248) | Ford | 562-476 | (561-376) | Ford |

WHEEL NUTS MERCHANDISER No. 022-146

| Card No. | Cat. No. | Description | Type | Card No. | Cat. No. | Description | Type |
|----------|-----------|-----------------------|-------|----------|-----------|-----------------------------|-------|
| 562-010 | | For 13/16AF Nuts | Caps | 562-063 | (559-163) | M12 x 1.5R Chrysler Imports | Reg. |
| 562-012 | | For 3/4AF Nuts | Caps | 562-064 | (559-064) | M12 x 1.25R Imports | Reg. |
| 562-014 | (558-014) | 7/16-20R Chrysler, GM | Reg. | 562-065 | (559-065) | M12 x 1.25R Datsun/Nissan | Acorn |
| 562-016 | (558-016) | 1/2-20R AMC, Ford, GM | Reg. | 562-072 | (559-172) | M12 x 1.5R Ford, Imports | Reg. |
| 562-027 | (558-027) | 1/2-20R Chrysler | Reg. | 562-074 | (558-174) | 7/16-20R Chrysler, GM | Mag |
| 562-040 | (559-150) | M12 x 1.5R All | Reg. | 562-076 | (558-176) | 1/2-20R AMC, Ford, GM | Mag |
| 562-044 | (558-144) | 7/16-20R Chrysler, GM | Acorn | 562-077 | (559-077) | M12 x 1.5R Imports | Acorn |
| 562-045 | (558-140) | 7/16-20R GM | Acorn | 562-095 | (559-095) | M12 x 1.25R Datsun/Nissan | Mag |
| 562-048 | (558-148) | 1/2-20R AMC, Ford, GM | Acorn | 562-100 | (559-100) | M12 x 1.5R All | Mag |
| 562-060 | (559-060) | M10 x 1.25 Geo, GM | Acorn | 562-154 | (559-154) | M14 x 1.5R GM | Reg. |



WHEEL BOLT and NUT ASSORTMENTS ASSORTIMENTS DE BOULON et ECROUS DE ROUE



MERCHANDISER NO. 022-056

'Papco' 'Mega-Paks' are uniformly priced packages of the most popular inch & metric Wheel Bolts and Nuts. Each 'Mega-Pak' features an illustrated, colour coded label, suggested selling price and a double strength drawer box. 'Papco' 'Mega-Paks' are available individually or in a factory prepared Merchandiser No. 022-056 containing 35 sizes of the fastest selling sizes of GM, Ford, Chrysler and Import Wheel Parts.

- Sturdy, Heavy Gauge, Reinforced Steel Cabinet
- Use on Work Bench or Hang on Wall
- Colourful-Durable-Efficient
- Includes Handy Bolt Measuring Gauge

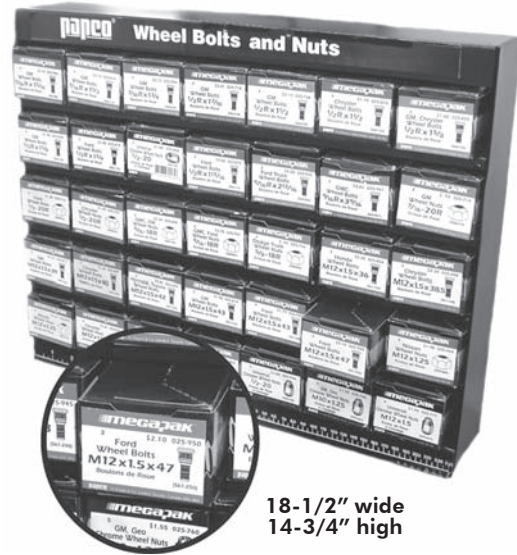

18-1/2" wide
14-3/4" high

WHEEL PARTS MERCHANDISER No. 022-056

| Part No. | Cat. No. | Pcs. | Part No. | Cat. No. | Pcs. | Part No. | Cat. No. | Pcs. | Part No. | Cat. No. | Pcs. |
|----------|-----------|------|----------|-----------|------|----------|-----------|------|----------|-----------|------|
| 025-714 | (558-014) | 8 | 025-777 | (559-077) | 4 | 025-829 | (561-129) | 4 | 025-904 | (560-604) | 3 |
| 025-716 | (558-016) | 6 | 025-800 | (558-100) | 3 | 025-838 | (560-138) | 4 | 025-945 | (561-248) | 4 |
| 025-718 | (560-018) | 3 | 025-803 | (560-103) | 4 | 025-848 | (560-148) | 4 | 025-948 | (558-148) | 4 |
| 025-727 | (558-027) | 6 | 025-808 | (561-108) | 3 | 025-850 | (559-150) | 7 | 025-950 | (561-250) | 3 |
| 025-734 | (560-034) | 4 | 025-809 | (561-109) | 4 | 025-854 | (561-154) | 3 | 025-955 | (560-355) | 2 |
| 025-744 | (558-057) | 2 | 025-810 | (561-110) | 5 | 025-855 | (560-155) | 5 | 025-961 | (560-461) | 2 |
| 025-747 | (558-047) | 3 | 025-811 | (561-111) | 5 | 025-863 | (559-163) | 2 | 025-972 | (559-172) | 4 |
| 025-760 | (559-060) | 5 | 025-814 | (560-114) | 4 | 025-872 | (560-172) | 2 | 025-986 | (560-386) | 4 |
| 025-764 | (559-064) | 4 | 025-825 | (559-125) | 4 | 025-873 | (560-173) | 2 | | | |



12" w. x 18" l. x 3" d.
020-802



9-3/4" w. x 13-3/4" l. x 2" d.
020-658



020-311

A 'Super-Service' Assortment containing 32 sizes of the most popular Wheel Bolts and Nuts for GM, Ford, Chrysler, AMC and Imports.

A Master Assortment containing 20 sizes of the most popular Wheel Bolts and Nuts for GM, Ford, Chrysler, AMC and Imports.

This Utility Assortment contains 8 sizes of the fastest moving 'Papco' Wheel Nuts.

| CONTENTS OF THE ASSORTMENT No. 020-802 | | | | | | CONTENTS OF THE ASSORTMENT No. 020-658 | | | | | | CONTENTS OF THE ASSORTMENT No. 020-311 | | | | | |
|--|------|----------|------|----------|------|--|------|----------|------|----------|------|--|------|----------|------|---------|---|
| Part No. | Pcs. | Part No. | Pcs. | Part No. | Pcs. | Part No. | Pcs. | Part No. | Pcs. | Part No. | Pcs. | Part No. | Pcs. | Part No. | Pcs. | | |
| 560-102 | 5 | 560-604 | 5 | 561-166 | 5 | 560-103 | 5 | 560-173 | 5 | 561-248 | 5 | 558-014 | 5 | 558-044 | 5 | 559-125 | 5 |
| 560-103 | 5 | 561-100 | 5 | 561-167 | 5 | 560-114 | 5 | 560-386 | 5 | 561-251 | 5 | 558-016 | 5 | 558-047 | 5 | 559-150 | 5 |
| 560-105 | 5 | 561-102 | 5 | 561-248 | 5 | 560-138 | 5 | 561-108 | 5 | 558-014 | 10 | 558-027 | 5 | 558-100 | 5 | | |
| 560-114 | 5 | 561-106 | 5 | 561-212 | 5 | 560-148 | 5 | 561-109 | 5 | 558-016 | 10 | | | | | | |
| 560-138 | 5 | 561-108 | 5 | 561-251 | 5 | 560-155 | 5 | 561-110 | 10 | 558-027 | 10 | | | | | | |
| 560-148 | 5 | 561-109 | 5 | 558-014 | 10 | 560-167 | 5 | 561-129 | 5 | 559-150 | 10 | | | | | | |
| 560-155 | 5 | 561-110 | 5 | 558-016 | 10 | 560-172 | 5 | 561-212 | 5 | | | | | | | | |
| 560-167 | 5 | 561-111 | 5 | 558-027 | 10 | | | | | | | | | | | | |
| 560-172 | 5 | 561-120 | 5 | 559-125 | 5 | | | | | | | | | | | | |
| 560-173 | 5 | 561-129 | 5 | 559-150 | 10 | | | | | | | | | | | | |
| 506-386 | 5 | 561-154 | 5 | | | | | | | | | | | | | | |



566
Series

papco

SPINDLE and AXLE NUTS
ECROUS D'ESSIEU et FUSSEE

New Axle or Spindle Nuts are recommended whenever a wheel hub, rotor, drum or CV joint is removed. Since the spindle or axle nut is relied upon to hold the wheel on the vehicle these fasteners should be replaced each time for safety.

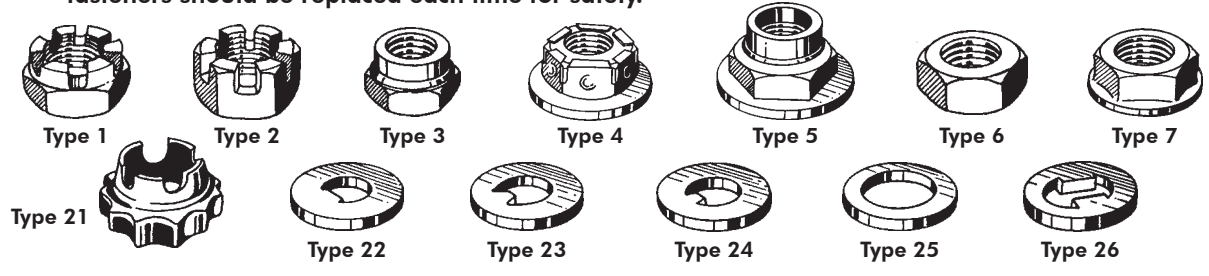

Order by Stock Number

| Stock No. | Type | Size | Hex Size | Height | Application | Std. Pkg. |
|-----------|------|------------|----------|--------|--|-----------|
| 566-057 | 1 | 27/32-20 | 1-1/4 | 13/16 | Corvette, GMC Truck | 5 |
| 566-065 | 2 | 3/4-20 | 1-1/16 | 1/2 | Buick, Cadillac, Chev, GMC, Olds, Pontiac | 5 |
| 566-072 | 6 | 3/4-16 | 1-1/16 | 3/8 | AMC, Chrysler, Ford | 5 |
| 566-074 | 6 | 13/16-20 | 1-1/8 | 3/8 | AMC, Ford, Lincoln, Mercury | 5 |
| 566-101 | 6 | 20mm x 1.5 | 30mm | 8mm | Ford, Lincoln, Mercury | 5 |
| 566-079 | 6 | 22mm x 1.5 | 32mm | 18mm | Chrysler, Nissan | 5 |
| 566-113 | 6 | 24mm x 1.5 | 35mm | 18mm | Nissan | 5 |
| 566-089 | 3 | 20mm x 1.5 | 29mm | 19mm | Buick, Cadillac, Chev, Ford, Lincoln, Mazda, Olds, Pont. | 5 |
| 566-095 | 3 | 24mm x 2.0 | 36mm | 21mm | Buick, Cadillac, Chev, Olds, Pontiac | 5 |
| 566-094 | 4 | 20mm x 1.5 | 30mm | 18mm | Ford Escort, Tempo, Mercury Lynx, Topaz | 5 |
| 566-099 | 4 | 24mm x 2.0 | 36mm | 20mm | Ford, Lincoln, Mercury | 5 |
| 566-145 | 5 | 20mm x 1.5 | 29mm | 23mm | Ford Aspire, Festiva, Geo, Mazda | 2 |
| 566-097 | 5 | 22mm x 1.5 | 32mm | 21mm | Acura, Ford, Honda, Isuzu, Mazda, Mercury, Subaru | 5 |
| 566-110 | 5 | 24mm x 1.5 | 36mm | 23mm | Acura, Honda | 2 |
| 566-146 | 5 | 26mm x 1.5 | 36mm | 23mm | Acura Legend, TL, Vigor | 2 |
| 566-144 | 7 | 27mm x 2.0 | 34mm | 18mm | Buick, Chev, Olds, Pontiac | 2 |
| 566-073 | 21 | N/A | | | Retainer for 566-072 | 5 |
| 566-075 | 21 | N/A | | | Retainer for 566-074 | 5 |
| 566-080 | 21 | N/A | | | Retainer for 566-079 | 5 |
| 566-102 | 21 | N/A | | | Retainer for 566-101 | 5 |
| 566-149 | 21 | N/A | | | Retainer for 566-113 | 2 |
| Stock No. | Type | I.D. | O.D. | Thick | Application | Std. Pkg. |
| 566-219 | 22 | 3/4 | 1-21/32 | 3/32 | Use with 566-072 | 5 |
| 566-212 | 23 | 27/32 | 1-21/32 | 7/64 | Use with 566-057 | 5 |
| 566-207 | 23 | 27/32 | 2-1/16 | 11/64 | Use with 566-065, 566-057 | 5 |
| 566-229 | 23 | 20.1mm | 41.8mm | 3.0mm | Use with 566-101 | 5 |
| 566-205 | 24 | 3/4 | 1-21/32 | 3/32 | Use with 566-065, 566-072 | 5 |
| 566-234 | 24 | 23.5mm | 46.9mm | 4.6mm | Use with 566-097 | 5 |
| 566-226 | 25 | 20.2mm | 39.8mm | 4.1mm | Use with 566-089 | 5 |
| 566-215 | 25 | 21.5mm | 36.0mm | 3.7mm | Use with 566-089 | 5 |
| 566-227 | 25 | 24.7mm | 45.1mm | 4.7mm | Use with 566-095 | 5 |
| 566-228 | 25 | 24.9mm | 49.0mm | 6.1mm | Use with 566-095 | 5 |
| 566-233 | 26 | 3/4 | 1-21/32 | 3/32 | Use with 566-072 | 5 |

For Applications of 'Papco' Spindle and Axle Nuts see current Wheel Parts catalogue.

papco WHEEL HUB DUST CAPS

'Papco' Wheel Hub Dust Caps prolong bearing life by preventing road grime, dust, dirt, or road salt from entering the wheel bearing.

Order by Stock Number Individually Carded



| Stock No. | O.D. | Description |
|-----------|---------|--|
| 566-301 | 1-25/32 | GM, Ford, Chrysler, Honda, Nissan, AMC |
| 566-302 | 2-3/32 | General Motors |
| 566-303 | 1-31/32 | Ford Pickups and Vans with light duty brakes |



569
Series

papco WIRING TERMINALS
COSSE SANS SOUDRE

INSULATED SOLDERLESS TYPE

'Papco' Wiring Terminals are constructed from pure electrolytic copper, annealed and electro-tin plated. The one-piece construction provides a terminal of maximum strength and electrical conductivity. The electro-tin plating affords maximum protection against corrosion. Funnel barrel entry assures easy wire insertion and a positive, solid crimp.

Insulation is colour coded for the appropriate wire gauge: Red 22-18, Blue 18-14 and Yellow 12-10.

| 22-18 WIRE GAUGE CAL DU FIL | | | |
|------------------------------------|--------------------|-----------|--------------|
| Stock No. | Type | Stud Size | Pcs. Per Box |
| 569-415 | RING | #4-#6 | 50 |
| 569-420 | RING | #8-#10 | 50 |
| 569-421 | RING | #12-#14 | 50 |
| 569-422 | MULTI FIT | #6-#10 | 50 |
| 569-424 | HOOK | #8-#10 | 50 |
| 569-425 | SPADE | #4-#6 | 50 |
| 569-426 | SPADE | #8-#10 | 50 |
| 569-432 | BUTT | - | 50 |
| 569-435 | INSUL. QUICK DISC. | 1/4 F | 25 |
| 569-436 | INSUL. QUICK DISC. | 1/4 M | 25 |
| 18-14 WIRE GAUGE CAL DU FIL | | | |
| 569-460 | RING | #4-#6 | 50 |
| 569-461 | RING | #8-#10 | 50 |
| 569-462 | RING | #12-1/4 | 50 |
| 569-464 | MULTI FIT | #6-#10 | 50 |

| 18-14 WIRE GAUGE CAL DU FIL | | | |
|------------------------------------|----------------------|---|--------------|
| Stock No. | Type | Stud Size | Pcs. Per Box |
| 569-465 | HOOK | #8-#10 | 50 |
| 569-466 | SPADE | #4-#6 | 50 |
| 569-467 | SPADE | #8-#10 | 50 |
| 569-468 | 'SNAP' SPADE | #8 | 50 |
| 569-469 | 'SNAP' SPADE | #10 | 50 |
| 569-470 | THREE WAY | - | 25 |
| 569-473 | BUTT | - | 50 |
| 569-474 | QUICK DISC. | 1/4 F | 50 |
| 569-475 | QUICK DISC. | 1/4 M | 50 |
| 569-476 | INSUL. QUICK DISC. | 1/4 F | 25 |
| 569-477 | INSUL. QUICK DISC. | 1/4 M | 25 |
| 569-478 | BULLET | - | 50 |
| 569-500 | 'SPEE-DEE' CONNECTOR | Make safe, fast, dependable connections. No wire stripping - no cutting - works on 14-18 wire gauge. Use standard pliers. The snap cover gives a completely insulated connection. Polypropylene case maintains live action. 25 pcs. | |

| 18-14 WIRE GAUGE CAL DU FIL | | | |
|------------------------------------|--------------------|--|--------------|
| Stock No. | Type | Stud Size | Pcs. Per Box |
| 569-525 | 8-478 RECER | - | 25 |
| 12-10 WIRE GAUGE CAL DU FIL | | | |
| 569-511 | RING | #8-#10 | 50 |
| 569-512 | RING | #12-#14 | 50 |
| 569-513 | RING | 5/16-3/8 | 50 |
| 569-531 | MULTI FIT | #6-#10 | 25 |
| 569-516 | SPADE | #8-#10 | 50 |
| 569-522 | BUTT | - | 50 |
| 569-523 | INSUL. QUICK DISC. | 1/4 F | 25 |
| 569-524 | INSUL. QUICK DISC. | 1/4 M | 25 |
| 569-529 | CLOSED END | - | 50 |
| 569-530 | 'T-TAP' CONNECTORS | Use in trunk to trailer hook-ups. T-splice stop lights and turn signals without stripping wires. Snap plug allows easy disconnect. 25 pcs. | |

For other assortments of 'Papco' Wiring Terminals and Crimping Tools see next page.

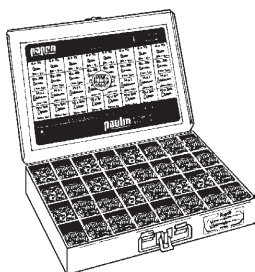

papco SUPER SERVICE ASSORTMENT No. 020-812

Contains 500 Wiring Terminals - complete coverage of all sizes listed. Large size, rigid metal box with high-strength plastic compartments.

For more details see page 9.

Large size: 12" w. x 18" l. x 3" d.



papco® WIRING TERMINALS COSSE SANS SOUDRE



GARAGE ASSORTMENT No. 020-067

Contains 45 Ring, Spade, Multi-Fit and Butt Terminals.
15 sizes packed in a rigid, transparent plastic box.

MASTER ASSORTMENT No. 020-650

This assortment contains 32 items for a total of 325 pieces of the most popular Ring, Spade, Hook, Butt and Quick Disconnect Terminals. Metal box with moulded plastic compartments features grease resistant lid label with actual size illustrations a handy wire size and stud size chart.

Size: 9-3/4" w. x 13-3/4" l. x 2" d.



CRIMPING TOOL OUTIL COSSE

No. 569-300

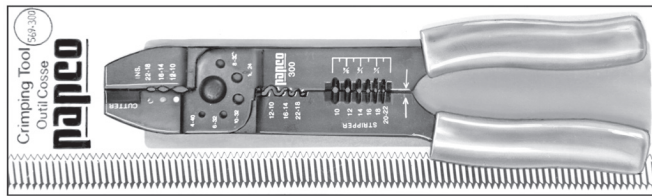

Five in one 'Papco' Crimping Tool is capable of performing five operations: Crimper (both insulated and non-insulated), Wire Cutter, Wire Stripper and Bolt Cutter. Individually carded.

Order by Card No. 569-300

569
Series



CABLE TIES SANGLES POUR CABLE



Standard Type



Mounting Type

Self-locking Nylon ties for quick, simple bundling and mounting. Material is High Strength Black Nylon 6/6 for increased resistance to outdoor exposure and ultra-violet light. Use to secure wiring harness, cables, hose, wires and pipes, and to prevent damage from moving parts or hot engine components. Packed in handy, sealed poly-bags in quantities shown.

Order by Stock Number

| Stock No. | Bundle Dia. | Length | Tensile Strength | Std. Pkg. |
|----------------------|-------------|---------|------------------|-----------|
| STANDARD TIES | | | | |
| 569-701 | 3/4" | 4" | 18 lbs. | 100 |
| 569-704 | 1-1/4" | 5-1/2" | 40 lbs. | 100 |
| 569-706 | 2" | 8" | 50 lbs. | 100 |
| 569-708 | 4" | 14-1/2" | 50 lbs. | 10 |
| 569-710 | 4" | 14-1/2" | 120 lbs. | 10 |
| MOUNTING TIES | | | | |
| 569-714 | 2" | 8" | 50 lbs. | 25 |

ASSORTMENT No. 569-700

This assortment of 24 popular 8" ties contains 6 each of 4 colours, red, yellow, blue and black. Use to bundle and identify up to 2" diameter wiring, etc. Packed in a clear poly-bag with header label.

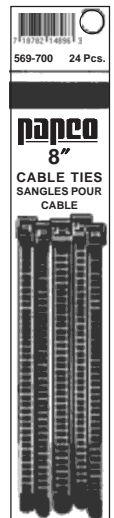

569
Series

papeo

**WIRE GROMMETS
BAGUES POUR FIL**



Oil Resistant Black Vinyl

Prevents insulation damage, shorts and leaks.

Order by Stock Number

Standard Package 10 Pieces

| Stock No. | Size | Stock No. | Size |
|-----------|-----------------------|-----------|---------------------|
| 569-232 | 1/4 O.D. x 1/8 I.D. | 569-236 | 1/2 O.D. x 3/8 I.D. |
| 569-233 | 5/16 O.D. x 3/16 I.D. | 569-238 | 5/8 O.D. x 1/2 I.D. |
| 569-234 | 3/8 O.D. x 1/4 I.D. | 569-240 | 7/8 O.D. x 5/8 I.D. |

papeo

**FUSE ACCESSORIES
ACCESORIES POUR FUSIBLE**

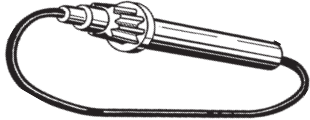

569-029



569-030

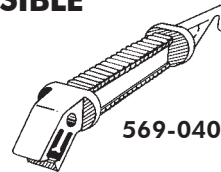

569-040

Order by Stock Number

Standard Package 5 Pieces

| Stock No. | Description |
|-----------|--|
| 569-029 | In-line Fuse Holder with 10AMP Fuse, 12ga. wire. |
| 569-030 | Blade (ATO) Type Fuse Holder for 3 to 20AMP Fuses. |
| 569-040 | Dual Universal Fuse Puller removes and installs glass or blade type fuses. |

papeo

**SHRINK TUBING
TUBE RETRAIT**

Order by Stock Number

| Stock No. | Size | Std. Pkg. |
|-----------|----------------|-----------|
| 569-200 | 3/16 I.D. x 3" | 25 |
| 569-201 | 1/4 I.D. x 3" | 25 |
| 569-203 | 3/8 I.D. x 3" | 25 |

Insulates, groups and weather proofs wiring connections. Charcoal grey tubing can be cut easily to suit length required. Shrink with warm air blower.

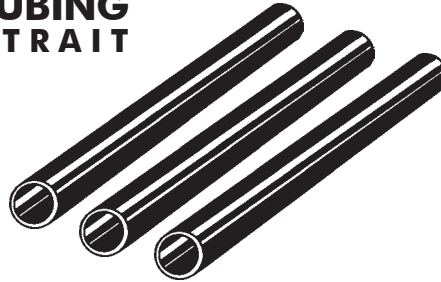

papeo **CIRCUIT TESTERS
VERIFICATEUR DE CIRCUIT**

Tests for voltage presence in circuits. Locates improper connections, shorts and broken wires.

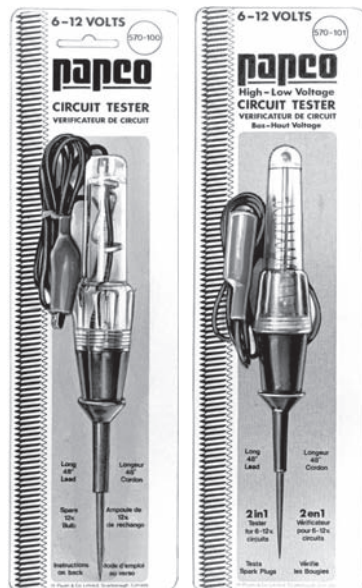

570-100

570-101

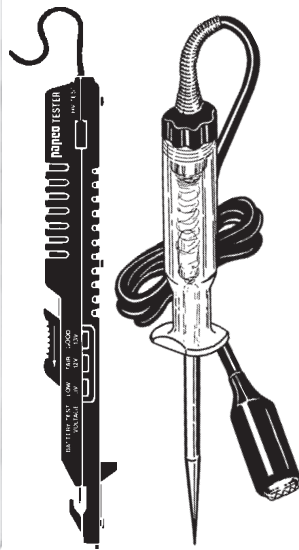

570-103

570-105

**No. 570-100
6-12 Volts CIRCUIT TESTER**

The most popular and largest selling tester. Quickly and accurately tests all 6 to 12V systems. Includes a spare bulb and extra long 48" lead. Individually carded.

**No. 570-101
HI-LO VOLTAGE CIRCUIT TESTER**

All the proven features of the popular Part No. 570-100 Circuit Tester - plus the ability to test Hi-Voltage circuits such as Spark Plugs. Checks for broken insulators, excessive gap, poor wire, fouled or worn spark plugs.

**No. 570-103
LED DISPLAY AUTO CIRCUIT TESTER**

Professional quality Hi-Lo Voltage Circuit Tester accurately and quickly tests live wires, batteries and ignition systems including Spark Plugs. LED Display on side of tester indicates degree of battery charge. Individually carded.

**No. 570-105
6, 12, 24 Volts CIRCUIT TESTER**

Professional quality tester features unbreakable plastic handle, heavy duty ground clip, 60" long rubber coated, heavy duty lead wire. Tests all 6, 12 and 24 Volts systems with power on. Individually carded.



570
Series

papeco TEST CLIPS PINCES DE VERIFIER

ALLIGATOR TYPE

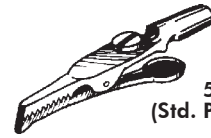

570-129
(Std. Pkg. 10 Clips)

A handy clip used in test work on ignition, Radio and Electrical applications. Strong, slim jaws with nesting teeth for good contact. Bright plated steel - 2" long - 3/8" jaw spread.

Order by Stock Number 570-129

Standard Package 10 Clips

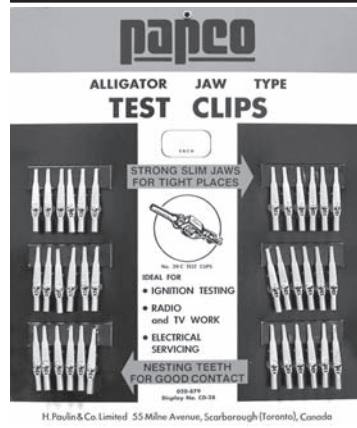

**ASSORTMENT
DISPLAY
No. 020-879**

Contains 36 Alligator Type Test Clips No. 570-129. Attractive three colour point of purchase display card.

020-879

**CARD No.
570-139**

Convenient skin-packed card contains four Alligator Type Test Clips. Order by Card No.



**Card No.
570-139**

papeco CHARGING CLIPS PINCES DE CHARGE

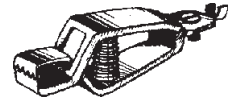

- 'Bull-dog' teeth for positive contact.
- Heavily plated to resist corrosion.
- Feed-thru neck prevents twisting.
- Oversize screw head for easier wiring.

Order by Stock Number

Standard Package 10 Clips

| Stock No. | Size | Capacity | Jaw Spread | Length |
|-----------|--------|----------|------------|--------|
| 570-130 | Small | 10 AMP | 1/2" | 2" |
| 570-131 | Medium | 30 AMP | 1" | 2-7/8" |
| 570-134 | Large | 50 AMP | 1-1/4" | 4" |



570-110

TEST LEADS FILS DE VERIFIER

CARD No. 570-110

Electrical test leads for auto, marine, hobby, shop, household and many other applications. Quickly shows hidden trouble in electrical systems. Consists of one black and one red extra long 48" leads complete with insulated, plated steel alligator clips fitted to both ends. Individually packaged.



Convenient skin-packed card contains four Charging Clips. Three sizes available. Order by Card No.

| Card No. | Capacity |
|----------|----------|
| 570-140 | 10 AMP |
| 570-141 | 30 AMP |
| 570-144 | 50 AMP |

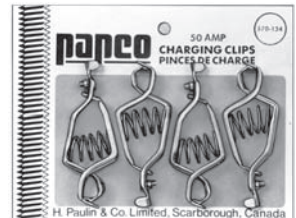

papeco BATTERY TERMINAL and GEAR PULLERS ARRACHES-COSSES/PIGNONS

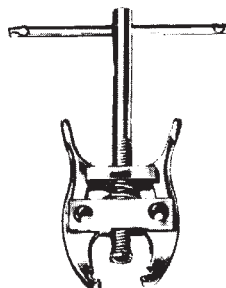

CARD No. 570-260

Use this popular tool to raise the Terminal off the post. A few turns applies even pressure without risk of damage. Individually Carded. Order by Card Number 570-260.

CARD No. 570-264

Professional quality. High-strength arms of drop forged steel. Thin jaws, for battery terminals and gears with small clearance. Pulls gears up to 1-1/2" diameter. Bright Plated. Individually Carded. Order by Card Number 570-264.

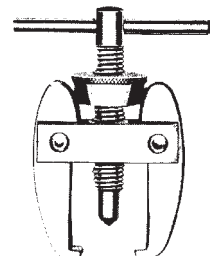

570
Series



papco BATTERY TERMINALS COSSES DE BATTERIE



All 'Papco' Battery Terminals are made of Lead Alloy.

Order by Stock Number

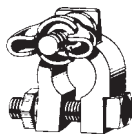
Standard Package 25 terminals.

| | | | |
|---|---|---|--|
| <p>Stock No. 570-346</p>  <p>UNIVERSAL SIDE MOUNT TERMINAL No. 00 down to No. 6 gauge</p> | <p>Stock No. 570-366</p>  <p>UNIVERSAL MARINE TERMINAL No. 00 down to No. 6 gauge</p> | <p>Stock No. 570-376</p>  <p>UNIVERSAL STRAIGHT TYPE TERMINAL Gauge 0 and 1</p> | <p>Stock No. 570-395</p>  <p>UNIVERSAL TERMINAL No. 00 down to No. 6 gauge</p> |
|---|---|---|--|

020-870

UNIVERSAL BATTERY TERMINAL COSSE DE BATTERIE UNIVERSEL

SOLDERLESS TYPE

**ASSORTMENT
DISPLAY
No. 020-870**

Contains 10 Universal Solderless Battery Terminals No. 570-395 (see above). Attractive three colour display card.

CARD No. 570-396

Universal Solderless Battery Terminal holds No. 00 down to No. 6 gauge. Top plate reverses - holds flat strap or smaller wire. Fits positive or negative posts.



Card No. 570-396

020-868

UNIVERSAL MARINE BATTERY TERMINAL COSSE DE BATTERIE TYPE MARIN UNIVERSEL

SOLDERLESS TYPE

**ASSORTMENT
DISPLAY
No. 020-868**

Contains 10 Universal Marine Type Battery Terminals No. 570-366 (see above). Attractive three colour display card.

CARD No. 570-397

Universal Marine Type Battery Terminal holds No. 00 down to No. 6 gauge. Forged Brass for high conductivity. Heavily plated. Fits positive or negative posts.

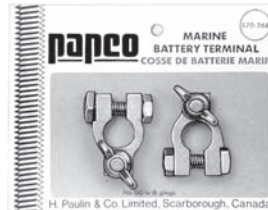

Card No. 570-397

020-869

UNIVERSAL SIDE TERMINAL COSSE DE BATTERIE LATERAL UNIVERSEL

SOLDERLESS TYPE

**ASSORTMENT
DISPLAY
No. 020-869**

Contains 8 Universal Side Terminals No. 570-346 (see above). Attractive, three colour point of purchase display card.

CARD No. 570-398

Universal Side Terminals fits both positive and negative posts. Convenient skin-packed card contains two terminals. Order by Card Number.



Card No. 570-398

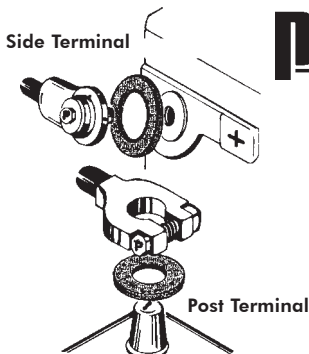

papco BATTERY TERMINAL PROTECTORS PROTECTEURS DE COSSE DE BATTERIE

Special polyester pad impregnated with a chemical corrosion inhibitor that prevents power robbing corrosion build-up. Extends life of terminals and hold downs. Easily installed. Skin-packed two per card.

Order By Card Number

| Card No. | Application |
|----------|-----------------------------------|
| 570-425 | Side Mount Type Battery Terminals |
| 570-426 | Post Type Battery Terminals |





570
Series

papeco

BATTERY BOOSTER CLAMPS COLLIERS DE CHARGE-BATTERIE



020-889

**ASSORTMENT
DISPLAY
No. 020-889**

Five pair 500 AMP Professional Duty clamps with vinyl insulated, non-slip handles on attractive three colour point of purchase display card. Our finest booster clamp.

500 AMP

**CARD No.
570-245**

500 AMP Professional Duty clamp made of heavy gauge steel, bright nickel plated complete with cable lug. Colour coded vinyl, non-slip insulated handles. Our finest booster clamp. Convenient skin-packed card contains two clamps - one red, one black. Order by Card Number.

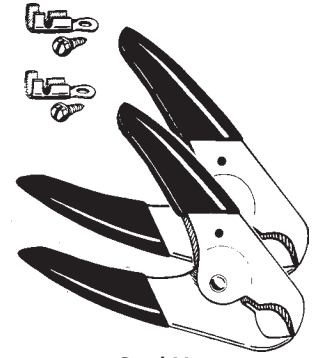

Card No.
570-245

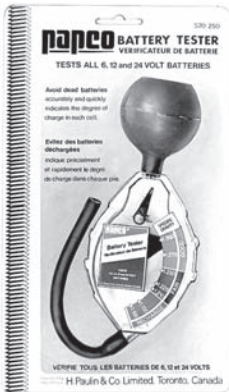

BATTERY TESTER VERIFICATEUR DE BATTERIE

No. 570-250

Tests all 6, 12 and 24 Volt Batteries

Accurately and quickly indicates the degree of charge in each cell. Individually blister-packed. Order by Part Number 570-250

BATTERY BOOSTER ADAPTORS For Side Terminals No. 570-200

Made of copper plated heavy duty steel for maximum conductivity. For use on all side terminal batteries. Installs between the terminal and the battery. Makes an ideal charging connection for hard-to-reach and hard-to-grip side mount terminals.



UNIVERSAL BATTERY and CHARGING POST No. 570-344

For Side Mount Batteries

Use two ways:

- (1) As Charging Post - just screw into side mount battery and attach booster clamps.
- (2) As Battery Post - screw into side mount battery and it becomes a post - attach conventional terminals.

Card No.
570-344

Convenient skin-packed card contains 2 complete charging post.

UNIVERSAL SIDE-MOUNT TERMINAL RATCHET WRENCH No. 570-345

Fits all OEM Side Mount Terminals. Reversible ratchet wrench for easy terminal installation or removal. Also fits most brake bleeder screws. Compact size for easy access.

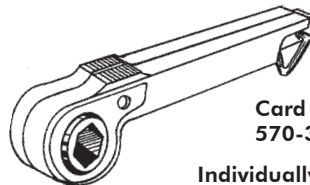

Card No.
570-345

Individually Carded

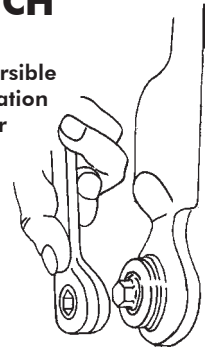

papeco BATTERY POST and TERMINAL CLEANERS NETTOIE-BORNES/ COSSES

No. 570-270

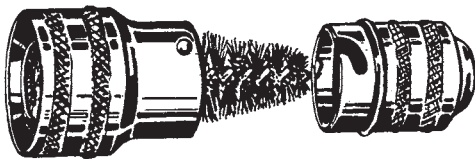

This tool quickly removes corrosion and scale from the terminal. Wire brush in base cleans the battery post. Helps maintain metal-to-metal contact. Individually Carded. Order by Card Number 570-270

No. 570-275

Professional type, heavy duty one piece tool. Quickly and easily removes corrosion and dirt build-up that causes grounding on battery posts and terminals. Specially designed and clearly marked for cleaning either positive or negative posts. Tapered reamer for cleaning all post type battery terminals.

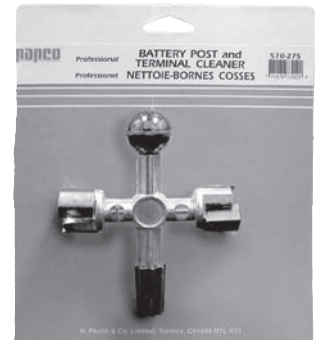



570
Series

papeco

BATTERY HOLD DOWN BOLTS
BOULONS DE FIXE-BATTERIE

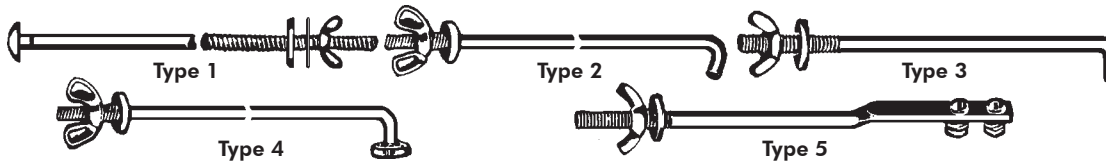

All Bolts are Plated and include Wing Nut and Washer. Convenient skin-packed cards contain two (2) complete Bolts. Order by Card Number.

| Card No. | Type | Size | Description | Thread | Application | Factory No. |
|----------|------|-----------------|---------------------------------|--------|--------------------------------|-------------|
| 570-610 | 2 | 1/4-20 x 10-1/2 | Round Hook | 4" | Universal | |
| 570-611 | 2 | 1/4-20 x 10 | Round Hook | 4" | Universal | |
| 570-612 | 1 | 5/16-18 x 12 | Carr. Head | 5-1/2" | Universal | |
| 570-613 | 2 | 5/16-18 x 12 | Round Hook | 5" | Universal | |
| 570-614 | 3 | 1/4-20 x 10-1/4 | Right Angle | 4" | Universal | |
| 570-615 | 2 | 5/16-18 x 7-1/2 | Round Hook | 4" | G.M. Products | 3688699 |
| 570-616 | 5 | 3/8-16 x 6 | Flat End with 2 mount. scrs. | 2-1/4" | Chrysler Prod. (outer bolt) | |
| 570-617 | 4 | 3/8-16 x 10-1/4 | Spoke Hook | 1-1/2" | Chrysler (inner) | 1408918 |



MASTER ASSORTMENT No. 020-628

- Contains 34 Bolts, 130 pieces. 7 sizes complete with nuts and washers.
- All metal box - hinged lid.
- Handy carrying handle with safety snap lock.
- Illustrated label shows every part.

Garages - Super Service Stations - can replace any Battery Hold Down Bolt with the complete coverage of this assortment.

Metal Merchandiser

UNIVERSAL BATTERY HOLD DOWNS
FIXE-BATTERIE UNIVERSEL

These four styles fit most popular batteries. Made of vinyl coated steel or nylon*, highly resistant to rust and corrosion. Individually skin-packed* on an attractive three colour display card. Order by Card Number. Contains all necessary hardware.

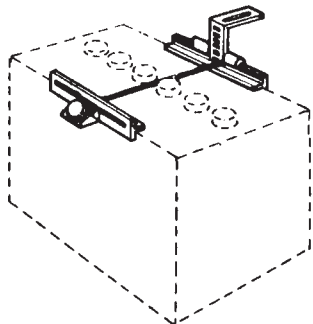

Card No. 570-508
Universal cross bar type fits battery groups 22F, 24, 27, 60.

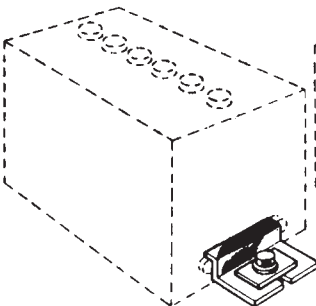

Card No. 570-509
Universal end type for base mount battery groups 22NF, 27F and 29NF.

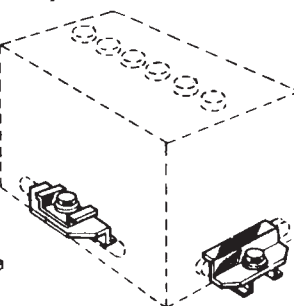

Card No. 570-510
Universal side type for side mount battery groups 22F and 24C also end mount group 22F.

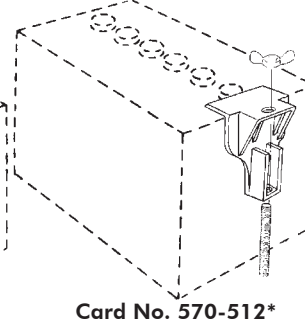

Card No. 570-512*
Contains two Univ. Battery Hold Down clamps. Holds all types of batteries securely. Strong, flexible nylon will not break or corrode.

papeco

BATTERY TERMINAL BOLTS and NUTS
BOULONS et ECROUS POUR COSSE DE BATTERIE

Stock No. 570-410



5/16 x 1-1/4 Bolt and Nut

Standard Package 100 Pieces

Stock No. 570-411



5/16-18 Nut

Stock No. 570-412



5/16 x 1-1/4 Shoulder Bolt and Nut

Stock No. 570-413

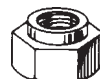

5/16-18 Shoulder Nut

Stock No. 570-415



3/8 x 7/16 Side Terminal Bolt



5000 Series



18.8 STAINLESS STEEL FASTENERS ATTACHES ACIER INOXYDABLE 18.8

Corrosion resistant Type 300 Series (18% chromium - 8% nickel). Used in Marine applications, food processing equipment and wherever resistance to most acids and chemicals is required. Non-magnetic. UNC thread.

Order by Stock Number



18.8 HEX CAP SCREWS and NUTS



| | Dia. | 1/4-20 | Std. Pkg. | 5/16-18 | Std. Pkg. | 3/8-16 | Std. Pkg. | 1/2-13 | Std. Pkg. |
|----------|-------|----------|-----------|----------|-----------|----------|-----------|----------|-----------|
| Length | 3/4 | 5000-307 | 100 | 5000-442 | 100 | 5000-487 | 100 | — | — |
| | 1 | 5000-309 | 100 | 5000-444 | 100 | 5000-489 | 100 | 5000-579 | 25 |
| | 1-1/2 | 5000-313 | 100 | 5000-448 | 100 | 5000-493 | 100 | 5000-583 | 25 |
| | 2 | 5000-316 | 100 | 5000-451 | 100 | 5000-496 | 100 | 5000-586 | 20 |
| | 2-1/2 | 5000-318 | 50 | 5000-453 | 50 | 5000-498 | 50 | 5000-588 | 20 |
| | 3 | 5000-320 | 25 | 5000-455 | 25 | 5000-500 | 25 | 5000-590 | 10 |
| Hex Nuts | | 5026-014 | 100 | 5026-016 | 100 | 5026-018 | 100 | 5026-022 | 50 |



18.8 FLAT WASHERS

Standard Package 100 Pcs., *50 Pcs.

| Stock No. | Bolt Size | I.D. | O.D. | Thick. |
|-----------|-----------|-------|-------|--------|
| 5055-206 | #6 | .147 | 3/8 | .031 |
| 5055-208 | #8 | .172 | 3/8 | .031 |
| 5055-210 | #10 | .200 | 7/16 | .037 |
| 5055-214 | 1/4 | .265 | 11/16 | .050 |
| 5055-216 | 5/16 | 11/32 | 3/4 | .050 |
| 5055-218 | 3/8 | 25/64 | 7/8 | .062 |
| 5055-222* | 1/2 | 9/16 | 1-1/4 | .078 |



18.8 REGULAR LOCK WASHERS

Std. Package 100 Pcs.

| Stock No. | Bolt Size |
|-----------|-----------|
| 5058-014 | 1/4 |
| 5058-016 | 5/16 |
| 5058-018 | 3/8 |
| 5058-022 | 1/2 |



18.8 FINISHING WASHERS

Std. Package 100 Pcs.

| Stock No. | Screw Size |
|-----------|------------|
| 5056-971 | #6 |
| 5056-973 | #8 |
| 5056-975 | #10 |
| 5056-979 | 1/4 |



18.8 NYLON INSERT LOCK NUTS

| Stock No. | Bolt Size | Std. Pkg. |
|-----------|-----------|-----------|
| 5034-006 | 6-32 | 100 |
| 5034-008 | 8-32 | 100 |
| 5034-010 | 10-24 | 100 |
| 5034-011 | 10-32 | 100 |
| 5034-014 | 1/4-20 | 100 |
| 5034-016 | 5/16-18 | 100 |
| 5034-018 | 3/8-16 | 100 |
| 5034-022 | 1/2-13 | 50 |

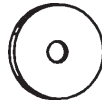

18.8 FENDER WASHERS

| Stock No. | Bolt Size | Outside Diameter | Std. Pkg. |
|-----------|-----------|------------------|-----------|
| 5057-394 | No. 10 | 1" | 100 |
| 5057-395 | 1/4 | 1-1/4 | 100 |
| 5057-396 | 5/16 | 1-1/2 | 100 |
| 5057-398 | 3/8 | 1-1/2 | 100 |
| 5057-400 | 1/2 | 2" | 50 |



18.8 STAINLESS COTTER PINS

| Stock No. | Size | Std. Pkg. |
|-----------|--------------|-----------|
| 5080-091 | 3/32 x 1 | 100 |
| 5080-095 | 3/32 x 1-1/2 | 100 |
| 5080-141 | 1/8 x 1 | 100 |
| 5080-145 | 1/8 x 1-1/2 | 100 |
| 5080-148 | 1/8 x 2 | 100 |
| 5080-171 | 5/32 x 1-1/2 | 100 |
| 5080-174 | 5/32 x 2 | 100 |



18.8 STAINLESS CARRIAGE BOLTS

| Stock No. | Size | Std. Pkg. |
|-----------|--------------|-----------|
| 5002-309 | 1/4 x 1 | 100 |
| 5002-313 | 1/4 x 1-1/2 | 100 |
| 5002-316 | 1/4 x 2 | 100 |
| 5002-318 | 1/4 x 2-1/2 | 50 |
| 5002-320 | 1/4 x 3 | 50 |
| 5002-444 | 5/16 x 1 | 50 |
| 5002-448 | 5/16 x 1-1/2 | 50 |
| 5002-451 | 5/16 x 2 | 50 |
| 5002-453 | 5/16 x 2-1/2 | 25 |
| 5002-455 | 5/16 x 3 | 25 |
| 5002-489 | 3/8 x 1 | 50 |
| 5002-493 | 3/8 x 1-1/2 | 50 |
| 5002-496 | 3/8 x 2 | 25 |
| 5002-498 | 3/8 x 2-1/2 | 25 |
| 5002-500 | 3/8 x 3 | 25 |
| 5002-504 | 3/8 x 4 | 10 |



18.8 STAINLESS LAG BOLTS

| Stock No. | Size | Std. Pkg. |
|-----------|--------------|-----------|
| 5003-309 | 1/4 x 1 | 50 |
| 5003-313 | 1/4 x 1-1/2 | 50 |
| 5003-316 | 1/4 x 2 | 50 |
| 5003-318 | 1/4 x 2-1/2 | 25 |
| 5003-320 | 1/4 x 3 | 25 |
| 5003-448 | 5/16 x 1-1/2 | 50 |
| 5003-451 | 5/16 x 2 | 50 |
| 5003-453 | 5/16 x 2-1/2 | 25 |
| 5003-455 | 5/16 x 3 | 25 |
| 5003-493 | 3/8 x 1-1/2 | 50 |
| 5003-496 | 3/8 x 2 | 50 |
| 5003-498 | 3/8 x 2-1/2 | 25 |
| 5003-500 | 3/8 x 3 | 25 |
| 5003-504 | 3/8 x 4 | 20 |
| 5003-586 | 1/2 x 2 | 50 |
| 5003-590 | 1/2 x 3 | 25 |
| 5003-594 | 1/2 x 4 | 20 |



18.8 STAINLESS SOCKET CAP SCREWS

| Stock No. | Size | Std. Pkg. |
|-----------|--------------|-----------|
| 5007-309 | 1/4 x 1 | 100 |
| 5007-313 | 1/4 x 1-1/2 | 100 |
| 5007-316 | 1/4 x 2 | 100 |
| 5007-444 | 5/16 x 1 | 100 |
| 5007-448 | 5/16 x 1-1/2 | 100 |
| 5007-451 | 5/16 x 2 | 100 |
| 5007-453 | 5/16 x 2-1/2 | 100 |
| 5007-489 | 3/8 x 1 | 100 |
| 5007-493 | 3/8 x 1-1/2 | 100 |
| 5007-496 | 3/8 x 2 | 50 |
| 5007-498 | 3/8 x 2-1/2 | 50 |
| 5007-500 | 3/8 x 3 | 50 |
| 5007-579 | 1/2 x 1 | 50 |
| 5007-583 | 1/2 x 1-1/2 | 50 |
| 5007-586 | 1/2 x 2 | 50 |
| 5007-588 | 1/2 x 2-1/2 | 25 |
| 5007-590 | 1/2 x 3 | 25 |

For a complete listing of non-ferrous and stainless fasteners see separate "Papco" Corrosion Resistant Catalogue.



5000
Series



18.8 STAINLESS STEEL FASTENERS ATTACHES ACIER INOXYDABLE 18.8

18.8 MACHINE SCREWS - PHILLIPS

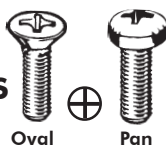

Std. Pkg. 100 Pcs.

| Size | Stock No.'s | |
|----------------|-------------|----------|
| | Oval | Pan |
| 6-32 x 1/2 | 5113-087 | 5114-087 |
| 6-32 x 1 | 5113-091 | 5114-091 |
| 8-32 x 1 | 5113-141 | 5114-141 |
| 10-24 x 1 | 5113-193 | 5114-193 |
| 10-24 x 1-1/2 | 5113-197 | 5114-197 |
| 10-24 x 2 | 5113-200 | 5114-200 |
| 1/4-20 x 1-1/2 | 5113-313 | 5114-313 |
| 1/4-20 x 2 | 5113-316 | 5114-316 |

18.8 FLAT SOCKET TAPPING SCREWS



Std. Pkg. 100 Pcs. Flat Socket

| Stock No. | Size |
|-----------|------------|
| 5162-089 | 6 x 3/4 |
| 5162-139 | 8 x 3/4 |
| 5162-141 | 8 x 1 |
| 5162-193 | 10 x 1 |
| 5162-195 | 10 x 1-1/4 |
| 5162-197 | 10 x 1-1/2 |
| 5162-254 | 12 x 1-1/2 |

18.8 TAPPING SCREWS TYPE A



Std. Package 100 Pcs. Pan Oval

| Size | Stock No.'s | |
|----------|-------------|----------|
| | Pan | Oval |
| 4 x 1/2 | 5163-043 | 5165-043 |
| 6 x 3/4 | 5163-089 | 5165-089 |
| 6 x 1 | 5163-091 | 5165-091 |
| 8 x 3/4 | 5163-139 | 5165-139 |
| 8 x 1 | 5163-141 | 5165-141 |
| 10 x 3/4 | 5163-191 | 5165-191 |
| 10 x 1 | 5163-193 | 5165-193 |



18.8 HEX MACHINE SCREW NUTS

| Size | Stock No. | Std. Pkg. |
|--------|-----------|-----------|
| 6-32 | 5035-006 | 100 |
| 8-32 | 5035-008 | 100 |
| 10-24 | 5035-010 | 100 |
| 1/4-20 | 5035-014 | 100 |

For a complete listing of non-ferrous and stainless fasteners see separate 'Papco' Corrosion Resistant Catalogue.



18.8 STAINLESS STEEL THREADED RODS

Standard Package as Required.

| Stock No. | Size | Stock No. | Size |
|-----------|---------------|-----------|---------------|
| 5091-310 | 10-24 x 36" | 5091-354 | 1/4-20 x 72" |
| 5091-314 | 1/4-20 x 36" | 5091-356 | 5/16-18 x 72" |
| 5091-316 | 5/16-18 x 36" | 5091-358 | 3/8-16 x 72" |
| 5091-318 | 3/8-16 x 36" | 5091-362 | 1/2-13 x 72" |
| 5091-322 | 1/2-13 x 36" | 5091-364 | 5/8-11 x 72" |
| 5091-324 | 5/8-11 x 36" | 5091-366 | 3/4-10 x 72" |
| 5091-326 | 3/4-10 x 36" | | |

Note: Fine Thread 36" long Threaded Rods are available - price on application.

STAINLESS STEEL GARAGE ASSORTMENT

No. 020-212



Contains 110 pieces - 8 sizes of Pan and Oval Socket 18.8 Stainless Steel Tapping Screws and 2 sizes of 18.8 Stainless Finishing Washers packed in a transparent plastic box.

MARINE FASTENER ASSORTMENT

This Master Assortments is ideal for the boat owner for attaching railings, brackets, swivels, posts and other marine equipment and accessories. Each product is fully illustrated on the price coded lid label. Excellent for self-serve sales. Metal box with high strength, moulded plastic compartments and safety locking lid.

MASTER ASSORTMENT

No. 020-673

Contains 20 sizes of Stainless Steel Tapping Screws, Wood Screws, Machine Screws, Nuts and Finishing Washers.



263
Series



MARINE DRAIN PLUGS

BOUCHONS DE VIDANGE TYPE MARIN

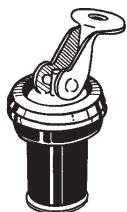

263-652
to
263-660

These reusable expandable neoprene plugs will seal openings during leak testing or painting and can be used as permanent stoppers. Marine applications include boat drain outlet stoppers, bait plugs etc. Plugs are adjustable to control seal pressure as brass cam handle expands rubber body. Metal parts are brass and stainless. Do not use to cap edible products.

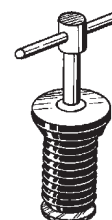

263-650

Order by Stock Number

Standard Package 5 Pieces

| Stock No. | Fits Opening I.D. | Description | Stock No. | Fits Opening I.D. | Description |
|-----------|-------------------|-------------------------|-----------|-------------------|-------------------------|
| 263-650 | 1" | Tee Handle, 1" long | 263-656 | 5/8" | Cam Handle, 11/16" long |
| 263-652 | 3/8" | Cam Handle, 11/16" long | 263-658 | 11/16" | Cam Handle, 11/16" long |
| 263-654 | 1/2" | Cam Handle, 11/16" long | 263-660 | 7/8" | Cam Handle, 11/16" long |



PERMA-THREAD® HELICALLY COILED INSERTS PERMA-THREAD® PIÈCES FILETÉES DE RECHANGE



Repair defective, stripped or damaged threads quickly and permanently. These inserts are made of diamond shaped stainless steel wire formed into a spiral screw thread coil.

They form a thread which is stronger than the original tapped material. The resilient quality of the insert allows it to adjust to eliminate stress concentration. The Perma-Thread® insert restores the hole to its initial size - a bolt or screw of the original size can be used for reassembly.

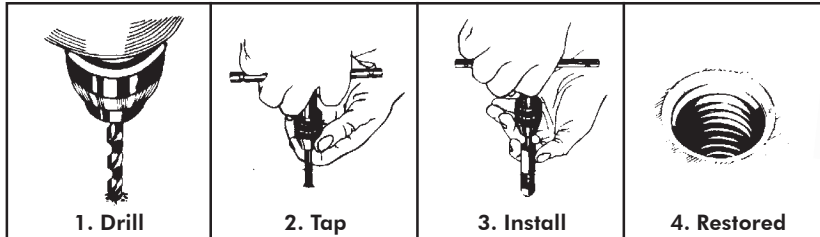

Full instructions for using the Perma-Thread® inserts are provided in each Repair Kit.



THREAD REPAIR MASTER ASST. No. 020-631

Includes contents of one Repair Kit of each 10-24, 1/4-20, 5/16-18, 3/8-16, 7/16-14, 1/2-13 and 14mm with 3/8", 7/16", 1/2" and 3/4" reach.



THREAD REPAIR CENTRE No. 1208-3

Stock the most popular Perma-Thread® inserts on this colourful, metal display. Five complete thread repair kits: 1/4-20, 5/16-18, 3/8-16, 7/16-14, 1/2-13 - plus five packs of inserts. Also one 14mm Spark Plug Kit (Tap and Tool) and three packs of plug inserts. Fourteen items plus rack.

METRIC THREAD REPAIR CENTRE No. 1212-3

Includes 4 Metric thread repair kits: M5x.8, M6x1.0, M8x1.25 and M10x1.5 - plus two Spark Plug Kits (Tap and Tool) for 12mm and 14mm plugs. Also four packs of plug inserts. Fourteen items plus rack.

PERMA-PLUG® 'PERMA-PLUG' SPARK PLUG REPAIR KIT No. 2200-14 TROUSSE DE REPARATION DE BOUGIE 'PERMA-PLUG'

INCLUDES ONE EACH OF THE ITEMS LISTED BELOW

Can be used with M14 x 1.25 taper seat or gasket type Spark Plugs in either aluminum or cast iron. Easily installed without drilling - becomes a permanent repair.



PILOTED TAP

2258-14

Tap
Lubricate tap. Start by hand then use socket to tap hole full depth. Clean chips from hole.



INSERTS

Short 2214-S Normal 2214-N Long 2214-L

Select Insert
Select insert length same as threads on spark plug. Coat outside threads with hi-temp RTV silicone. Knurled end of insert should be at top of hole.



Install

Using spark plug, screw insert in until flush with spark plug hole.



EXPANDING TOOL

2294-14



Repaired

Place tool into insert and strike several times to expand knurl and lock insert. Install plug to recommended torque. Run engine after sealant has set.



PERMA-PLUG
DISPLAY
CENTRE
No. 1400-1

Perma-Plug Display Centre No. 1400-1

| Contents and Replacement Parts | | |
|--------------------------------------|----------|-----|
| Description | Part No. | Qty |
| M14 x 1.25 Perma-Plug Kit | 2200-14 | 3 |
| M14 x 1.25 x 3/8 Short Reach Insert | 2214-S | 4 |
| M14 x 1.25 x 1/2 Normal Reach Insert | 2214-N | 4 |
| M14 x 1.25 x 3/4 Long Reach Insert | 2214-L | 4 |

Repair Kits contain inserts, tap and installation tools. Inserts also available in standard packages.
Order by Stock Number



Repair Kits

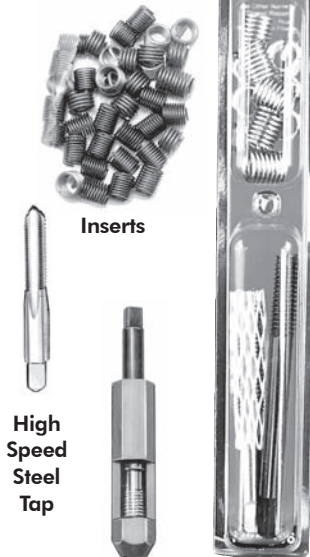

Inserts

High Speed Steel Tap

Installation Tool

Repair Kits for field or shop use.

Complete Kits: Inserts-taps-tools.

SPARK PLUG SERIES

COMBINATION PILOTED REAMER/TAP

No drilling for spark plug port repair

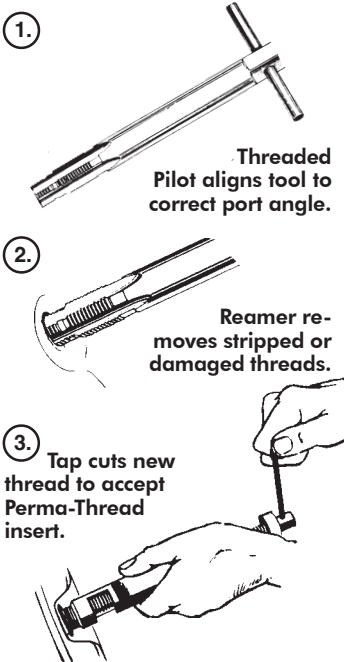

1. Threaded Pilot aligns tool to correct port angle.

2. Reamer removes stripped or damaged threads.

3. Tap cuts new thread to accept Perma-Thread insert.

| UNIFIED NATIONAL COARSE | | | | | | | | |
|---|------------|------------|----------|----|----------------------|---------|-------------|------------|
| STANDARD PACKAGES | | | | | REPAIR KITS | | TAPS | TOOLS |
| Size | Insert Pkg | Drill | Qty. | | Kit | Inserts | Tap | Tool |
| Dia. x Length | Part No. | Size | Per Pack | | Part No. | Per Kit | Part No. | Part No. |
| 4-40 | .168 | P208-014 | 1/8 | 12 | 1208-014 | 12 | 1428-014 | 1182-014 |
| 5-40 | .188 | P208-015 | 9/64 | 12 | 1208-015 | 12 | 1428-015 | 1182-015 |
| 6-32 | .207 | P208-016 | 5/32 | 12 | 1208-016 | 12 | 1428-016 | 1182-016 |
| 8-32 | .246 | P208-018 | 11/64 | 12 | 1208-018 | 12 | 1428-018 | 1182-018 |
| 10-24 | .285 | P208-101 | 13/64 | 12 | 1208-101 | 12 | 1428-101 | 1182-101 |
| 12-24 | .324 | P208-102 | 15/64 | 12 | 1208-102 | 12 | 1428-102 | 1182-102 |
| 1/4-20 | .375 | P208-104 | 17/64 | 12 | 1208-104 | 12 | 1428-104 | 1182-104 |
| 5/16-18 | .469 | P208-105 | 21/64 | 12 | 1208-105 | 12 | 1428-105 | 1182-105 |
| 3/8-16 | .562 | P208-106 | 25/64 | 12 | 1208-106 | 12 | 1428-106 | 1182-106 |
| 7/16-14 | .656 | P208-107 | 29/64 | 6 | 1208-107 | 6 | 1428-107 | 1182-107 |
| 1/2-13 | .750 | P208-108 | 17/32 | 6 | 1208-108 | 6 | 1428-108 | 1182-108 |
| 9/16-12 | .844 | P208-109 | 19/32 | 6 | 1208-109 | 6 | 1428-109 | 1182-109 |
| 5/8-11 | .938 | P208-110 | 21/32 | 6 | 1208-110 | 6 | 1428-110 | 1182-110 |
| 3/4-10 | 1.125 | P208-112 | 25/32 | 4 | 1208-112 | 4 | 1428-112 | 1182-112 |
| 7/8-9 | 1.312 | P108-114 | 29/32 | 1 | 3208-C14 | 6 | 1043-14CP3 | 1182-114 |
| 1-8 | 1.500 | P108-116 | 1-1/32 | 1 | 3208-C16 | 6 | 1043-16CP3 | 1182-116 |
| 1-1/8-7 | 1.688 | P108-118 | 1-5/32 | 1 | 3208-C18 | 5 | 1043-18CP3 | 1182-118 |
| 1-1/4-7 | 1.875 | P108-120 | 1-9/32 | 1 | 3208-C20 | 5 | 1043-20CP3 | 1182-120 |
| 1-3/8-6 | 2.062 | P108-122 | 1-13/32 | 1 | 3208-C22 | 4 | 1043-22CP3 | 1182-122 |
| 1-1/2-6 | 2.250 | P108-124 | 1-17/32 | 1 | 3208-C24 | 4 | 1043-24CP3 | 1182-124 |
| UNIFIED NATIONAL FINE | | | | | | | | |
| 10-32 | .285 | P208-201 | 13/64 | 12 | 1208-201 | 12 | 1428-201 | 1172-201 |
| 1/4-28 | .375 | P208-204 | 17/64 | 12 | 1208-204 | 12 | 1428-204 | 1172-204 |
| 5/16-24 | .469 | P208-205 | 21/64 | 12 | 1208-205 | 12 | 1428-205 | 1172-205 |
| 3/8-24 | .562 | P208-206 | 25/64 | 12 | 1208-206 | 12 | 1428-206 | 1172-206 |
| 7/16-20 | .656 | P208-207 | 29/64 | 6 | 1208-207 | 6 | 1428-207 | 1172-207 |
| 1/2-20 | .750 | P208-208 | 33/64 | 6 | 1208-208 | 6 | 1428-208 | 1172-208 |
| 9/16-18 | .844 | P208-209 | 37/64 | 6 | 1208-209 | 6 | 1428-209 | 1172-209 |
| 5/8-18 | .938 | P208-210 | 41/64 | 6 | 1208-210 | 6 | 1428-210 | 1172-210 |
| 3/4-16 | 1.125 | P208-212 | 49/64 | 4 | 1208-212 | 4 | 1428-212 | 1172-212 |
| 7/8-14 | 1.312 | P108-214 | 57/64 | 1 | 3208-F14 | 6 | 1043-14FP3 | 1039-14F |
| 1-14 | 1.500 | P108-2164 | 1-1/64 | 1 | 3208-F164 | 6 | 1043-164FP3 | 1039-164F |
| 1-1/8-12 | 1.688 | P108-218 | 1-5/32 | 1 | 3208-F18 | 5 | 1043-18FP3 | 1039-18F |
| 1-1/4-12 | 1.875 | P108-220 | 1-9/32 | 1 | 3208-F20 | 5 | 1043-20FP3 | 1039-20F |
| 1-3/8-12 | 2.062 | P108-222 | 1-13/32 | 1 | 3208-F22 | 4 | 1043-22FP3 | 1039-22F |
| 1-1/2-12 | 2.250 | P108-224 | 1-17/32 | 1 | 3208-F24 | 4 | 1043-24FP3 | 1039-24F |
| STANDARD METRIC SERIES | | | | | | | | |
| | | | | | Coarse Thread Series | | | |
| M5 x 0.8 | 7.5mm | P206-305 | 13/64 | 12 | 1221-305 | 12 | 1448-305 | 1287-305 |
| M6 x 1.0 | 9.0mm | P206-306 | 1/4 | 12 | 1221-306 | 12 | 1448-306 | 1287-306 |
| M7 x 1.0 | 10.5mm | P206-307 | 9/32 | 12 | 1221-307 | 12 | 1448-307 | 1289-307 |
| M8 x 1.25 | 12.0mm | P206-308 | 21/64 | 12 | 1221-308 | 12 | 1448-308 | 1289-308 |
| M9 x 1.25 | 13.5mm | P206-309 | m9.4 | 12 | 1221-309 | 12 | 1448-309 | 1289-309 |
| M10 x 1.5 | 15.0mm | P206-310 | 13/32 | 12 | 1221-310 | 12 | 1448-310 | 1289-310 |
| M11 x 1.5 | 16.5mm | P106-311 | 29/64 | 6 | 1221-311 | 6 | 1448-311 | 1289-311 |
| M12 x 1.7 | 18.0mm | P106-312 | 31/64 | 6 | 3221-M12C | 6 | 5043-120CP4 | 1289-312 |
| M14 x 2.0 | 21.0mm | P106-314 | 37/64 | 6 | 3221-M14C | 6 | 5043-140CP4 | 1289-314 |
| M16 x 2.0 | 24.0mm | P106-316 | 21/32 | 6 | 3221-M16C | 6 | 5043-160CP4 | 1289-316 |
| M18 x 2.5 | 27.0mm | P106-318 | 47/64 | 6 | 3221-M18C | 6 | 5043-180CP4 | 1289-318 |
| M20 x 2.5 | 30.0mm | P106-320 | 13/16 | 6 | 3221-M20C | 6 | 5043-200CP4 | 1289-320 |
| | | | | | Fine Thread Series | | | |
| M10 x 1.2 | 15.0mm | P106-610 | 13/32 | 6 | 3221-M10F | 6 | 5043-100FP4 | 1287-610 |
| M11 x 1.2 | 16.5mm | P106-61125 | 29/64 | 6 | 1221-M1125 | 6 | 1448-61125 | 1287-61125 |
| M12 x 1.2 | 18.0mm | P106-612 | 31/64 | 6 | 3221-M12F | 6 | 5043-120FP4 | 1287-612 |
| M12 x 1.5 | 18.0mm | P106-61215 | 31/64 | 6 | 3221-M1215 | 6 | 5043-1215P4 | 1287-61215 |
| M14 x 1.5 | 21.0mm | P106-614 | 9/16 | 6 | 3221-M14F | 6 | 5043-140FP4 | 1287-614 |
| M16 x 1.5 | 24.0mm | P106-616 | 21/32 | 6 | 3221-M16F | 6 | 5043-160FP4 | 1287-616 |
| SPARK PLUG SERIES | | | | | | | | |
| DO NOT USE THESE INSERTS TO REPAIR TAPER SEAT SPARK PLUG PORTS. | | | | | | | | |
| M10 x 1.0 | .500 | P410-500 | | 6 | 1210-410* | - | 1458-100 | 1094-100 |
| M12 x 1.2 | .500 | P412-500 | | 6 | 1212-412* | - | 1458-123 | 1094-123 |
| M12 x 1.2 | .750 | P412-750 | | 6 | - | - | - | - |
| M14 x 1.2 | .375 | P414-375 | | 6 | 1214-414* | - | 1458-143 | 1094-143 |
| M14 x 1.2 | .438 | P414-438 | | 6 | - | - | - | - |
| M14 x 1.2 | .500 | P414-500 | | 6 | - | - | - | - |
| M14 x 1.2 | .750 | P414-750 | | 6 | - | - | - | - |
| M18 x 1.5 | .500 | P418-500 | | 6 | 1218-500 | 6 | 1458-185 | 1094-185 |
| 'PERMA-PLUG' SPARK PLUG SERIES | | | | | | | | |
| CAN BE USED WITH TAPER SEAT OR GASKET TYPE SPARK PLUGS. | | | | | | | | |
| M14 x 1.2 | .375 | 2214S | | 1 | - | - | - | - |
| M14 x 1.2 | .500 | 2214N | | 1 | 2200-14 | - | 2258-14 | 2294-14 |
| M14 x 1.2 | .750 | 2214L | | 1 | - | - | - | - |

* NOTE: 10mm, 12mm and 14mm spark plug kits contain combination piloted Reamer/Tap tool and NO inserts. Same tools are applicable regardless of insert length. Purchase packs of inserts separately. 'Perma-Thread' Repair Kits include: Inserts, Tap, Installation Tool, Instructions unless otherwise specified.



904
Series

Papco VACUUM CONNECTORS RACCORDS DE PLASTIQUE

"Papco" Plastic Fittings are designed for quick, easy, inexpensive installations of vacuum lines, windshield washer lines and any other low pressure systems using air or fluids. Can be used with all flexible plastic tubing. Not recommended for fuel line applications.

Order by Stock Number



Nylon
STRAIGHT CONNECTOR

| Part No. | Tube Size | x | Tube Size |
|----------|-----------|---|-----------|
| 904-901 | 1/8 | x | 1/8 |
| 904-902 | 3/16 | x | 3/16 |
| 904-903 | 1/4 | x | 1/4 |
| 904-904 | 5/16 | x | 5/16 |
| 904-905 | 3/8 | x | 3/8 |



Nylon
REDUCING
STRAIGHT CONNECTOR

| Part No. | Tube Size | x | Tube Size |
|----------|-----------|---|-----------|
| 904-911 | 1/8 | x | 3/16 |
| 904-912 | 1/8 | x | 1/4 |
| 904-913 | 3/16 | x | 1/4 |
| 904-914 | 1/4 | x | 3/8 |



Nylon
RESTRICTOR CONNECTOR

| Part No. | Tube Size | x | Tube Size |
|----------|-----------|---|-----------|
| 904-920 | 3/16 | x | 3/16 |



Nylon
3 WAY TEE

| Part No. | Tube Size |
|----------|--------------------|
| 904-922 | 1/8 x 1/8 x 1/8 |
| 904-923 | 3/16 x 3/16 x 3/16 |
| 904-924 | 1/4 x 1/4 x 1/4 |
| 904-925 | 5/16 x 5/16 x 5/16 |
| 904-926 | 3/8 x 3/8 x 3/8 |



Nylon
3 WAY REDUCING TEE

| Part No. | Tube Size 'A' x 'B' x 'C' |
|----------|---------------------------|
| 904-929 | 1/8 x 1/8 x 3/16 |
| 904-930 | 1/8 x 1/8 x 1/4 |
| 904-931 | 3/16 x 1/8 x 3/16 |
| 904-932 | 3/16 x 1/4 x 3/16 |
| 904-933 | 3/16 x 3/16 x 1/8 |
| 904-934 | 1/4 x 3/16 x 3/16 |
| 904-938* | 1/4 x 3/8 x 3/8 |
| 904-939 | 3/8 x 3/8 x 1/4 |

*PCV Connector



Nylon
'Y' CONNECTOR

| Part No. | Tube Size |
|----------|--------------------|
| 904-940 | 1/8 x 1/8 x 1/8 |
| 904-941 | 3/16 x 3/16 x 3/16 |
| 904-942 | 1/4 x 1/4 x 1/4 |
| 904-943 | 5/16 x 5/16 x 5/16 |

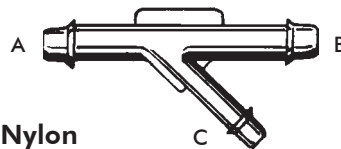

Nylon
REDUCING 'Y' CONNEC-

| Part No. | Tube Size 'A' x 'B' x 'C' |
|----------|---------------------------|
| 904-944 | 1/4 x 1/4 x 3/16 |

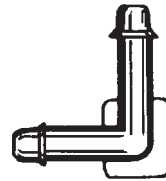

Nylon
90° ELBOW

| Part No. | Tube Size | x | Pipe Size |
|----------|-----------|---|-----------|
| 904-950 | 1/8 | x | 1/8 |
| 904-951 | 3/16 | x | 3/16 |
| 904-952 | 1/4 | x | 1/4 |
| 904-953 | 5/16 | x | 5/16 |

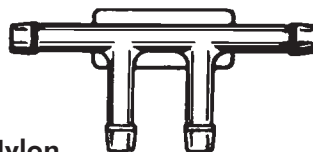

Nylon
FOUR WAY CONNECTOR

| Part No. | Tube Size |
|----------|-----------|
| 904-960 | 3/16 |



Nylon
FIVE WAY CONNECTOR

| Part No. | Tube Size |
|----------|-----------|
| 904-965 | 3/16 |

For 'Papco' Vacuum Connectors Master Assortment No. 020-605 see page 6.

Standard Package 25 Pieces

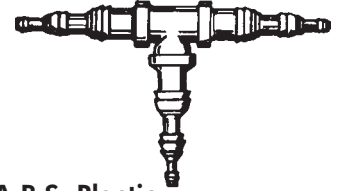

A.B.S. Plastic
UNIVERSAL TEE

| Part No. | Tube Size |
|----------|--------------------|
| 904-975 | 5/32 to 1/4 to 3/8 |



A.B.S. Plastic
UNIVERSAL STRAIGHT CONNECTOR

| Part No. | Tube Size |
|----------|--------------------|
| 904-976 | 5/32 to 1/4 to 3/8 |



VACUUM CAPS

| Part No. | Tube Size |
|----------|-----------|
| 904-990 | 1/8 |
| 904-991 | 3/16 |
| 904-992 | 1/4 |
| 904-993 | 5/16 |
| 904-994 | 3/8 |

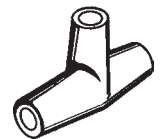

Soft Rubber
VACUUM TEE

| Part No. | Hose Size |
|----------|--------------------|
| 904-985 | 7/64 x 7/64 x 7/64 |

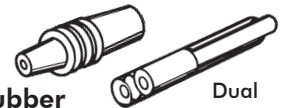

Soft Rubber
VACUUM CONNECTORS

| Part No. | Hose Size |
|----------|------------|
| 904-986 | 5/32 Dual |
| 904-987 | 1/8 x 5/32 |

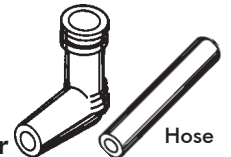

Soft Rubber
VACUUM ELBOW and HOSE

| Part No. | Hose Size |
|----------|----------------|
| 904-988 | 5/32 x 3/16 |
| 904-989 | 5/32 x 2" Hose |



papcoflex STEEL BRAKE LINE MERCHANDISERS PRESENTOIRS TUBULURE DE FREIN

"Papcoflex" Steel Brake Line floor merchandisers are available in 3 variations (see below) and may be linked together to form a master warehouse stock to cover almost every brake line requirement. Compact wire rack measures 9-1/2"w. x 20-1/2"d. x 28"h. and includes colour-coded, permanent PVC storage tubes for dispensing lines. Each "Papcoflex" Brake Line is labelled showing part number, O.D. and length - can be shaped by hand without crimping or collapsing.



STEEL BRAKE LINE MERCHANDISER No. 022-285

| Length | 3/16 O.D. Part No. | 1/4 O.D. Part No. | 5/16 O.D. Part No. | 3/8 O.D. Part No. |
|--------|-----------------------|----------------------|-----------------------|----------------------|
| 8" | S308 | S408 | S508 | *S610 |
| 12" | S312 | S412 | S512 | S612 |
| 20" | S320 | S420 | S520 | S620 |
| 30" | S330 | S430 | S530 | S630 |
| 40" | S340 | S440 | S540 | S640 |
| 51" | S351 | S451 | S551 | S651 |
| 60" | S360 | S460 | S560 | S660 |

Contains 3 each of 28 sizes of "Papcoflex" Brake Lines for a total of 84 lines. Rack and tubes included.

*10" Lines

ARMOURD BRAKE LINE MERCHANDISER No. 022-286

| Length | 3/16 O.D. Part No. | 1/4 O.D. Part No. | 5/16 O.D. Part No. | 3/8 O.D. Part No. |
|--------|-----------------------|----------------------|-----------------------|----------------------|
| 8" | AS308 | AS408 | AS508 | *AS610 |
| 12" | AS312 | AS412 | AS512 | AS612 |
| 20" | AS320 | AS420 | AS520 | AS620 |
| 30" | AS330 | AS430 | AS530 | AS630 |
| 40" | AS340 | AS440 | AS540 | AS640 |
| 51" | AS351 | AS451 | AS551 | AS651 |
| 60" | AS360 | AS460 | AS560 | AS660 |

Contains 3 each of 28 sizes of "Papcoflex" Armoured Steel Brake Lines for a total of 84 lines. Rack and tubes included.

*10" Lines

METRIC BRAKE LINE MERCHANDISER No. 022-287

| Length | Type A Japanese Part No. | Type B British Part No. | Type C European Part No. |
|--------|--------------------------------|-------------------------------|--------------------------------|
| 8" | MA308 | MB308 | MC308 |
| 12" | MA312 | MB312 | MC312 |
| 20" | MA320 | MB320 | MC320 |
| 30" | MA330 | MB330 | MC330 |
| 40" | MA340 | MB340 | MC340 |
| 51" | MA351 | MB351 | MC351 |
| 60" | MA360 | MB360 | MC360 |

Contains 3 each of 21 sizes of "Papcoflex" Metric Brake Lines for a total of 63 lines. Rack and tubes included.

papcoflex BRAKE LINE MERCHANDISERS

Each merchandiser includes a colourful metal rack with measuring gauge. Can be hung on a wall, shelf end or post. When joining two or more lines use 'Papco' Inverted Flare Unions.

No. 022-080

STEEL BRAKE LINE MERCHANDISERS

Contains 56 lengths of the most popular 3/16" and 1/4" diameter Steel Brake Lines. Four each of 3/16" and 1/4"x 8", 12", 20", 30", 40", 51" and 60".

No. 022-079

Contains 48 lengths of the most popular 5/16" and 3/8" diameter Steel Brake Lines. Four each of 5/16" and 3/8"x 12", 20", 30", 40", 51" and 60".

No. 022-081

ARMOURD STEEL BRAKE LINE MERCHANDISERS

Contains 56 lengths of the most popular 3/16" and 1/4" diameter Armoured Brake Lines. Four each of 3/16" and 1/4"x 8", 12", 20", 30", 40", 51" and 60".

No. 022-082

Contains 48 lengths of the most popular 5/16" and 3/8" diameter Armoured Brake Lines. Four each of 5/16" and 3/8"x 12", 20", 30", 40", 51" and 60".

METRIC BRAKE LINE MERCHANDISER

No. 022-083

Contains 42 lines - two each of the 21 listed lengths of Metric Brake Lines in Type 'A', 'B' and 'C'.

EMPTY BRAKE LINE RACKS

No. 022-077 For 3/16" and 1/4" dia. Brake Lines.
No. 022-078 For 5/16" and 3/8" dia. Brake Lines.
No. 022-078M For 3/16" dia. Metric Brake Lines.

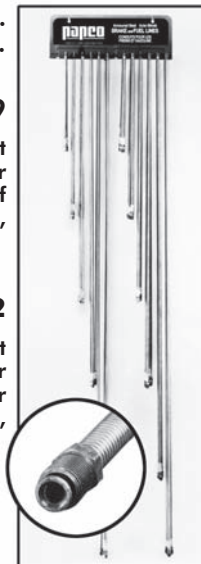

No. 022-284
Empty Wire Rack
(With tubes and colour-coded labels to create your own mix of lines)



papcoflex

**STEEL HYDRAULIC BRAKE LINES
TUBULURE DE FREIN ACIER**

STEEL BRAKE LINES

These ready to install "Papcoflex" Steel Hydraulic Brake Lines are required by every garage, service station, transmission specialist, fleet and farm equipment dealer. They are ideal replacements for hydraulic, gas, oil and vacuum lines used on all cars, trucks, buses and tractors. "Papcoflex" Lines are made of a single strip of copper coated steel, spiral wound for extra strength. This double-walled tube is then fused thereby providing a solid seamless, easy-to-bend tube. Tin coating is then applied to afford the highest degree of corrosion resistance. Flared fittings are included.



ARMoured STEEL BRAKE LINES

"Papcoflex" Armoured Steel Brake Lines feature the highest degree of protection against common road hazards. Each steel line is wound the entire length with a .046" diameter high carbon, galvanized wire and comes complete with flared fittings. Every line is O.E.M. approved and can be hand shaped to duplicate the original.



METRIC BRAKE LINES

All the proven features of the "Papcoflex" Steel Hydraulic Brake Line. Available in three types, all 3/16" diameter and in popular length as listed.

Type 'A': Metric Thread with standard flare. For Colt, Datsun, Honda, Mazda and Toyota.

Type 'B': U.S. Thread with bubble flare. For Austin, Cortina, Cricket, Fiat, Jaguar, M.G. and Triumph.

Type 'C': Metric Thread with bubble flare. For BMW, Citroen, Mercedes-Benz, Peugeot, Porsche, VW.

Order by Part Number

Standard Package contains 10 Lines

| Overall Length | 3/16" O.D. | | 1/4" O.D. | | 5/16" O.D. | | 3/8" O.D. | | METRIC 3/16" O.D. | | |
|----------------|------------|----------------|-----------|----------------|------------|----------------|-----------|----------------|-------------------|----------|----------|
| | Steel | Armoured Steel | Steel | Armoured Steel | Steel | Armoured Steel | Steel | Armoured Steel | Type 'A' | Type 'B' | Type 'C' |
| 6" | S306 | AS306 | - | - | - | - | - | - | - | - | - |
| 8" | S308 | AS308 | S408 | AS408 | S508 | AS508 | - | - | MA308 | MB308 | MC308 |
| 10" | S310 | AS310 | - | - | S510 | AS510 | S610 | AS610 | - | - | - |
| 12" | S312 | AS312 | S412 | AS412 | S512 | AS512 | S612 | AS612 | MA312 | MB312 | MC312 |
| 20" | S320 | AS320 | S420 | AS420 | S520 | AS520 | S620 | AS620 | MA320 | MB320 | MC320 |
| 30" | S330 | AS330 | S430 | AS430 | S530 | AS530 | S630 | AS630 | MA330 | MB330 | MC330 |
| 40" | S340 | AS340 | S440 | AS440 | S540 | AS540 | S640 | AS640 | MA340 | MB340 | MC340 |
| 51" | S351 | AS351 | S451 | AS451 | S551 | AS551 | S651 | AS651 | MA351 | MB351 | MC351 |
| 60" | S360 | AS360 | S460 | AS460 | S560 | AS560 | S660 | AS660 | MA360 | MB360 | MC360 |
| 72" | S372 | AS372 | S472 | AS472 | S572 | AS572 | S672 | AS672 | - | - | - |
| 108" | - | - | - | - | - | - | S6108 | AS6108 | - | - | - |
| Unions | 142-3 | | 142-4 | | 142-5 | | 142-6 | | PC1192 | PC1190 | PC1191 |

papco

**STEEL HYDRAULIC BRAKE LINES
TUBULURE DE FREIN ACIER**



ADAPTOR BRAKE LINES

"Papco" Adaptor Brake Lines allow for quick and easy connections of Steel Brake Lines to either the Master Cylinder or the Proportioning Valve. Eliminates having to make up your own lines with adaptors and steel tubing. All adaptor lines are 8" in length.

Order by Part Number

Individually Skin-Packed

| Card No. | Description |
|----------|--|
| 913-001 | 1/4" Inverted Brass Plated Nut - GM |
| 913-002 | 3/16" Inverted 1/4" Inverted Red Nut - AMC, Chrysler, Ford, GM |
| 913-003 | 3/16" Inverted to 5/16" Inverted Black Nut - Ford |
| 913-004 | 3/16" Inverted to 5/16" Inverted Green Nut - Ford, GM |
| 913-005 | 1/4" Inverted to 5/8-18 Blue Nut - GM |
| 913-006 | 3/16" Inverted to 5/8-18 Olive Nut - Ford |

papeo FUEL LINES TUYÈRE D'ESSENCE



'Papco' Fuel Lines are replacements for damaged, crimped or corroded lines from GM tank sending units or lines used with GM Fuel Filter No. 481. All lines come complete with Metric Flare Nut and a fuel rated 'O' Ring that ensures a reliable seal to the GM fuel filter. The 'bubble' end of the line is designed to provide an easy, leak-proof connection to the existing or replacement rubber fuel line. 5/16" lines have a M14x1.5 Nut and 3/8 lines have a M16x1.5 Nut.

Order by Stock Number

Individually Packaged

| 5/16" Diameter | | | | 3/8" Diameter | | | |
|----------------|-----------|-----------|-----------|---------------|----------|-----------|----------|
| Stock No. | Size | Stock No. | Size | Stock No. | Size | Stock No. | Size |
| 905-506 | 5/16 x 6 | 905-524 | 5/16 x 24 | 905-606 | 3/8 x 6 | 905-624 | 3/8 x 24 |
| 905-509 | 5/16 x 9 | 905-536 | 5/16 x 36 | 905-609 | 3/8 x 9 | 905-636 | 3/8 x 36 |
| 905-512 | 5/16 x 12 | 905-548 | 5/16 x 48 | 905-612 | 3/8 x 12 | 905-648 | 3/8 x 48 |
| 905-518 | 5/16 x 18 | | | 905-618 | 3/8 x 18 | | |

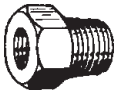

TRANSMISSION FITTINGS and BRAKE LINE ADAPTORS

| Stock No. | Inverted Seat | Male Thread |
|-----------|----------------|------------------|
| P7818 | 3/16 | 1/4 (7/16-14) |
| P7897 | 3/16 | 5/16 (1/2-20) |
| P7817 | 3/16 | (S)1/2-20* |
| P7909 | 3/16 | 1/2-20* |
| P7910 | 3/16 | 9/16-20* |
| P7911 | 3/16 | 9/16-18* |
| P7912 | 3/16 (9/16-18) | 1/2-20* |
| P7913 | 3/16 (1/2-20) | 9/16-18* |
| P7828 | 1/4 | (S)3/16 (3/8-24) |
| P7829 | 1/4 | 5/16 (1/2-20) |
| P7908 | 1/4 | 9/16-18* |
| P1074 | 5/16 | (S)1/2-20* |

* Special Thread

(S) Sealing Surface on hex face

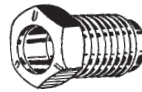

METRIC FLARE NUTS

| Stock No. | Size | Std. Pkg. |
|-----------|-----------|-----------|
| 905-101 | M14 x 1.5 | 5 |
| 905-104 | M16 x 1.5 | 5 |



FOREIGN CAR BRAKE LINE ADAPTORS

| Stock No. | Female | Male |
|-----------|--------------|----------|
| PC1176 | Tube 3/16 | 3/16 |
| Standard | Thrd. 3/8-24 | 10mmx1.0 |
| PC1177 | Tube 3/16 | 3/16 |
| Bubble | Thrd. 3/8-24 | 3/8-24 |
| PC1178 | Tube 3/16 | 3/16 |
| Bubble | Thrd. 3/8-24 | 10mmx1.0 |

INVERTED FLARE UNION

| Stock No. | Tube Size |
|-----------|-----------|
| 142-3 | 3/16 |
| 142-4 | 1/4 |
| 142-5 | 5/16 |
| 142-6 | 3/8 |

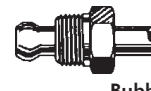

METRIC FLARE UNION Bubble Flare - U.S. and Metric Thread

| Stock No. | Female Bubble | Female Bubble |
|-----------|---------------------------|------------------|
| PC1190 | Tube 3/16 Thrd. 3/8-24 | 3/16 3/8-24 |
| PC1191 | Tube 3/16 10mmx1.0 | 3/16 10mmx1.0 |



Standard
Flare

METRIC FLARE UNION Standard Flare - Metric Thread

| Stock No. | Inverted Flare | Inverted Flare |
|-----------|-----------------------|------------------|
| PC1192 | Tube 3/16 10mmx1.0 | 3/16 10mmx1.0 |



Bubble

BRAKE LINE FLARE NUTS

| Stock No. | Size |
|-----------|-----------------------|
| MA300 | 10mmx1.0 SAE Flare |
| MC300 | 10mmx1.0 Bubble Flare |

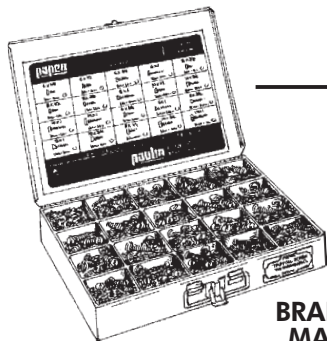

BRAKE BLEEDER SCREW MASTER ASSORTMENT No. 020-604

Contains 63 pieces of all listed Brake Bleeder Screws, Inverted Flare Nuts and Unions as well as Brake Line Adaptors and Metric Brake Line Flare Nuts.

papeo BRAKE BLEEDER SCREWS VIS DE PURGE DES FREINS

'Papco' Brake Bleeder Screws are made of zinc plated steel to resist rust. Replaces corroded, broken or stripped screws. Coverage for most domestic and import vehicles.



Type 1

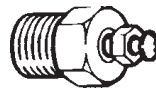

Type 2



Type 3

Order by Stock Number

Standard Package 5 Pieces

| Stock No. | Description | Type | Stock No. | Description | Type |
|-----------|-----------------------------------|------|-----------|-----------------------------------|------|
| 904-200 | 3/8-24 x 1.471 (Ford/Chrysler) | 1 | 904-209 | 7mm x 1.0 x 32mm (Domestic/Imp.) | 1 |
| 904-201 | 10mm x 1.5 x 28mm (GM) | 3 | 904-212 | 10mm x 1.0 x 33mm (Domestic/Imp.) | 1 |
| 904-203 | 3/8-24 x 1.110 (All Domestic) | 1 | 904-213 | 5/16-24 x 1.060 (GM/Chrysler) | 1 |
| 904-204 | 8mm x 1.25 x 33mm (GM/Honda) | 3 | 904-218 | Small Repair Insert | 2 |
| 904-206 | 1/4-28 x .920 (AMC/Ford/Chrysler) | 1 | 904-219 | Large Repair Insert | 2 |



Papco HYDRAULIC GREASE FITTINGS GRAISSEURS HYDRAULIQUES

"Papco" Hydraulic Grease Fittings are manufactured from high-quality, case hardened steel and are zinc plated to resist corrosion. Each fitting is heat treated and tested to 8,000 p.s.i. Spring-loaded ball check valve ensures a dirt-free lubrication system. "Papco" Grease Fittings are available in all popular thread types including thread-forming and metric.



Type 1
Straight



Type 2
30° Elbow



Type 3
45° Elbow



Type 4
65° Elbow



Type 5
90° Elbow



Type 6
Thread-Forming



Type 7
Straight Long

Order by Stock Number

Standard Package 25 Pieces

| Part No. | Type | Description | Part No. | Type | Description |
|----------|------|-----------------------|------------------------|------|-----------------------|
| 904-607 | 7 | 1/8 NPT Straight Long | 904-691 | 5 | 1/4-28 90° Elbow |
| 904-610 | 1 | 1/8 NPT Straight | 904-692 | 1 | 5/16-24 Straight |
| 904-611 | 2 | 1/8 NPT 30° Elbow | 904-693 | 1 | 3/8-24 Straight |
| 904-688 | 3 | 1/8 NPT 45° Elbow | 904-690 | 6 | 1/4-28 Thread-Forming |
| 904-612 | 4 | 1/8 NPT 65° Elbow | METRIC FITTINGS | | |
| 904-613 | 5 | 1/8 NPT 90° Elbow | 904-701 | 1 | 6mm x 1.0 Straight |
| 904-627 | 1 | 1/4 NPT Straight | 904-745 | 3 | 6mm x 1.0 45° Elbow |
| 904-629 | 4 | 1/4 NPT 65° Elbow | 904-790 | 5 | 6mm x 1.0 90° Elbow |
| 904-641 | 1 | 1/4-28 Straight | 904-702 | 1 | 8mm x 1.0 Straight |
| 904-652 | 7 | 1/4-28 Straight Long | 904-746 | 3 | 8mm x 1.0 45° Elbow |
| 904-636 | 3 | 1/4-28 45° Short | 904-791 | 5 | 8mm x 1.0 90° Elbow |
| 904-637 | 3 | 1/4-28 45° Long | 904-703 | 1 | 10mm x 1.0 Straight |



GREASE FITTINGS MASTER ASSORT.

No. 020-685

Contains 160 pieces of 17 popular sizes. Packed in a rigid all-metal lidded box.

GREASE FITTINGS ASSORTMENTS

No. 020-901 - Inch
No. 020-902 - Metric

Each assortment contains 100 Grease Fittings in six popular sizes.

| 020-901 Inch | | | | 020-902 Metric | | | |
|--------------|------|----------|------|----------------|------|----------|------|
| Part No. | Pcs. | Part No. | Pcs. | Part No. | Pcs. | Part No. | Pcs. |
| 904-641 | 60 | 904-691 | 6 | 904-701 | 40 | 904-745 | 10 |
| 904-610 | 20 | 904-688 | 4 | 904-702 | 20 | 904-746 | 10 |
| 904-637 | 6 | 904-613 | 4 | 904-703 | 10 | 904-790 | 10 |

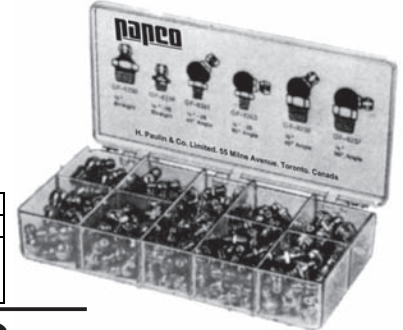

Papco COPPER TUBING TUYAU CUIVRE

Construction: Cold drawn to size, seamless and fully annealed alloy.

Advantages: Soft temper permits single and double flares as well as easy hand shaping.

Applications: Suitable for refrigeration, gasoline and oil lines on automobiles, trucks, marine and diesel engines, oil burners, water lines, industrial and general purpose use.

Available in 25*, 50 and 100 foot coils.

Order by Part Number

| Part Number | | | Outside Diam. | Wall Thick. | Weight per 100 ft. | W/P psi @100°F |
|-------------|---------|---------|---------------|-------------|--------------------|----------------|
| 25 ft. | 50 ft. | 100 ft. | | | | |
| 901-221 | 901-222 | 901-223 | 1/8" | .030" | 3.5 lbs. | 3130 |
| 901-231 | 901-232 | 901-233 | 3/16" | .030" | 5.8 lbs. | 1990 |
| 901-241 | 901-242 | 901-243 | 1/4" | .030" | 8.0 lbs. | 1450 |
| 901-251 | 901-252 | 901-253 | 5/16" | .032" | 11.0 lbs. | 1230 |
| 901-261 | 901-262 | 901-263 | 3/8" | .032" | 13.4 lbs. | 900 |
| 901-271 | 901-272 | 901-273 | 1/2" | .032" | 18.2 lbs. | 740 |
| 901-281 | 901-282 | 901-283 | 5/8" | .035" | 23.2 lbs. | 640 |
| 901-291 | 901-292 | 901-293 | 3/4" | .035" | 28.0 lbs. | 640 |

* Individually Packaged up to 3/8" O.D.

W/P - Working Pressure

Papco STEEL TUBING TUYAU ACIER

TIN COATED and ANNEALED
.028 Wall Thickness

"Papco" Steel Tubing is ideal for special automotive line replacements that require unusually short or long lengths of tubing. Provides a more economical means of installing hydraulic systems in automotive and truck applications. Standard coil length - 25 ft.

| Part No. | Tube Size O.D. |
|----------|----------------|
| 901-131 | 3/16 |
| 901-141 | 1/4 |
| 901-151 | 5/16 |
| 901-161 | 3/8 |





The Fastener System for the 'Walk-In' Trade

Turn everyday bolt-nut-screw sales into real profit makers.

- Rigid, reusable packages.
- Compact, space saver displays.
- Saves counterman's time.
- Display popular fasteners for self-serve customers.
- Novel package design - four vibrant colours.
- Label shows size, type, quantity and price code.

Pic-a-Pac dispensing racks can be used on gondolas, pylons or existing display space.

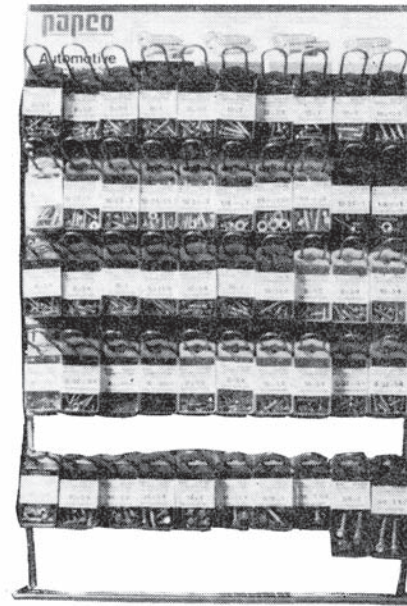

GRADE 5 FASTENERS MERCHANDISER No. 022-205

Includes Rack, Header Sign, Inventory Control Strips, Planogram and a 100 pac stock of the items listed below.

| Pac No. | Size | Pcs/Pac | Pac No. | Size | Pcs/Pac | Pac No. | Size | Pcs/Pac | Pac No. | Size | Pcs/Pac |
|------------------------|--------------|---------|------------------------|--------------|---------|------------------------|-------------|---------|--------------|------|---------|
| UNC Grade 5 Cap Screws | | | UNC Grade 5 Cap Screws | | | UNC Grade 5 Cap Screws | | | Flat Washers | | |
| 008-018 | 1/4 x 1/2 | 10 | 008-056 | 7/16 x 1 | 3 | 008-160 | 7/16 x 2 | 3 | 005-451 | 1/4 | 25 |
| 008-019 | 1/4 x 3/4 | 10 | 008-058 | 7/16 x 1-1/2 | 3 | 008-165 | 1/2 x 1-1/2 | 2 | 005-452 | 5/16 | 20 |
| 008-020 | 1/4 x 1 | 9 | 008-060 | 7/16 x 2 | 3 | 008-167 | 1/2 x 2 | 2 | 005-453 | 3/8 | 18 |
| 008-022 | 1/4 x 1-1/2 | 6 | 008-065 | 1/2 x 1-1/2 | 2 | UNC Hex Nuts | | | 005-454 | 7/16 | 10 |
| 008-024 | 1/4 x 2 | 4 | 008-067 | 1/2 x 2 | 2 | 005-651 | 1/4-20 | 15 | 005-455 | 1/2 | 8 |
| 008-031 | 5/16 x 3/4 | 7 | UNF Grade 5 Cap Screws | | | 005-652 | 5/16-18 | 12 | Lock Washers | | |
| 008-032 | 5/16 x 1 | 6 | 008-120 | 1/4 x 1 | 9 | 005-653 | 3/8-16 | 9 | 005-551 | 1/4 | 25 |
| 008-033 | 5/16 x 1-1/4 | 5 | 008-122 | 1/4 x 1-1/2 | 6 | 005-654 | 7/16-14 | 5 | 005-552 | 5/16 | 20 |
| 008-034 | 5/16 x 1-1/2 | 4 | 008-132 | 5/16 x 1 | 6 | 05-655 | 1/2-13 | 3 | 005-553 | 3/8 | 18 |
| 008-036 | 5/16 x 2 | 3 | 008-134 | 5/16 x 1-1/2 | 4 | UNF Hex Nuts | | | 005-554 | 7/16 | 10 |
| 008-044 | 3/8 x 1 | 6 | 008-146 | 3/8 x 1-1/2 | 4 | 005-671 | 1/4-28 | 15 | 005-555 | 1/2 | 8 |
| 008-046 | 3/8 x 1-1/2 | 4 | 008-148 | 3/8 x 2 | 4 | 005-672 | 5/16-24 | 12 | | | |
| 008-048 | 3/8 x 2 | 3 | 008-158 | 7/16 x 1-1/2 | 4 | 005-673 | 3/8-24 | 9 | | | |
| 008-049 | 3/8 x 2-1/2 | 3 | | | | 005-674 | 7/16-20 | 5 | | | |
| 008-050 | 3/8 x 3 | 2 | | | | 005-675 | 1/2-20 | 3 | | | |

AUTOMOTIVE TAPPING and MACHINE SCREWS MERCHANDISER No. 022-206

Includes Rack, Header Sign, Inventory Control Strips, Planogram and a 100 pac stock of the items listed below.

| Pac No. | Size | Pcs/Pac | Pac No. | Size | Pcs/Pac | Pac No. | Size | Pcs/Pac | Pac No. | Size | Pcs/Pac |
|--------------------------------|------------|---------|--------------------------------|--------------|---------|--|-----------------|---------|-------------------------------------|----------------|---------|
| Pan Slot Head Tapping Screws | | | Hex Washer Head Tapping Screws | | | Pan Phillips Head Tapping Screws | | | Round Slot Machine Screws with Nuts | | |
| 004-034 | 6 x 3/4 | 18 | 004-504 | 14 x 3/4 | 8 | 004-812 | 8 x 1/2 | 12 | 005-036 | 6-32 x 3/4 | 18 |
| 004-052 | 8 x 1/2 | 18 | 004-506 | 14 x 1 | 7 | 004-814 | 8 x 3/4 | 14 | 005-051 | 8-32 x 3/4 | 14 |
| 004-054 | 8 x 3/4 | 14 | 004-508 | 14 x 1-1/4 | 5 | 004-824 | 10 x 3/4 | 12 | 005-052 | 8-32 x 1 | 12 |
| 004-056 | 8 x 1/2 | 12 | 004-606 | 5/16 x 1 | 4 | 6-Lobe Drive Trim Screws | | | 005-054 | 8-32 x 1-1/2 | 10 |
| 004-080 | 10 x 3/4 | 12 | 004-608 | 5/16 x 1-1/4 | 3 | 004-835 | 4.2x20mm Chrome | 4 | 005-108 | 10-24 x 1 | 10 |
| 004-082 | 10 x 1 | 10 | 004-626 | 3/8 x 1 | 3 | 004-836 | 4.2x20mm Black | 4 | 005-110 | 10-24 x 1-1/2 | 10 |
| 004-092 | 12 x 3/4 | 14 | 004-630 | 3/8 x 1-1/2 | 2 | 004-839 | 4.2x30mm Chrome | 4 | 005-112 | 10-24 x 2 | 8 |
| 004-094 | 12 x 1 | 10 | Oval Phillips Small Head | | | 004-840 | 4.2x20mm Black | 4 | 005-128 | 1/4-20 x 1 | 8 |
| 004-106 | 14 x 1 | 9 | 004-734 | 6 x 3/4 | 16 | 'Drill-X' Self-Drilling/Tapping Screws | | | 005-130 | 1/4-20 x 1-1/2 | 7 |
| 004-108 | 14 x 1-1/2 | 7 | 004-754 | 8 x 3/4 | 12 | 004-882 | 8 x 1/2 Hex | 9 | 005-132 | 1/4-20 x 2 | 5 |
| Hex Washer Head Tapping Screws | | | 004-756 | 8 x 1 | 10 | 004-884 | 8 x 3/4 Hex | 7 | Flat Slot Machine Screws with Nuts | | |
| 004-478 | 10 x 1/2 | 14 | 004-757 | 8 x 1-1/4 | 8 | 004-892 | 10 x 1/2 Hex | 6 | 005-308 | 10-24 x 1 | 10 |
| 004-480 | 10 x 3/4 | 12 | 004-780 | 10 x 3/4 | 10 | 004-894 | 10 x 3/4 Hex | 5 | 005-328 | 1/4-20 x 1 | 8 |
| 004-502 | 14 x 1/2 | 10 | 004-782 | 10 x 1 | 9 | | | | | | |
| | | | 004-784 | 10 x 1-1/2 | 8 | | | | | | |



pie-a-pac[®] MERCHANDISERS PRESENTOIRS

TRIM SCREW MERCHANDISER No. 022-207

Includes 50 peg Rack, Header Sign, Inventory Control Strips, Planogram and a 100 pac stock of the items listed below.

| Pac No. | Cat No. | Size | Pcs/Pac | Pac No. | Cat No. | Size | Pcs/Pac | Pac No. | Cat No. | Size | Pcs/Pac | Pac No. | Cat No. | Size | Pcs/Pac |
|-------------------------------|---------|-----------|---------|-----------------------------|---------|-----------|---------|--------------------------------------|---------|---------------|---------|--------------------------------------|---------|----------------|---------|
| Washer Head Trim Screws-Black | | | | Oval Head Sems-Chrome | | | | Oval Head Trim Screws-Black | | | | 'Drill-X' Self-Drilling/Tapping Sems | | | |
| 004-901 | 229-401 | 8 x 1/2 | 10 | 004-947 | 229-837 | 10 x 1 | 3 | 004-433 | 229-933 | 10 x 3/4 | 6 | 004-988 | 229-988 | 8 x 1 Black | 3 |
| 004-902 | 229-402 | 8 x 5/8 | 9 | Oval Head Sems-Black | | | | 004-437 | 229-937 | 10 x 1 | 5 | Metric Trim Screws-Chrome | | | |
| 004-903 | 229-403 | 8 x 3/4 | 8 | 004-949 | 229-849 | 8 x 5/8 | 7 | 004-445 | 229-945 | 10 x 1-1/2 | 4 | 004-466 | 230-203 | 4.2 x 13 Pan | 7 |
| 004-905 | 229-405 | 8 x 1/2 | 8 | 004-951 | 229-851 | 8 x 3/4 | 7 | Pan Head Trim Screws- Black | | | | 004-467 | 230-205 | 4.2 x 20 Pan | 6 |
| 004-907 | 229-407 | 8 x 1-1/4 | 5 | 004-955 | 229-855 | 8 x 1 | 6 | 004-450 | 229-960 | 6 x 1/2 | 14 | 004-468 | 230-206 | 4.2 x 20 Pan | 3 |
| 004-914 | 229-414 | 10 x 3/4 | 7 | 004-973 | 229-883 | 10 x 3/4 | 4 | 004-455 | 229-962 | 8 x 1/2 | 11 | 004-469 | 230-207 | 4.2 x 20 Oval | 6 |
| 004-916 | 229-416 | 10 x 1 | 6 | 004-977 | 229-887 | 10 x 1 | 4 | 004-456 | 229-968 | 8 x 3/4 | 10 | Metric Washer Head Trim Screws | | | |
| Oval Head Sems-Chrome | | | | Oval Head Trim Screws-Black | | | | 004-457 | 229-972 | 8 x 1/2 | 8 | 004-470 | 230-301 | 4.2 x 8 Chr. | 7 |
| 004-920 | 229-806 | 6 x 3/4 | 5 | 004-411 | 229-911 | 8 x 3/4 | 6 | 004-460 | 229-980 | 10 x 3/4 | 8 | 004-471* | 230-302 | 4.2 x 12 Chr. | 7 |
| 004-925 | 229-811 | 8 x 3/4 | 5 | 004-412 | 229-912 | 8 x 3/4 | 6 | 004-461 | 229-982 | 10 x 1 | 7 | 004-472* | 230-303 | 4.2 x 12 Black | 7 |
| 004-929 | 229-815 | 8 x 1 | 4 | 004-415 | 229-915 | 8 x 1 | 6 | 'Drill-X' Self-Drilling/Tapping Sems | | | | 004-473 | 230-304 | 4.2 x 16 Chr. | 6 |
| 004-933 | 229-819 | 8 x 1-1/4 | 4 | 004-416 | 229-916 | 8 x 1 | 6 | 004-985 | 229-985 | 8 x 3/4 Chr. | 3 | 004-474 | 230-305 | 4.2 x 20 Chr. | 6 |
| 004-943 | 229-833 | 10 x 3/4 | 4 | 004-419 | 229-919 | 8 x 1-1/4 | 6 | 004-986 | 229-986 | 8 x 1 Chrome | 3 | 004-475* | 230-306 | 4.2 x 20 Black | 6 |
| | | | | 004-423 | 229-923 | 8 x 1-1/2 | 5 | 004-987 | 229-987 | 8 x 3/4 Black | 4 | * Indicates items double-pegged. | | | |

METRIC FASTENERS MERCHANDISER No. 022-210

Includes Rack, Header Sign, Inventory Control Strips, Planogram and a 100 pac stock of the items listed below.

| Pac No. | Size | Pcs/Pac | Pac No. | Size | Pcs/Pac | Pac No. | Size | Pcs/Pac | Pac No. | Size | Pcs/Pac |
|-----------------------------------|-------|---------|-----------------------------------|--------|---------|---|-------------|---------|---------------------|------|---------|
| Metric Cap Screws - Coarse Thread | | | Metric Cap Screws - Coarse Thread | | | Metric Hex Nuts - Coarse Thread | | | Metric Flat Washers | | |
| 002-025 | M4x16 | 10 | 002-055 | M8x40 | 2 | 002-090 | M7 | 10 | 002-101 | 4mm | 20 |
| 002-027 | M5x12 | 10 | 002-057 | M8x50 | 2 | 002-094 | M8 | 7 | 002-102 | 5mm | 18 |
| 002-031 | M5x25 | 7 | 002-058 | M8x70 | 1 | 002-095 | M10 | 7 | 002-103 | 6mm | 15 |
| 002-033 | M6x12 | 9 | 002-060 | M10x20 | 2 | 002-096 | M12 | 5 | 002-100 | 7mm | 14 |
| 002-035 | M6x16 | 8 | 002-063 | M10x30 | 2 | Metric Cap Screws with Nuts Fine and Extra Fine Thread | | | 002-104 | 8mm | 12 |
| 002-037 | M6x20 | 7 | 002-065 | M10x40 | 1 | 002-210 | M8x1.0x40 | 2 | 002-105 | 10mm | 8 |
| 002-039 | M6x25 | 7 | 002-067 | M10x50 | 1 | 002-222 | M10x1.0x50 | 1 | 002-106 | 12mm | 6 |
| 002-040 | M6x30 | 6 | 002-069 | M10x70 | 1 | 002-223 | M10x1.25x50 | 1 | Metric Lock Washers | | |
| 002-043 | M6x45 | 4 | 002-013 | M12x35 | 1 | 002-242 | M12x1.5x50 | 1 | 002-080 | 5mm | 30 |
| 002-045 | M7x20 | 5 | 002-016 | M12x50 | 1 | 002-243 | M12x1.25x50 | 1 | 002-081 | 6mm | 25 |
| 002-048 | M8x16 | 5 | 002-018 | M12x70 | 1 | Metric Hex Nuts - Coarse Thread | | | 002-079 | 7mm | 20 |
| 002-050 | M8x20 | 4 | | | | 002-091 | M4 | 16 | 002-082 | 8mm | 18 |
| 002-052 | M8x25 | 3 | | | | 002-092 | M5 | 14 | 002-083 | 10mm | 18 |
| 002-053 | M8x30 | 3 | | | | 002-093 | M6 | 12 | 002-084 | 12mm | 15 |

BODY BOLT and NUT MERCHANDISER No. 022-215

Includes 50 peg Rack, Header Sign, Inventory Control Strips, Planogram and a 100 pac stock of the items listed below.

| Pac No. | Cat No. | Size | Pcs/Pac | Pac No. | Cat No. | Size | Pcs/Pac | Pac No. | Cat No. | Size | Pcs/Pac | Pac No. | Cat No. | Size | Pcs/Pac |
|------------------------|---------|---------|---------|----------------------------|---------|------------|---------|------------|---------|---------|---------|------------------|---------|----------------|---------|
| Multi-Thread 'U' Nuts | | | | Metric 'U' Nuts | | | | Body Bolts | | | | Body Bolts | | | |
| 006-214 | 240-614 | 1/4-20 | 3 | 006-229 | 241-608 | M8 | 2 | 006-122 | 245-322 | M6x22 | 1 | 006-170 | 245-610 | Mirr. Bolt&Nut | 1 |
| 006-215 | 240-615 | 1/4-20 | 2 | 006-230 | 241-609 | M8 | 2 | 006-125 | 245-325 | M6x30 | 1 | 006-175 | 245-615 | 5/16 x 7/8 | 3 |
| 006-216 | 240-616 | 5/16-18 | 3 | 006-232 | 241-610 | M10 | 1 | 006-130 | 245-400 | M4.2x20 | 3 | 006-176 | 245-616 | 5/16 x 1 | 2 |
| 006-217 | 240-617 | 5/16-18 | 2 | 006-228 | 241-612 | M6.3 | 2 | 006-135 | 245-405 | M6x20 | 2 | 006-180 | 245-620 | 3/8 x 1 | 1 |
| 006-218 | 240-618 | 3/8-16 | 1 | Metric Lock Nuts | | | | 006-137 | 245-407 | M6x25 | 2 | 006-182 | 245-630 | 3/8 x 1-1/2 | 1 |
| 006-219 | 240-619 | 3/8-16 | 1 | 006-256 | 244-956 | M6 | 2 | 006-138 | 245-408 | M6x25 | 2 | Bumper Bar Bolts | | | |
| 006-246 | 240-706 | No. 6 | 4 | 006-257 | 244-957 | M6 | 2 | 006-140 | 245-420 | M6.3x20 | 2 | 008-712 | 245-167 | 3/8 x 1-1/4 | 1 |
| Single Thread 'U' Nuts | | | | 006-258 | 244-958 | M6.3 | 2 | 006-144 | 245-424 | M6.3x25 | 2 | 008-714 | 245-172 | 7/16 x 1-1/4 | 1 |
| 006-248 | 240-708 | No. 8 | 4 | 006-267 | 244-987 | M8 | 2 | 006-145 | 245-425 | M6.3x25 | 2 | 008-715 | 245-173 | 7/16 x 1-1/2 | 1 |
| 006-249 | 240-709 | No. 8 | 4 | 006-268 | 244-988 | M10 | 2 | 006-150 | 245-440 | M8x30 | 2 | 008-718 | 245-183 | 1/2 x 1-1/2 | 1 |
| 006-250 | 240-710 | No. 10 | 2 | Mirror Mounting Nuts | | | | 006-155 | 245-505 | M6x20 | 4 | 008-725 | 245-220 | M8x20 | 1 |
| 006-254 | 240-714 | No. 14 | 2 | 006-291 | 239-991 | 1/4-20 | 12 | 006-157 | 245-507 | M6x25 | 4 | | | | |
| Metric 'U' Nuts | | | | 006-296 | 239-960 | 1/4-20 | 2 | 006-160 | 245-510 | M6x35 | 2 | | | | |
| 006-226 | 241-606 | M6 | 3 | Licence Plate Bolts & Nuts | | | | 006-165 | 245-525 | M8x25 | 2 | | | | |
| 006-227 | 241-607 | M6 | 2 | 006-109 | 245-906 | Lic. Bolts | 4 | 006-167 | 245-527 | M8x30 | 2 | | | | |

BOLT RETAINER, SPEEDNUT, 'PALNUT' and RIVET MERCHANDISER No. 022-216

Includes 50 peg Rack, Header Sign, Inventory Control Strips, Planogram and a 100 pac stock of the items listed below.

| Pac No. | Cat No. | Size | Pcs/Pac | Pac No. | Cat No. | Size | Pcs/Pac | Pac No. | Cat No. | Size | Pcs/Pac | Pac No. | Cat No. | Size | Pcs/Pac |
|-----------------------|---------|------|---------|-----------------------|---------|-------------|---------|---------------------------------|---------|--------------|---------|---------------|---------|---------------|---------|
| Self-Threading Nuts | | | | Metric Bolt Retainers | | | | Speed Nuts | | | | Door Bushings | | | |
| 006-350 | 242-206 | 1/8 | 13 | 006-382 | 243-308 | M8 | 8 | 008-317 | 240-267 | No. 14 'U' | 3 | 006-394 | 250-553 | GM Splinned | 2 |
| 006-352 | 242-210 | 3/16 | 12 | 006-383 | 243-310 | M10 | 6 | 008-320 | 240-335 | 1/8 Flat | 9 | Rivets | | | |
| 006-358 | 242-214 | 1/4 | 9 | 006-384 | 243-312 | M12 | 5 | 008-321 | 240-350 | 3/16 Flat | 7 | 008-657 | 239-211 | 1/8x1/8 Steel | 30 |
| 006-354 | 242-216 | 5/16 | 3 | Weld Pins | | | | 008-325 | 240-405 | 1/16 Tubular | 3 | 008-666 | 239-216 | 1/8x1/4 Steel | 20 |
| Bolt Retainers | | | | 006-490 | 239-900 | 2mm | 30 | 008-326 | 240-410 | 3/32 Tubular | 3 | 008-603 | 239-017 | 1/8x1/4 Alu. | 27 |
| 006-360 | 242-314 | 1/4 | 10 | 006-491 | 239-901 | 25mm | 30 | 008-327* | 240-430 | 1/8 Tubular | 4 | 008-612 | 239-026 | 1/8x1/2 Alu. | 20 |
| 006-361 | 242-316 | 5/16 | 9 | Assorted Push Nuts | | | | 008-328 | 240-431 | 1/8 Tubular | 4 | 008-618 | 239-053 | 3/16x1/4 Alu. | 12 |
| 006-362 | 242-318 | 3/8 | 9 | 006-106 | - | Ass'd | 7 | 008-329 | 240-450 | 5-32 Tubular | 3 | 008-690 | 239-257 | 3/16x3/8 Ste. | 10 |
| 006-364 | 242-322 | 1/2 | 8 | Speed Nuts | | | | 008-340 | 240-471 | 3/16 Tubular | 3 | 008-627 | 239-059 | 3/16x1/2 Alu. | 12 |
| Push-on Nuts | | | | 008-305 | 240-120 | 10-24 Flat | 7 | Door Bushings | | | | Backup Plates | | | |
| 006-370 | 242-406 | 1/8 | 14 | 008-306 | 240-160 | 1/4-20 Flat | 6 | 006-390 | 250-549 | GM | 2 | 008-698 | 239-493 | 1/8 Steel | 24 |
| 006-371 | 242-410 | 3/16 | 13 | 008-312 | 240-228 | No. 8 'U' | 3 | 006-391 | 250-550 | GM, Ford | 2 | 008-699 | 239-494 | 3/16 Steel | 24 |
| 006-372 | 242-414 | 1/4 | 12 | 008-313 | 240-230 | No. 8 'U' | 3 | 006-392 | 250-551 | Ford | 2 | | | | |
| Metric Bolt Retainers | | | | 008-314 | 240-243 | 10-24 'U' | 3 | 006-393 | 250-552 | Chrysler | 2 | | | | |
| 006-380 | 243-306 | M6 | 11 | 008-315 | 240-248 | No. 10 'U' | 3 | * Indicates Item double-pegged. | | | | | | | |
| 006-381 | 243-307 | M6.3 | 11 | 008-316 | 240-263 | 1/4-20 'U' | 3 | | | | | | | | |

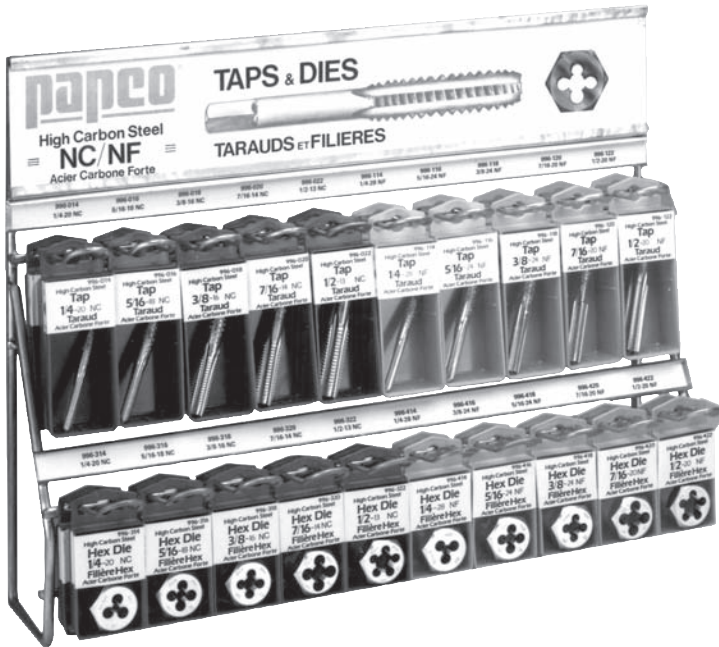

**Merchandisers No. 022-108, 109 and 110
(see next page)**

**Plug
Tap**

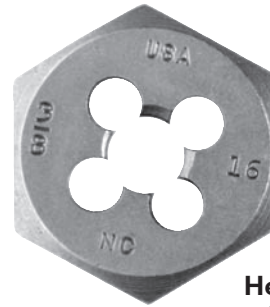

**Hex
Die**



'PAPCO' TAPS and DIES

'Papco' Taps and Dies are made of high carbon tool steel, heat treated to industrial specifications and packed in colour-coded, protective packs. Long-life, plug type taps are chamfered for easy starting and cut clean accurate threads. Hexagon dies in sizes to 1/2" and M12 are 1" across flats - larger sizes are 1-7/16" across flats. Use Die Stock No. 996-563 or wrench for driving dies. 'Papco' Taps and Dies are available in NC (National Coarse), NF (National Fine); Metric Standard, Fine and Extra Fine thread pitch - plus N.P.T. (National Pipe Thread) and B.S.P. (British Standard Pipe) for fittings on Import vehicles. Tap and drill sizes are engraved on each tap - starting side and size engraved on dies.

| 'Papco' HIGH CARBON STEEL, PLUG TYPE TAPS - Individually Packaged | | | | | | | | | | | |
|--|---------|-------|------------------|---------|-------|----------|-----------|-------|----------|-----------|-------|
| NC National Coarse | | | NF National Fine | | | Metric | | | Pipe | | |
| Part No. | Size | Drill | Part No. | Size | Drill | Part No. | Size | Drill | Part No. | Size | Drill |
| 996-006 | 6-32 | 7/64 | | | | 996-204 | M4x.7 | 1/8 | 996-250 | 1/8-27NPT | 11/32 |
| 996-008 | 8-32 | 9/64 | | | | 996-205 | M5x.8 | 11/64 | 996-252 | 1/4-18NPT | 7/16 |
| 996-010 | 10-24 | 5/32 | 996-110 | 10-32 | 5/32 | 996-206 | M6x1.0 | 13/64 | 996-254 | 3/8-18NPT | 37/64 |
| 996-014 | 1/4-20 | 13/64 | 996-114 | 1/4-28 | 7/32 | 996-208 | M8x1.25 | 17/64 | 996-256 | 1/2-14NPT | 23/32 |
| 996-016 | 5/16-18 | 17/64 | 996-116 | 5/16-24 | 17/64 | 996-210 | M10x1.5 | 11/32 | 996-257 | 1/8-28BS | 5/16 |
| 996-018 | 3/8-16 | 5/16 | 996-118 | 3/8-24 | 21/64 | 996-212 | M12x1.75 | 27/64 | | | |
| 996-020 | 7/16-14 | 3/8 | 996-120 | 7/16-20 | 25/64 | 996-230 | M8x1.0F | 9/32 | | | |
| 996-022 | 1/2-13 | 27/64 | 996-122 | 1/2-20 | 29/64 | 996-231 | M10x1.25F | 11/32 | | | |
| 996-023 | 9/16-12 | 31/64 | 996-123 | 9/16-18 | 33/64 | 996-232 | M12x1.5F | 13/32 | | | |
| 996-024 | 5/8-11 | 17/32 | 996-124 | 5/8-18 | 37/64 | 996-240 | M10x1.0XF | 23/64 | | | |
| 996-026 | 3/4-10 | 21/32 | 996-126 | 3/4-16 | 11/16 | | | | | | |

F - Fine Thread Pitch
XF - Extra Fine Thread
(Spark Plug)

| 'Papco' HIGH CARBON STEEL, HEXAGON DIES (1" AF) - Individually Packaged | | | | | | | |
|--|---------|------------------|---------|----------|-------------|----------|-----------------------|
| NC National Coarse | | NF National Fine | | Metric | | Pipe | |
| Part No. | Size | Part No. | Size | Part No. | Size | Part No. | Size |
| 996-314 | 1/4-20 | 996-414 | 1/4-28 | 996-504 | M4x.7 | 996-540 | 1/8-27 NPT |
| 996-316 | 5/16-18 | 996-416 | 5/16-24 | 996-505 | M5x.8 | 996-541 | 1/4-18 NPT |
| 996-318 | 3/8-16 | 996-418 | 3/8-24 | 996-506 | M6x1.0 | 996-547 | 1/8-28BS |
| 996-320 | 7/16-14 | 996-420 | 7/16-20 | 996-508 | M8x1.25 | | |
| 996-322 | 1/2-13 | 996-422 | 1/2-20 | 996-510 | M10x1.5 | | |
| 996-323* | 9/16-12 | 996-423* | 9/16-18 | 996-512 | M12x1.75 | | |
| 996-324* | 5/8-11 | 996-424* | 5/8-18 | 996-530 | M8x1.0 F | | |
| 996-326* | 3/4-10 | 996-426* | 3/4-16 | 996-531 | M10x1.25 XF | | (* 1-7/16" AF) |
| | | | | 996-532 | M12x1.5 F | | F - Fine Thread Pitch |



papeo® THREAD CUTTING TOOLS and MERCHANDISERS PRÉSENTOIRS et OUTILS AUTO-TARAUDEUSES

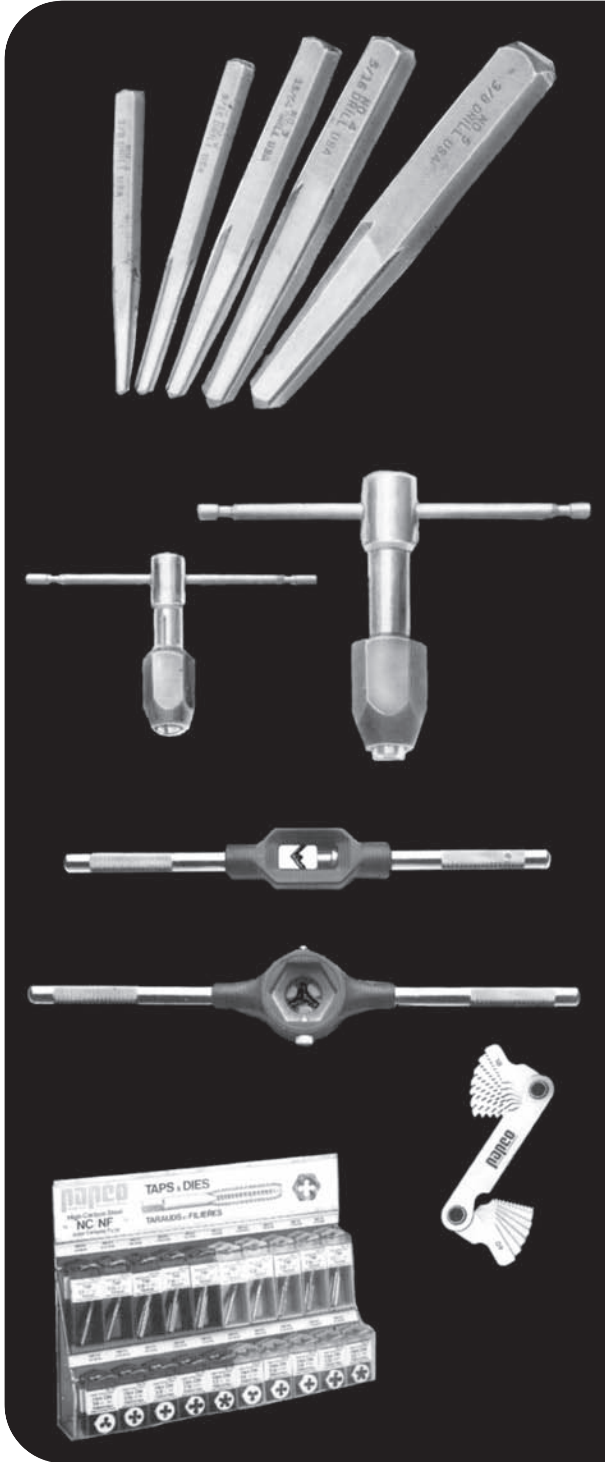

'A' SCREW EXTRACTORS

These chrome-vanadium straight flute extractors are heat treated to give the highest torque specification and may be used with any wrench. Straight tapered flute will not expand the screw or stud being removed. Drill size engraved on each individually packed extractor.

| Part No. | Size | Fits Screw Dia. | Use Drill |
|----------|--------|--------------------------|-----------|
| 996-551 | No. 1 | 1/4, 5/16, M6, M8 | 1/8 |
| 996-552 | No. 2 | 3/8, M10, 1/8-27, 1/8-28 | 3/16 |
| 996-553 | No. 3* | 7/16, M12 | 15/64 |
| 996-554 | No. 4 | 1/2, 9/16, M14, 1/4-18 | 5/16 |
| 996-555 | No. 5 | 5/8, M16, 3/8-18 | 3/8 |

*Use for broken Grease Fittings

SCREW EXTRACTOR SET No. 996-550

Consists of five extractors - One each of No. 1 to 5 as listed above.

TOOLS

'B' 'T' - HANDLE TAP WRENCH No. 996-560

Fits taps from No. 0 to 1/4" and features adjustable, self-equalizing wrench jaws. Handle is held in place by spring tension. Individually carded.

'C' 'T' - HANDLE TAP WRENCH No. 996-561

Fits 1/4" to 1/2" taps. Features a removable handle-plus a 3/8" female square drive for extensions or ratchet drive. Individually carded.

'D' PROFESSIONAL TAP WRENCH No. 996-562

Fits taps from M4 to 1/2". Industrial quality tool is used for taps, reamers and screw extractors. Adjustable, hardened jaws tighten by turning handles. Individually carded.

'E' DIE STOCK No. 996-563

Professional Die Holder fits 1" hexagon or round dies up to 1/2" or M12. Has three jaw, self-centering, adjustable guides for easy starting and accurate threading. Chrome plated handles. Individually carded.

'F' SCREW PITCH GAUGES

INCH SCREW PITCH GAUGE No. 996-570

For inch threads. 14 blades for threads from 10 to 40 per inch. Individually packaged. (Inch 'pitch' is the number of threads per inch T.P.I.)

METRIC SCREW PITCH GAUGE No. 996-571

For metric threads. 14 blades for pitches from 0.45 to 2.50mm. Individually packaged. (Metric 'pitch' is the distance between threads.)

NC/NF MERCHANDISER No. 022-108 (as illustrated)

Contains one each of 1/4 to 1/2 Coarse and Fine Thread Taps and Dies - 20 sizes. Includes wire rack, header sign and label strips.

METRIC MERCHANDISER No. 022-109

Contains one each of all listed sizes of Metric Standard, Fine and Extra Fine thread pitch Taps and Dies - 19 sizes. Includes wire rack, header sign and label strips.

MERCHANDISER No. 022-110

Contains one each of NPT and BSP Taps and Dies, No. 1 to 5 Screw Extractors, Screw Extractor Set, Inch and Metric Thread Pitch Gauges and a professional Tap and Reamer Wrench. Includes pegboard hooks, header sign and planogram.

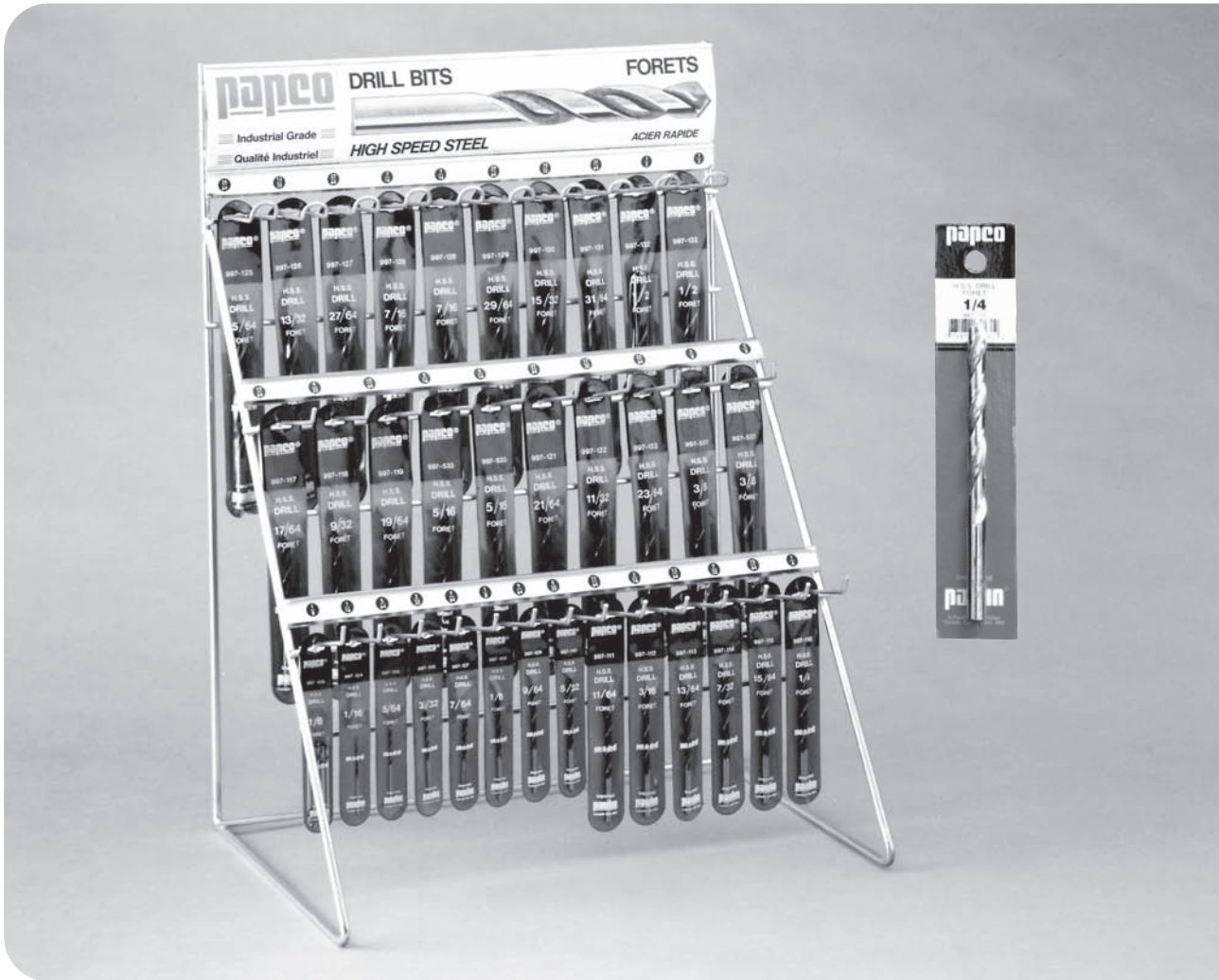

These jobber length high speed tool steel drill bits feature a ground body and polished flutes for fast chip removal. Suitable for drilling steel, wood and plastic. Bits are individually (* 2 bits) packaged on bar-coded hang-up cards. Order by Stock No.

| Stock No. | Diameter | Length Overall | Stock No. | Diameter | Length Overall | Stock No. | Diameter | Length Overall |
|--------------------------------|----------|----------------|---|----------|----------------|---|----------|----------------|
| HIGH SPEED STEEL DRILLS | | | HIGH SPEED STEEL DRILLS (cont'd) | | | HIGH SPEED STEEL DRILLS (cont'd) | | |
| 997-104* | 1/16" | 1-7/8" | 997-117 | 17/64" | 4-1/8" | 997-130† | 15/32" | 5-3/4" |
| 997-105* | 5/64 | 2 | 997-118 | 9/32 | 4-1/4 | 997-131† | 31/64 | 5-7/8 |
| 997-106* | 3/32 | 2-1/4 | 997-119 | 19/64 | 4-3/8 | 997-132† | 1/2 | 6 |
| 997-107* | 7/64 | 2-5/8 | 997-120 | 5/16 | 4-1/2 | MASONRY DRILLS - Carbide Tip | | |
| 997-108* | 1/8 | 2-3/4 | 997-121 | 21/64 | 4-5/8 | 997-586 | 3/16" | 3-3/8" |
| 997-109 | 9/64 | 2-7/8 | 997-122 | 11/32 | 4-3/4 | 997-587 | 1/4 | 4 |
| 997-110 | 5/32 | 3-1/8 | 997-123 | 23/64 | 4-7/8 | 997-588 | 5/16 | 4-3/4 |
| 997-111 | 11/64 | 3-1/4 | 997-124 | 3/8 | 5 | 997-589 | 3/8 | 4-3/4 |
| 997-112 | 3/16 | 3-1/2 | 997-125† | 25/64 | 5-1/8 | 997-590† | 1/2 | 5-7/8 |
| 997-113 | 13/64 | 3-5/8 | 997-126† | 13/32 | 5-1/4 | 997-591† | 5/8 | 6 |
| 997-114 | 7/32 | 3-3/4 | 997-127† | 27/64 | 5-3/8 | 997-592† | 3/4 | 6 |
| 997-115 | 15/64 | 3-7/8 | 997-128† | 7/16 | 5-1/2 | | | |
| 997-116 | 1/4 | 4 | 997-129† | 29/64 | 5-5/8 | | | |

* These sizes 2 bits per card.

† 3/8 Reduced Shank

'Papco' DRILL BIT MERCHANDISER No. 022-115 (As above)

Contains each of the 29 sizes of drill bits from 1/16" to 1/2" by 64ths., including 3/8" reduced shanks, 1/4" to 1/2" Masonry Bits - and 1/8" double-ended panel drills. A total of 82 cards including an attractive header sign and merchandising rack suitable for wall, pegboard, counter, or gondola display.



No. 997-594 1/8" DOUBLE ENDED PANEL DRILL

High speed ground steel with special 135° split point. Made for body panel work. Starts cutting on contact, won't wander, no centre punch required. 1/8" Dia. x 2" long double-ended. Packed 5 bits per pouch.



Papco DRILL SETS

High Speed Steel
Industrial Grade Drill Bits

5 **pic-a-drill** Sets will fill all your drill bit needs!

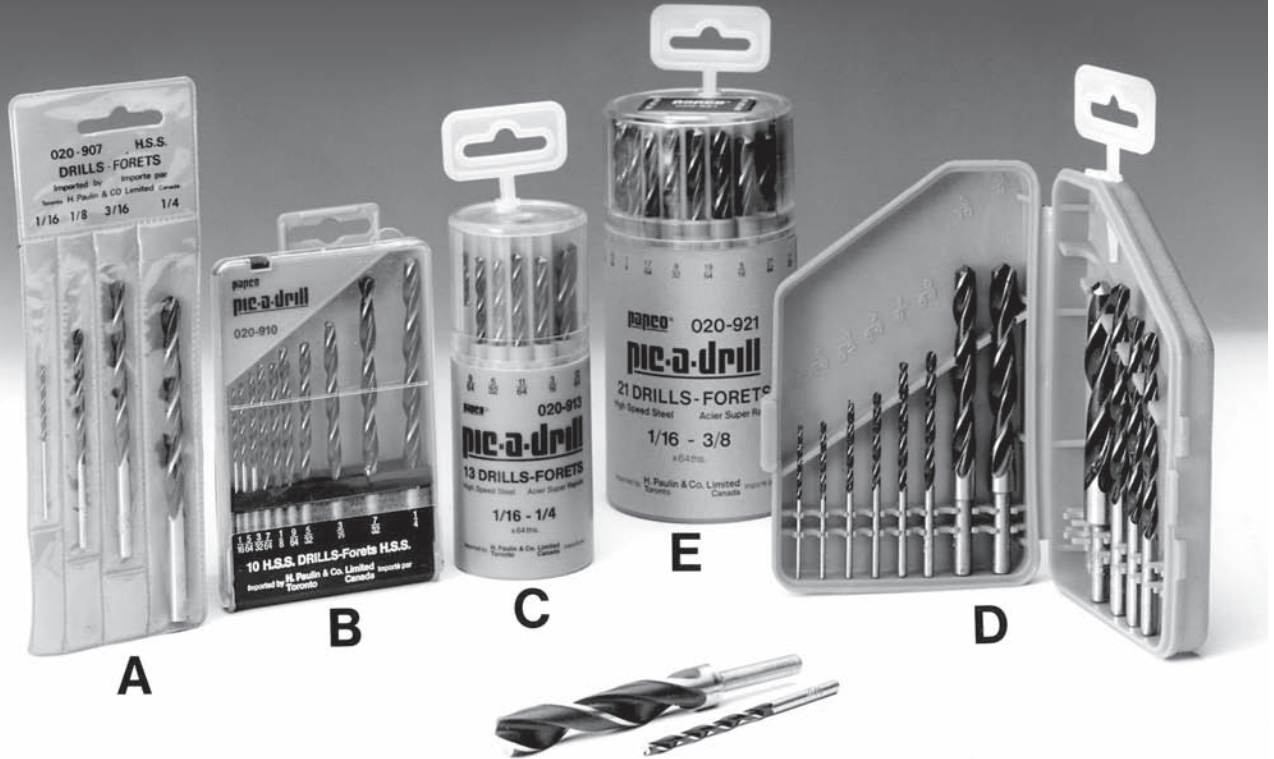

A 'Papco' DRILL BIT ASSORTMENT No. 020-907
4 Pieces – 1/16, 1/8, 3/16, 1/4 H.S.S. 'Pic-a-drill' clear vinyl pouch. The 4 most popular drill sizes. Ideal as a basic kit or to replace worn drills in larger sets.

B 'Papco' DRILL BIT ASSORTMENT No. 020-910
10 Pieces – 1/16 to 1/4 H.S.S.
'Pic-a-drill' rigid styrene case hangs or stands on workbench. Each drill in a separate compartment. Good size coverage in a handy box. 1/16, 5/64, 3/32, 7/64, 1/8, 9/64, 5/32, 3/16, 7/32, 1/4.

C 'Papco' DRILL BIT ASSORTMENT No. 020-913
13 Pieces – 1/16 to 1/4 H.S.S.
'Pic-a-drill' revolving case. 13 popular sizes in a new design rotating case. Dial each size as needed. 1/16, 5/64, 3/32, 7/64, 1/8, 9/64, 5/32, 11/64, 3/16, 13/64, 7/32, 15/64, 1/4.

D 'Papco' DRILL BIT ASSORTMENT No. 020-914
14 Pieces – 1/16 to 1/2 with shanks reduced to 3/8.
'Pic-a-drill' strong folding polypropylene case holds and protects this fine set. 1/16, 5/64, 3/32, 7/64, 1/8, 9/64, 5/32, 3/16, 7/32, 1/4, 5/16, 3/8, and 7/16, 1/2, with 3/8 reduced shanks.

E 'Papco' DRILL BIT ASSORTMENT No. 020-921
21 pieces – 1/16 to 3/8 by 64ths H.S.S.
A complete range of sizes for all requirements. 'Pic-a-drill' revolving case has clear rotating top for fast selection. Drill sizes clearly indexed.

F 'Papco' DRILL BIT MERCHANDISER No. 022-114
A balanced stock of 14 'Pic-a-drill' sets. 6 No. 020-907, 3 No. 020-910, 2 No. 020-913, 2 No. 020-914 and 1 No. 020-921. Includes header sign and merchandising rack. Suitable for wall, pegboard, counter or gondola display.
Size: 16" w. x 14" h. (Illustrated below.)





WOOD SCREWS VIS A BOIS

Length
Longueur



ROUND
RONDE

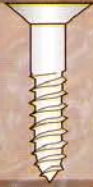

FLAT
FRAISEE



OVAL
OVALE



TAPPING SCREWS VIS TARAUDEUSES



FLAT
FRAISEE



OVAL
OVALE



PAN
DEPOUILLE



TRUSS
BOMBEE



HEX
HEX



MACHINE SCREWS VIS DE MECANIQUE

Length
Longueur



ROUND
RONDE



FLAT
FRAISEE



OVAL
OVALE



PAN
PAN



TRUSS
BOMBEE



FILLISTER
CYLINDRIQUE



HEX
HEX



CARRIAGE
CARROSSE



PLOW
CHARRUE



SQUARE
CARREE



LAG
TIRE-FOND

CAP SCREWS and BOLTS BOULONS ET BOULONS DE PRECISION



SET SCREWS and STUDS VIS DE PRESSION et GOUJONS

Length
Longueur



SOCKET CAP
BOULONS DE PRESSION



SOCKET SET
VIS DE PRESSION



SQUARE SET
PRESSION CARREE



STUDS
GOUJONS



COTTER
GOUPILLE



CLEVIS
JOUG



TAPER
CONIQUE



SPRING
RESSORT

STANDARD PINS GOUPILLES REGULIERE

HEXAGON NUTS ECROUS HEXAGON



WIDTH
Largeur



Thick
Epais

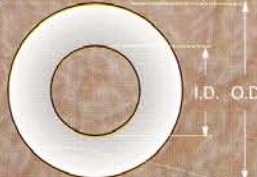

PLAIN STEEL WASHERS
RONDELLES ORDINAIRE



T

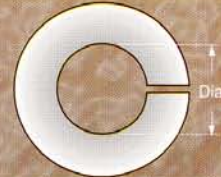

LOCK WASHERS
RONDELLES RESSORT



T

WASHERS RONDELLES