

MARQUE & MODÈLE MAKE & MODEL	ANNÉE YEAR	T-ONE	FILAGE WIRING	CLASS I 2500 LB	CLASS II 3500 LB	CLASS III / IV / V	CAP.	BARRE DE TIRE DRAW BAR	
SUBARU									
Legacy (Cont.)	Exc. Outback	00-04	---	---	---	HH90176	---	---	
		90-99	---	RT1120	---	HH90175	---	---	
Legacy Wagon	Exc. Outback	05-07	---	RT1120	---	D36334 D51177 HH90138	D75560	4	HH80227
		00-04	Voir/See p.372-373	RT1120	---	D36284 HH90176	---	---	---
			Voir/See p.372-373	RT1120	---	HH90175	---	---	---
	00-04	Voir/See p.372-373	RT1120	---	HH90176	---	---	---	
Outback	Sedan, Exc. Sport	05-07	---	RT1120	---	D36334 D51177 HH90138	D75560	4	HH80227
		00-04	Voir/See p.372-373	RT1120	---	D36284 HH90176	---	---	---
	Sedan, Exc. Sport	00-04	Voir/See p.372-373	RT1120	---	D36284 HH90176	---	---	---
Outback Wagon	Exc. Sport	10-13	D118467	RT1120	---	---	D51204	4	HH80227
		---	---	---	---	HH90208	HH87568	4	HH80227
	Exc. Sport	05-09	D118461	RT1120	---	D36334	D75560	4	HH80227
		---	---	---	---	D51177 HH90138	---	---	---
SUZUKI									
Grand Vitara		06-12	D118456	RT1120	D24764ep HH60827ep	---	D75448ep HH87007ep	3.5/4 3.5/4	HH80227 HH80227
		99-05	D118372	RT1120	HH60942	---	D41537	3.5	HH80227
		---	---	---	---	---	D51152	3.5	HH80227
		---	---	---	---	---	HH87005	3.5	HH80227
		---	---	---	---	---	---	---	---
Sidekick	not Sport	89-98	D118372	RT1120	D24622	---	---	---	
SX4	Sport Sedan	08-09	D118475	RT1120	D24818 HH60204	---	---	---	---
		07-11	D118456	RT1120	D24817 HH60202	---	---	---	---
Swift	5 dr	04-09	---	RT1120	D24741	---	---	---	
Vitara		99-05	D118372	RT1120	D24673	---	D41537	3.5	HH80227
		---	---	---	---	---	D51152	3.5	HH80227
		---	---	---	---	---	HH87005	3.5	HH80227
X-90		96-98	---	RT1120	D24622hp	---	---	---	
XL-7		07-09	---	RT1120	---	---	HH87436	4	HH80227
		01-06	D118372	RT1120	D24673	---	D41537	3.5	HH80227
			---	---	HH60942	---	D51152	3.5	HH80227
			---	---	---	---	HH87005	3.5	HH80227
TOYOTA									
4 Runner		03-09	---	D119176	---	---	D75155ep	6/7.3	HH80227
		96-02	D118341	RT1120	---	D36223	HH87477	5/5.5	HH80239
Avalon		05-12	---	D119176	HH60287	---	---	---	---
		95-99	---	RT1120	---	D36336	---	---	---
			---	---	---	D51178	---	---	---
Camry	4 dr Sedan, Exc. Hybrid	2012	D118405	D119176	---	HH90079sv	---	---	---
		07-11	Voir/See p.372-373	D119176	---	D36416	---	---	---
			---	---	---	D51190	---	---	---
	4 dr Sedan	05-06	D118308	RT1120	---	HH90152	---	---	---
		---	---	---	---	D36336	---	---	---
4 dr Sedan	97-04	Voir/See p.372-373	RT1120	D24715	D36336	D51178	---	---	
---	---	---	---	---	D36336	D51178	---	---	



MARQUE & MODÈLE MAKE & MODEL	ANNÉE YEAR	T-ONE	FILAGE WIRING	CLASS I 2500 LB	CLASS II 3500 LB	CLASS III / IV / V	CAP.	BARRE DE TIRE DRAW BAR	
TOYOTA									
Camry 2 & 4 dr	92-96	---	D119176	---	D36336 D51178	---	---	---	
Corolla	03-13	Voir/See p.372-373	D119176	D24814 D51171	---	---	---	---	
	03-08	Voir/See p.372-373	D119176	HH60964	---	---	---	---	
	93-02	---	RT1120	D24579 HH60838	---	---	---	---	
Echo Hatchback Exc. Turbo Exc. Hatchback	04-05	---	RT1120	D24751 HH60987	---	---	---	---	
	00-05	Voir/See p.372-373	RT1120	HH60923ep	---	---	---	---	
	00-02	D118386	RT1120	D24694	---	---	---	---	
FJ Cruiser	07-13	D118405	RT1120	---	---	D51087 D75461 HH87412	5/6 5/6 5/6	HH80239 HH80239 HH80239	
	Highlander Exc. Spare 19'	08-13	D118449	D119176	---	---	HH87615ep	5	HH80227
		08-13	D118449	D119176	---	---	D51158	5	HH80227
04-07		---	---	---	---	HH87452	5	HH80227	
		D118248	RT1120	---	---	D51155	3.5	HH80227	
01-03	---	---	---	---	D75153	3.5	HH80227		
	D118413	RT1120	---	D36271	HH70778	3.5	HH80227		
	---	---	---	---	D51153	3.5	HH80227		
Land Cruiser	98-07	Voir/See p.372-373	RT1120	---	---	D75095	5/6	HH80227	
	Matrix	03-13	Voir/See p.372-373	D119176	D24812 D51169 HH60898	---	---	---	---
w/ Ground effect		03-08	D118336	RT1120	HH60965	---	---	---	
w/o Ground effect		03-08	D118336	RT1120	HH60958	---	---	---	
Prius 4 dr Sedan, Exc. Plug-in model	12-13	---	D119176	D24847 HH60263	---	---	---	---	
	10-11	D118505	D119176	D24847 HH60263	---	---	---	---	
	04-09	D118505	D119176	D24808sc HH60894sc	---	---	---	---	
Prius C	2012	---	D119176	HH60308	---	---	---	---	
Prius V	2012	---	---	D24847 HH60263	---	---	---	---	
		---	---	---	---	---	---	---	
RAV4	06-12	D118412	D119176	---	---	D51157 HH70785 D75432	3.5/4 3.5/4 3.5/4	HH80227 HH80227 HH80227	
	96-05	Voir/See p.372-373	RT1120	D24704 HH60938	---	D75125	3.5	HH80227	

Sequoia	08-12	---	D	---	---	HH87488	---	HH80239	
Sienna	11-13	D118498	D119176	---	HH90217	D51196 HH87586	3.5/5 3.5/5	HH80239 HH80239	
	04-13	Voir/See p.372-373	D119176	---	HH90214	D51080	3.5/5	HH80239	
						D75149	3.5/5	HH80239	
						HH87415	3.5/5	HH80239	
98-03	---	RT1120	---	HH90638	HH87638	3.5/5	HH80227		
Solara	04-09	---	D119176	---	HH90652	---	---	---	
	99-03	---	RT1120	D24715	D36336	---	---	---	
	---	---	---	---	D51178	---	---	---	



MARQUE & MODÈLE MAKE & MODEL		ANNÉE YEAR	T-ONE	FILAGE WIRING	CLASS I 2500 LB	CLASS II 3500 LB	CLASS III / IV / V	CAP.	BARRE DE TIRE DRAW BAR
TOYOTA									
Tacoma	Exc. X Runner	05-13	D118496	D119176	---	---	D51146	5/5.5	HH80227
			---	---	---	---	D75236	5/5.5	HH80227
			---	---	---	---	HH87581	5/5.5	HH80227
		98-04	D118379	---	---	---	HH87579	5/5.5	HH80227
	Starts 95 1/2	95-04	D118379	---	---	---	D51108	5/5.5	HH80227
Tercel		91-98	---	RT1120	HH60882	---	---	---	---
Tundra		07-13	---	---	---	---	D51091	6/8	HH80239
			---	---	---	---	HH87434	6/8	HH80239
			---	---	---	---	HH41935	12/14	D4280
		00-06	Voir/See p.372-373	---	---	---	D51047	5/7.5	HH80239
			---	---	R37034	---	7/12	---	
Venza		09-13	D118482	D119176	---	HH90213	HH87521	---	---
Yaris	5 dr Liftback	09-11	---	RT1120	D24819	---	---	---	---
			---	---	HH60209	---	---	---	---
	3 dr Liftback & 4 dr Sedan	07-11	Voir/See p.372-373	RT1120	D24819	---	---	---	---
			---	---	HH60209	---	---	---	
VOLKSWAGEN									
Beetle	Exc. Turbo S	12-13	---	D119176	HH60294	---	---	---	---
	Exc. Turbo S	98-10	---	RT1120	D24679	---	---	---	---
CC	Exc. 4 motion	09-13	---	D119176	D24848ep	---	---	---	---
			---	---	HH60264ep	---	---	---	---
City Golf		07-10	---	RT1120	D24679	---	---	---	---
			---	---	HH60943	---	---	---	---
City Jetta	Sedan	07-09	---	RT1120	D24748	---	---	---	---
			---	---	HH60963	---	---	---	---
EOS		07-12	---	D119190	D24824	---	---	---	---
			---	---	HH60211	---	---	---	---
Golf	2 & 4 dr Hatchback, Exc. R Models	10-13	---	D119176	D24825	---	---	---	---
			---	---	HH60212	---	---	---	---
	Wagon	10-12	---	D119176	HH60283	---	---	---	---
	3 & 5 dr Hatchback, Exc. R Models	10-12	---	D119176	D24825	---	---	---	---
				---	---	HH60212	---	---	---
		99-06	---	RT1120	D24679	---	---	---	---
	Exc. GTI V6	99-06	---	RT1120	HH60943	---	---	---	---
Golf GTI	3 & 5 dr Hatchback	10-12	---	---	HH60267	---	---	---	---
GTI	4 dr Hatchback	10-13	---	D119190	HH60267	---	---	---	---
	4 dr Hatchback	10-12	---	D119190	HH60267	---	---	---	---
	4 dr Hatchback	07-09	---	D119190	D24825	---	---	---	---
				---	---	HH60212	---	---	---
	2 dr Hatchback	06-09	---	D119190	D24825	---	---	---	---
			---	---	HH60212	---	---	---	
Jetta	4 dr Sedan	05-13	Voir/See p.372-373	D119176	HH60283	---	---	---	---
	Sedan Old Body & Wagon Exc. Turbo	99-05	---	RT1120	D24748	---	---	---	---
	Jetta III	94-98	---	RT1120	D24594	---	---	---	---
Jetta SportWagen		09-13	---	D119176	HH60283	---	---	---	
Jetta Wagon		03-06	---	RT1120	HH60984	---	---	---	
Passat	4 dr Sedan	12-13	---	D119190	HH60297ep	---	---	---	---
	4 dr Sedan, Exc. 4 Motion	06-10	D118562	D119190	D24848ep	---	---	---	---
			---	---	HH60264ep	---	---	---	---
	Sedan & Wagon Exc. 4 Motion & W8	99-05	---	RT1120	HH60991	---	---	---	---
Passat Wagon	Exc. 4 Motion	07-10	D118530	D119190	D24848ep	---	---	---	
			---	---	HH60264ep	---	---	---	

MARQUE & MODÈLE MAKE & MODEL	ANNÉE YEAR	T-ONE	FILAGE WIRING	CLASS I 2500 LB	CLASS II 3500 LB	CLASS III / IV / V	CAP.	BARRE DE TIRE DRAW BAR
VOLKSWAGEN								
Rabbit	06-09	---	D119190	D24825 HH60212	---	---	---	---
Routan	09-12	D118490	D119176	---	D36455 D51192 HH90169	D51203 D75579 HH87451	4 4/5 4/5	HH80227 HH80227 HH80227
Tiguan	09-13	---	D119190	---	D36474ep HH90191ep	HH87600ep	3.5	---
Touareg	04-10	D118509	D119176	---	---	D75363	6	HH80227
VOLVO								
C30	08-10	---	D119176	D24811 HH60897	---	---	---	---
C70	Convertible Coupe	98-04 98-02	D119176	---	D36262	---	---	---
S40	New Body Old Body	04-11 00-04	D119176	D24781 HH60852 D24688	---	---	---	---
S60 Sedan	01-09	---	D119176	---	D36297 D51172 HH90804	---	---	---
S70 Sedan	98-00	---	D119176	---	D36262	---	---	---
S80 Sedan	07-13	D118454	D119176	---	HH90171	---	---	---
V40 Wagon	00-04	---	D119176	D24688	---	---	---	---
V70 Wagon	08-10 01-07 98-00	D118463 --- ---	--- D119176 ---	--- ---	--- D36297 D51172 HH90804 D36262	HH87484ep	4	HH80227
XC60	10-13	D118523	D119176	---	---	D75671	4/4.5	HH80227
XC70 Wagon	AWD 08-13	---	D119176	---	---	HH87484ep	4	HH80227
XC90	03-13	Voir/See p.372-373	D119176	---	---	HH87810	5	HH80227

LEXIQUE / FOOT NOTES

AB Requiert 4 plaques de boulons (3/8") (01077-011) pour installation. Vendu séparément. <i>Requires 4 (3/8") spacer blocks (01077-011) for installation. Sold seperatly.</i>	HP Requiert 4 (7/16" x 1" x 2") plaques de boulons (01080-012) pour l'installation. Vendu séparément. <i>Requires 4 (7/16" x 1" x 2") spacer blocks (01080-012) for installation. Sold separately.</i>
AO Exclus véhicules avec système d'échappement double / <i>Will not fit vehicles with twin tailpipes</i>	MB Ne fait pas sur véhicules équipé d'une suspension pneumatique. <i>Will not fit models equipped with air suspension package.</i>
BC Classé/Rated: 1500/150 lb	N Ne pas couper our relier le filage du véhicule. Utiliser seulement un T-One approuvé ou demander au concessionnaire auto pour le filage. <i>Do not cut or splice vehicle wiring. Only use approved T-One or see auto dealer for tow wiring kit.</i>
BF Pare-chocs standard requis. Ne fait pas sur pare-chocs à marche. <i>Requires standard bumper. Will not fit with step bumper.</i>	O Exclus échappement double à l'arrière / <i>Will not fit on rear dual exhaust</i>
CN Pare-chocs d'origine requis pour l'installation de l'attelage. <i>Requires OEM factory bumper for hitch installation.</i>	P Adapteur 2626 requis sur 124" W.B. et E350 (vendu séparément) <i>Adapter kit 2626 requide on 124" W.B. and E350 (sold separately)</i>
CP Fait sur tout les modèles sans attaches remorque d'origine installé <i>Fits all models w/o factory installed receiver</i>	RC Exclus modèle avec "Sport bar" à l'arrière / <i>Will not fit with rear sport bars</i>
CQ Incompatible avec suspension H.D. / <i>Will not fit with H.D. suspension</i>	RN Exclus modèle "Extreme pack" / <i>Will not fit extreme pack</i>
DA Exclus avec pare-choc de type "Step bar" / <i>Will not fit with tube style bumper</i>	RO Exclus Silverado SS / <i>Will fit Silverado SS</i>
DH Ne peut pas être installé sur véhicules avec pare-chocs à marche de 1987-97 sauf si le pare-chocs à marche et les supports de montage sont retirés définitivement et que le pare-choc d'origine est installé. <i>Can't be installed on 1987/97 vehicles with factory step bumpers unless step bumper and its mounting brackets are permanently removed and standard factory bumper is installed.</i>	S Classé/Rated: 2500/250 lb
EP Trimage de fascia requis / <i>Fascia trimming required</i>	SE Exclus véhicule à empattement court et barres anti-roulis / <i>Not short wheel base and roll bar</i>
GU Exclus les fascia bas / roll pan ou pare-choc tubulaire / <i>Will not fit with lowered fascia / roll pan or tube type bumper</i>	SV Doit couper ou enlever le panneau esthétique sous le véhicule <i>Trimming or removal of under body appearance panel required</i>
HC Exclus avec roue de secours sous l'auto / <i>Will no fit with any spare tire under car</i>	V Pour véhicule avec pare-choc "Step bumper" / <i>For vehicle with factory step bumper</i>
	* Exclus véhicule aillant une roue de secours sous le véhicule / <i>Not for spare under vehicle</i>

ATTELAGES / HITCHES



CLASS I & II

Jusqu'à / Up to : 2,000 lb
Receveur / Receiver : 1 1/4"

- Inclut barre de tire, cheville, goupille et couvert pour receveur
- Finition de peinture noir en revêtement poudré en polyester résistant à la corrosion
- Includes ball mount, pin & clip and receiver cover
- Finish is corrosion resistant powdercoat polyester black paint



CLASS III, IV, MULTI-FIT

Jusqu'à / Up to : 5,000 lb

- Facile à installer
- Ouverture de receveur 2"
- Revêtement poudré en polyester noir contre la corrosion
- Easy to install
- 2" receiver opening
- Corrosion black resistant powdercoat polyester

		CLASS I & II 1 1/4" x 1 1/4" - Jusqu'à/Up to: 2,000 lb				CLASS III, IV, MULTI-FIT 2" x 2" - Jusqu'à/Up to: 5,000 lb			
MARQUE & MODÈLE MAKE & MODEL	ANNÉE YEAR	# PIÈCE PART #	CAP.	AUCUN PERÇAGE NO DRILL	# PIÈCE PART #	CAP.	AUCUN PERÇAGE NO DRILL	DIST. POIDS WEIGHT DIST.	
CHEVROLET / GMC									
Aveo	Hatchback only, will not fit Sedan	04-11	VA59170	2	---	---	---	---	
NISSAN									
Murano		03-07	---	---	---	VA82660	3.5	√	
Rogue		08-13	VA66661	3.5	√	---	---	---	
PONTIAC									
G3		09-10	VA59170	2	---	---	---	---	
SATURN									
Vue	All	08-11	---	---	---	VA82543	4	√	

ATTELAGÉ 5^E ROUE / 5TH WHEEL HITCH



SANS RAILS / WITHOUT RAILS

POWERPULL

VA70480

16,000 - 4,000 lb

Inclut base glissante. Rails de base vendu séparément.
Ajustement de 14 1/2" to 18 1/16" avec 1 3/16" d'incrément.
With glider. Base rail sold separately.
Adjust from 14 1/2" to 18 1/16" in 1 3/16" increment.

BARRURE DE PORTE CAMLOCK CARGO DOOR LOCK



VA75632

Sécurise les portes avant et arrière
Secures rear and front cargo doors

REESE

ATTELAGES 5° ROUE / 5TH WHEEL HITCHES

• SELECT SERIES •

SANS RAIL / WITHOUT RAIL

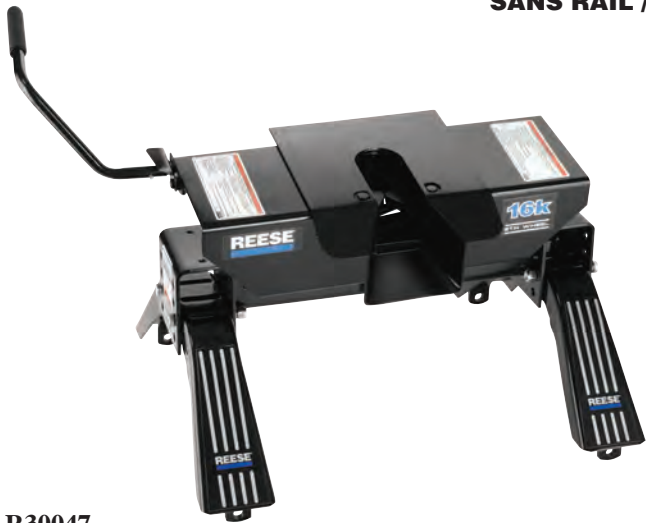

R30047
16,000 - 4,000 lb

- Nécessite rails et ens. d'installation **R30035** (Vendu séparément)
Use with rail and installation kit R30035 (Sold separately)
- Système de barrure à machoire / *Double jaw system lock.*
- Hauteur ajustable / *Adjustable height: 15" - 18"*
- Tête pivotant de gauche à droite 4° à 5°
Pivot head from left to right 4° to 5°.



R30033
22,000 - 5,500 lb

- Nécessite rails et ens. d'installation **R30035** (Vendu séparément)
Use with rail and installation kit R30035 (Sold separately)
- Système de barrure à machoire / *Double jaw system lock.*
- Hauteur ajustable / *Adjustable height: 14" - 18"*
- Tête pivotant de gauche à droite / *Pivot head from left to right*
- Incluant fillage 90° / *Includes 90° wiring : #50-97-410*

AVEC BASE GLISSANTE, SANS RAILS / WITH SLIDER, WITHOUT RAILS



R30051
16,000 - 4,000 lb

- Nécessite rails et ens. d'installation **R30035** (Vendu séparément)
Use with rail and installation kit R30035 (Sold separately)
- Système de barrure à machoire / *Double jaw system lock.*
- **R30047 + KWIK-SLIDE (R30048).**
- Base glissante donne 10" de jeu / *Slider gives 10" travel.*
- Hauteur ajustable / *Adjustable height: 15" - 18"*
- Tête pivotant de gauche à droite 4° à 5° / *Pivot head from left to right 4° to 5°.*



R30075
16,000 - 4,000 lb

- Nécessite rails et ens. d'installation **R30035** (Vendu séparément)
Use with rail and installation kit R30035 (Sold separately)
- Base glissante, tube rond / *Round tube slider.*
- Base glissante donne 12" de jeu / *Slider gives 12" travel.*
- Système de barrure à machoire / *Double jaw system lock.*
- Hauteur ajustable / *Adjustable height: 15" - 18"*
- Tête pivotant de gauche à droite 4° à 5° / *Pivot head from left to right 4° to 5°.*

ATTELAGES 5° ROUE / 5TH WHEEL HITCHES

• PRO SERIES •

SANS RAIL / WITHOUT RAIL



R30093
15,000 - 3,750 lb

- Nécessite rails et ens. d'installation **R30035** ou **R30095** (Vendu séparément)
Use with rail and installation kit R30035 or R30095 (Sold separately)
- Système de barrure barre plate / *Flat bar locking system*
- Hauteur ajustable / *Adjustable height: 13" à/ to 17"*
- Tête pivotant de gauche à droite 5° / *Pivot head from left to right 5°*



R30855
16,000 - 4,000 lb

- Nécessite rails et ens. d'installation **R30035** ou **R30095** (Vendu séparément)
Use with rail and installation kit R30035 or R30095 (Sold separately)
- Système de barrure à mâchoire / *Double jaw system lock*
- Hauteur ajustable / *Adjustable height: 13" à/ to 17"*
- Tête flottante / *Full floating head*

AVEC RAIL / WITH RAIL



R30128
15,000 - 3,750 lb

- Inclus rails et ens. d'installation **R30035**
Includes rail and installation kit R30035
- Système de barrure barre plate / *Flat bar locking system*
- Hauteur ajustable / *Adjustable height: 13" à/ to 17"*
- Rail de 10 boulons / **10 bolt rail**
- Tête pivotant de gauche à droite 5° / *Pivot head from left to right 5°*



R30856
16,000 - 4,000 lb

- Inclus rails **R30095**. Système de barrure à mâchoire.
Includes rail R30095. Double jaw system lock.
- Hauteur ajustable / *Adjustable height: 13" à/ to 17"*
- Rail de 4 boulons / **4 bolt rail**
- Tête flottante / *Full floating head*



R31859
16,000 - 4,000 lb

- Inclus rails et ens. d'installation **R30035**
Includes rail and installation kit R30035
- Système de barrure à mâchoire / *Double jaw system lock*
- Hauteur ajustable / *Adjustable height: 13" à/ to 17"*
- Rail de 10 boulons / **10 bolt rail**
- Tête flottante / *Full floating head*



R30132
29,000 - 5,000 lb

- Inclut rails et ensemble d'installation **R30035**
Includes rail and installation kit R30035
- Hauteur ajustable / *Adjustable height: 13" à/ to 17"*
- Système de barrure à machoire / *Double jaw system lock*
- Rail de 10 boulons / **10 bolt rail**
- Tête flottante / *Full floating head*

ATTELAGES 5° ROUE / 5TH WHEEL HITCHES

• PRO SERIES •

AVEC BASE GLISSANTE, SANS RAILS / WITH SLIDER, WITHOUT RAILS



R30094
15,000 - 3,750 lb

- Nécessite rails et ens. d'installation **R30035** ou **R30095** (Vendu séparément).
- Use with rail and installation kit **R30035** or **R30095** (Sold separately)
- Système de barrure barre plate / Flat bar locking system.
- Hauteur ajustable / Adjustable height: 13" à/to 17".
- Base glissante donne 10" de jeu / Slider gives 10" travel.
- Tête pivotant de gauche à droite 5° / Pivot head from left to right 5°.



R30857
16,000 - 4,000 lb

- Nécessite rails et ens. d'installation **R30035** ou **R30095** (Vendu séparément).
- Use with rail and installation kit **R30035** or **R30095** (Sold separately)
- Système de barrure à mâchoire / Double jaw system lock.
- Hauteur ajustable / Adjustable height: 13" à/to 17".
- Base glissante donne 10" de jeu / Slider gives 10" travel.
- Tête flottante / Full floating head.

AVEC BASE GLISSANTE ET RAILS / WITH SLIDER AND RAILS



R30129
15,000 - 3,750 lb

- Inclus rails et ensemble d'installation **R30035**
includes rail and installation kit **R30035**
- Système de barrure barre plate / Flat bar locking system.
- Hauteur ajustable / Adjustable height: 13" à/to 17".
- Base glissante donne 10" de jeu / Slider gives 10" travel.
- Rail de 10 boulons / 10 bolt rail.
- Tête pivotant de gauche à droite 5° / Pivot head from left to right 5°.



R31860
16,000 - 4,000 lb

- Inclus rails et ens. d'installation **R30035**
Includes rail and installation kit **R30035**
- Système de barrure à mâchoire / Double jaw system lock.
- Hauteur ajustable / Adjustable height: 13" à/to 17".
- Base glissante donne 10" de jeu / Slider gives 10" travel.
- Rail de 10 boulons / 10 bolt rail.
- Tête flottante / Full floating head.



R30133
20,000 - 5,000 lb

- Inclus rails et ens. d'installation **R30035**
Includes rail and installation kit **R30035**
- Système de barrure à mâchoire / Double jaw system lock.
- Hauteur ajustable / Adjustable height: 13" à/to 17".
- Base glissante donne 10" de jeu / Slider gives 10" travel.
- Rail de 10 boulons / 10 bolt rail.
- Tête flottante / Full floating head.

REESE

ATTELAGES 5° ROUE / 5TH WHEEL HITCHES

• ELITE SERIES • • INSTALLATION SOUS LA BOÎTE DU CAMION / UNDER BED INSTALLATION •

SANS RAILS / WITHOUT RAILS



R30142

18,000 - 4,500 lb

- Pivotant 4 sens/4 way head pivot
- Hauteur ajustable / Adjustable height: 14" à/ to 18¼"
- Indicateur de pivot/Kingpin indicator.
- 9" d'entonnoir (vs 6"), connection plus facile
Wider 9" (vs 6") kingpin funnel area.
- Inclut filage 90° pour boîte #5097410
Includes 90° Fifth Wheel adapter Harness #5097410
- Tête pivotant de gauche à droite 4°
Pivot head from left to right 4°.
- Préassemblé / Pre-assembled



R30143

25,000 - 6,250 lb

- Pivotant 4 sens/4 way head pivot.
- Hauteur ajustable / Adjustable height: 14" à/ to 16½"
- Indicateur de pivot/Kingpin indicator.
- 9" d'entonnoir (vs 6"), connection plus facile
Wider 9" (vs 6") kingpin funnel area.
- Inclut filage 90° pour boîte #5097410
Includes 90° Fifth Wheel adapter Harness #5097410
- Tête pivotant de gauche à droite 4°
Pivot head from left to right 4°.
- Préassemblé / Pre-assembled

AVEC BASE GLISSANTE, SANS RAILS / WITH SLIDER, WITHOUT RAILS



R30144

18,000 - 4,500 lb

- Hauteur ajustable / Adjustable height: 14" à/ to 18"
- Base glissante donne 10" de jeu / Slider gives 10" travel.
- Empattement plus large de la base d'appui (plus de stabilité)
Wider footprint for increased stability.
- 9" d'entonnoir (vs 6"), connection plus facile
Wider 9" (vs 6") kingpin funnel area.
- Inclut filage 90° pour boîte #5097410
Includes 90° Fifth Wheel adapter Harness #5097410
- Tête pivotant de gauche à droite 4°
Pivot head from left to right 4°.
- Préassemblé / Pre-assembled

ENSEMBLES DE RAIL / RAIL KITS



CHEVROLET / GMC

25,000 - 6,250 lb

11-13 Silverado/Sierra 2500/3500 HD

R30868

DODGE / RAM

10-12 Ram 2500/3500 HD

R30852

FORD

11-13 F250/350/450 SD **not** cab and chassis

R30126

REESE

ATTELAGES 5° ROUE / 5TH WHEEL HITCHES

• SELECT SERIES •



R30081
20,000 - 5,000 lb

- Nécessite rails et ens. d'installation **R30035** (Vendu séparément)
*Use with rail and installation kit **R30035** (Sold separately)*
- Hauteur ajustable / *Adjustable height: 14" à 18".*
- Indicateur de pivot / *Kingpin indicator.*
- 9" d'entonnoir (vs 6"), connection plus facile / *Wider 9" (vs 6") kingpin funnel area.*
- Tête pivotant de gauche à droite 6° / *Pivot head from left to right 6°.*



R30083
20,000 - 5,000 lb

- Nécessite rails et ens. d'installation **R30035** (Vendu séparément)
*Use with rail and installation kit **R30035** (Sold separately)*
- Hauteur ajustable / *Adjustable height: 14" à 18".*
- Indicateur de pivot / *Kingpin indicator.*
- 9" d'entonnoir (vs 6"), connection plus facile / *Wider 9" (vs 6") kingpin funnel area.*
- Tête pivotant de gauche à droite 6° / *Pivot head from left to right 6°.*
- Avec base glissante ronde / *With round slider.*



R30084
20,000 - 5,000 lb

- Nécessite rails et ens. d'installation **R30035** (Vendu séparément)
*Use with rail and installation kit **R30035** (Sold separately)*
- Hauteur ajustable / *Adjustable height: 14" à 18".*
- Indicateur de pivot / *Kingpin indicator.*
- 9" d'entonnoir (vs 6"), connection plus facile / *Wider 9" (vs 6") kingpin funnel area.*
- Tête pivotant de gauche à droite 6° / *Pivot head from left to right 6°.*
- Avec base glissante carré / *With square slider.*

BASE GLISSANTE / SLIDER

KWIK-SLIDE™



R30048

Base glissante donnant 10" de jeu procurant une plus grande manoeuvrabilité aux camions à boîte courte. Utiliser avec rails et ens. d'installation **R30035** ou **R30095** (Vendu séparément). Pour les attelages 5° roue de **15,000 lbs** et **16,000 lbs**. Course: 10".

*Fifth wheel slider giving 10" travel providing greater turning clearance for short bed trucks. Use with **R30035** or **R30095** rail and installation kit (Sold separately). Fits both **15K** & **16K** models. Travel: 10".*

ADAPTATEUR POUR ENSEMBLE DE MONTAGE MOUNTING KIT ADAPTER



R30156

Pour sellette standard de **15,000 lbs**, **16,000 lbs** & **20,000 lbs**
For **15K**, **16K** & **20K** standard wheel hitches

(s'adapte au rail OEM FORD/for use with Ford OEM Under-rail kit)

REESE

ATTELAGES 5° ROUE / 5TH WHEEL HITCHES

• R16 •

SANS RAILS / WITHOUT RAILS



R30866
16,000 - 4,000 lb

- Nouvelle poignée profilée / *New contoured handle*
- Tête & mâchoire moulée / *Cast head & jaw*
- Rayon de pivot moulé / *Cast pivot beam*

AVEC BASE GLISSANTE, SANS RAILS WITH SLIDER, WITHOUT RAILS

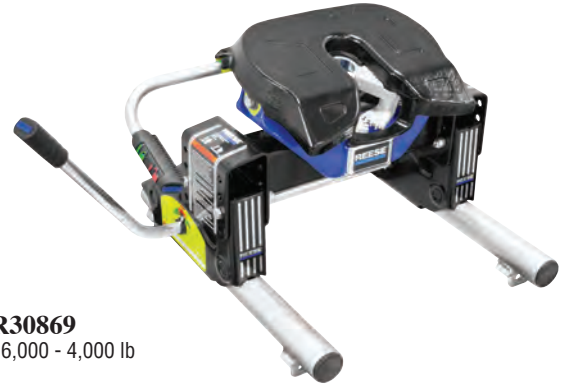

R30869
16,000 - 4,000 lb

- Base glissante, tube rond / *Round Tube Slider*
- Nécessite rails et ens. d'installation # **R50024**
Requires rail & installation kit # R50024
- Ensemble de rails vendus séparément / *Rail kit Sold Separately.*

• R20 •

SANS RAILS / WITHOUT RAILS



R30867
20,000 - 5,000 lb

- Ensemble de rails vendus séparément
Rail Kit Sold Separately

AVEC BASE GLISSANTE, SANS RAILS WITH SLIDER, WITHOUT RAILS



R30870
20,000 - 5,000 lb

- Base glissante, tube rond / *With Round Tube Slider*
- Nécessite rails et ens. d'installation # **R50024**
Requires rail & installation kit # R50024
- Ensemble de rails vendus séparément / *Rail Kit Sold Separately*



ATTELAGES 5° ROUE / 5TH WHEEL HITCH



D9480
18,000 - 4,500 lb

- Convertit un col-de-cygne en un attelage 5e roue
Converts a gooseneck hitch into a 5th Wheel Hitch.
- 2 boulons pour ajustement de la hauteur / *2 Bolts for Bed Height Adjustments*
- Pattes conçues pour faire contrepoids lors du freinage
Offset Legs Enhance Performance While Braking
- Stabilisateur ajustable pour épouser le motif de la caisse
Adjustable Stabilizer Strips Fit Bed Corrugation Pattern
- Poignée extensible et verrouillable / *Lockable, Extended Length Handle*
- Hauteur ajustable / *Adjustable height: 14-1/4" à 18"*
- Tête pivotante "4-Way" avec machoires à auto-verrouillage
4-Way Pivoting Head with Self Latching Jaw Design
- Tête pivotant de gauche à droite 4° / *Pivot head from left to right 4°.*

• ENSEMBLES D'INSTALLATION / INSTALLATION KITS •

ENSEMBLE D'INSTALLATION UNIVERSELS / UNIVERSAL INSTALLATION KITS

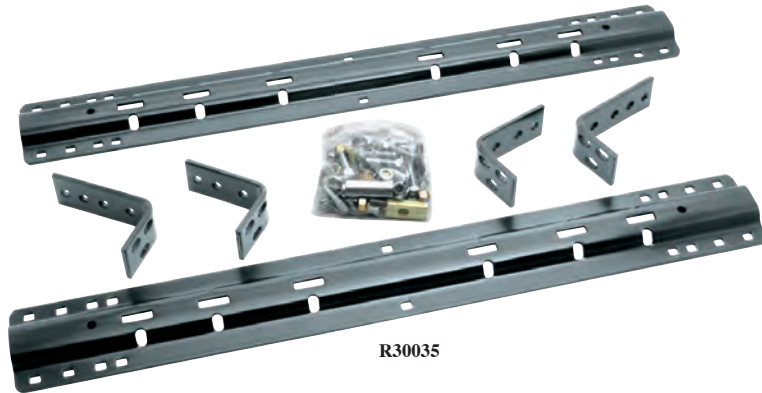

R30035

R30035

Rails et ensemble d'installation (10 boulons)
Rail and installation kit (10 bolts)

R30095

Rails et ensemble d'installation (4 boulons)
Rail and installation kit (4 bolts)

R58058

Rail seul (10 boulons)
Rail only (10 bolts)

ENSEMBLE DE RAIL ROBUSTE / HEAVY DUTY RAIL KIT



R30153

Ensemble de rail HD, incluant quincaillerie de calibre 8, rail 48" pour installation plus rapide.
Ensemble de support vendu séparément.
Heavy duty mounting rail kit, includes grade 8 hardware, 48" rail for faster installation.
Support kits sold separately.

PIÈCES DE RECHANGE / REPLACEMENT PARTS



R30439

Ens. d'installation pour R30035 & R58058
Installation kit for R30035 & R58058



R55055

Boulon moletté 1/2" - 13 x 1 1/2"
Knurl bolt 1/2" - 13 x 1 1/2"
Vendu à l'unité / Sold per unit

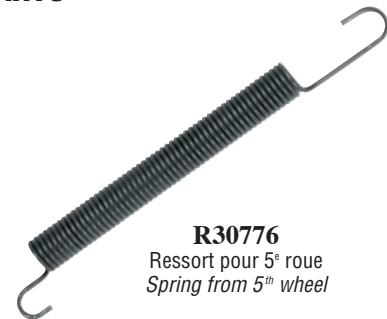

R30776

Ressort pour 5^e roue
Spring from 5th wheel



PLAQUETTE DE GRAISSAGE POUR 5^E ROUE 5TH WHEEL LUBE PLATE

R83002
10"

R83001
12"

REESE

• ENSEMBLES D'INSTALLATION / INSTALLATION KITS •

L'ENSEMBLE INCLUT RAILS ROBUSTE
KIT INCLUDES HEAVY DUTY RAILS



ENSEMBLES DE SUPPORTS OU
ENS. DE RAILS ET DE SUPPORTS
BRACKET KITS OR
RAIL AND SUPPORT KITS



R56001



R56002



R56003



R56004

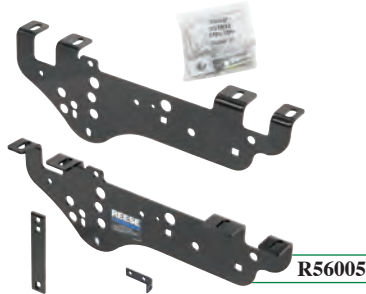

R56005



R56006



R56007

Description

CHEVROLET / GMC Silverado/Sierra 2500/3500HD 11-13
CHEVROLET / GMC Silverado/Sierra 2500/3500HD 07-10
CHEVROLET / GMC Silverado/Sierra 1500LD 99-13,
 1500HD 6.6' Classic 01-07, 2500LD 99-04, 2500HD 01-10, 3500HD 01-10
DODGE Ram 2500/3500HD 03-10
FORD F150 Not heritage 04-13
FORD F250/350/450SD 11-13
FORD F250/350SD 99-10, F450SD 08-10
RAM 3500HD 2013
RAM 2500/3500HD 11-12



ENSEMBLES DE SUPPORTS BRACKET KITS

R56001
 R56004
 R56007

 R56003
 R56006
 R56002
 R56005
 R56008
 R56003



ENSEMBLES RAILS ET SUPPORTS RAIL AND SUPPORT KITS

R56001-53
 R56004-53
 R56007-53

 R56003-53
 R56006-53
 R56002-53
 R56005-53
 R56008-53
 R56003-53

REESE

ENSEMBLES DE SUPPORTS / BRACKETS KITS

ENSEMBLE D'INSTALLATION RAPIDE SUR MESURE / CUSTOM QUICK INSTALL KITS



Ens. inclus quincaillerie, supports fait sur mesure et rails
Kit includes hardware, custom fit brackets and rails

	CHEVROLET / GMC	4 boulons/bolts	10 boulons/bolts
11-13	Silverado/Sierra 2500/3500 HD	R50066-24	R50066-58
01-10	Silverado/Sierra 2500/3500 HD	---	R50064-58
01-07	Silverado/Sierra 1500 HD Classic	---	R50064-58
99-13	Silverado/Sierra 1500 LD	---	R50064-58
99-04	Silverado/Sierra 2500 LD	---	R50064-58
DODGE / RAM			
09-12	Ram 1500 Quad Cab 6.4'	R50083-24	R50083-58
09-12	Ram 1500 Reg. Cab	R50083-24	R50083-58
FORD			
99-10	F250/350 SD	---	R50082-58
04-13	F150	---	R50081-58
TOYOTA			
07-13	Tundra	---	R50084-58

SUPPORTS D'INSTALLATION RAPIDE SUR MESURE / CUSTOM QUICK INSTALL BRACKETS



CHEVROLET / GMC		
11-13	Silverado/Sierra 2500/3500 HD	R50066
01-10	Silverado/Sierra 2500/3500 HD	R50064
01-07	Silverado/Sierra 1500 HD	R50064
99-13	Silverado/Sierra 1500 LD	R50064
99-04	Silverado/Sierra 2500 LD	R50064
DODGE / RAM		
09-12	Ram 1500 Quad Cab 6.4'	R50083
09-12	Ram 1500 Reg. Cab	R50083
02-08	Ram 1500 (Exc. Mega cab)	R50040
10-12	Ram 2500/3500 HD (Exc. model w/gas engine or overload spring)	D50140
06-08	Ram 1500 Mega Cab 6'	D50140
03-12	Ram 2500/3500 HD (Exc. Mega Cab & model with overload spring)	R50040
03-09	Ram 2500/3500 HD	D50140
FORD		
99-10	F250/350 SD	R50082
04-13	F150	R50081
11-13	F250/350/450 (not Cab & Chassis)	R50073
TOYOTA		
07-13	Tundra	R50084

ADAPTEURS POUR RAILS / ADAPTER BRACKETS FOR RAILS



DODGE / RAM		
2013	Ram 1500 Crew Cab 5.7' (Pour rails/For rails: R30035)	R58386
09-12	Ram 1500 (Inc. Mega Cab) (Pour rails/For rails: R30035)	R58386
09-12	Ram 1500 (Exc. Crew Cab) (Pour rails/For rails: R30095)	R58433
02-08	Ram 1500 (Exc. Mega Cab) (Pour rails/For rails: R30095)	R58432
03-12	Ram 2500/3500 HD (With overload spring)	R58186
FORD		
04-13	F150 All (Pour rails/For rails: R30035 & R30095)	R58426
05-13	F250/350 Super Duty (Pour rails/For rails: R30095)	R58425
08-13	F450 Super Duty (Exc. cab & chassis) (Pour rails/For rails: R30095)	R58425
NISSAN		
04-12	Titan Crew / King Cab (Pour rails/For rails: R30035)	R58405
TOYOTA		
07-13	Tundra (Pour rails/For rails: R30035)	R58309



MAINS / GOOSENECKS



0287600300
Cap.: 20,000 lb
Ajustable/Adjustable
2 5/16" boules/balls
Tube rond / round tube



1289030300
Cap.: 20,000 lb
Ajustable/Adjustable
2 5/16" boules/balls
Tube rond / round tube



0287760300
Cap.: 24,000 lb
Ajustable/Adjustable
2 5/16" boules/balls
Tube rond / round tube



0289600300
Cap.: 25,000 lb
Ajustable/Adjustable
2 5/16" boules/balls
Tube carré / square tube



1289020300
Cap.: 25,000 lb
Ajustable/Adjustable
2 5/16" boules/balls
Tube rond / round tube



0289500300
Cap.: 30,000 lb
Ajustable/Adjustable
2 5/16" boules/balls
Tube rond / round tube



1289040300
Cap.: 30,000 lb
Ajustable/Adjustable
2 5/16" boules/balls
Tube rond / round tube



1289050300
Cap.: 30,000 lb
Ajustable/Adjustable
2 5/16" boules/balls
Tube rond / round tube

REESE®

FIFTH GEAR



**UNE CONDUITE PLUS DOUCE.
POUR UN VIRAGE EXTRÊME.
SMOOTHER RIDE.
EASIER TURNING.**

SIDEWINDER

- Capacité / Capacity : 16,000 lb



R61410

STANDARD
Fabex 520, 530 & 560.
Lippert 1116 & 0115. RBW 7019
EXTENDED
Fabex 500, 503 & 765.
Lippert 1716. RBW 7028

R61420

STANDARD
Fabex 663. M&M 663. Lippert 0719
EXTENDED
Fabex 665. M&M 665. Lippert 1621
& 1621 HD

ELITE AIRBORNE/SIDEWINDER

- Capacité / Capacity : 16,000 lb
- Combinaison / Combination of 5th AIRBORNE et SIDEWINDER



STANDARD

Fabex 663. M&M 663. Lippert 0719
EXTENDED
Fabex 665. M&M 665. Lippert 1621
& 1621HD.

R61422

5th AIRBORNE SIDEWINDER

- Capacité / Capacity : 19,500 lb
- Combinaison / Combination of 5th AIRBORNE et SIDEWINDER



R61423

5th AIRBORNE

STANDARD
Fabex 663. M&M 663.
Lippert 0719
EXTENDED
Fabex 665. M&M 665.
Lippert 1621 & 1621HD.



5th AIRBORNE

- Capacité / Capacity : 21,000 lb
- Réduction choc horizontal de 60%. Contrôle du choc vertical 44%.
- "Anti-chucking" horizontal less 60%. Shock control vertical less 44%.

5th AIRBORNE



R5ABE1621610

EXTENDED

Fabex 665. M&M 665.
Lippert 1621HD

COL-DE-CYGNE • ELITE SERIES • GOOSENECK HITCH



25,000 lb / 6,250 lb

R30138-26

Complete Hitch

FORD - 11-13 F250/350/450 Super Duty
will not fit Cab and Chassis



25,000 lb / 6,250 lb

R30158-68

Attelage complet / Complete Hitch

CHEVROLET / GMC

11-13 Sierra / Silverado 2500/3500 HD, 6.5' & 8',
2 & 4 WD

GMC - 11-13 Sierra Denali HD, 6.5', 2 & 4 WD



25,000 lb / 6,250 lb

R30158-52

Attelage complet / Complete Hitch

DODGE / RAM

10-12 Ram 2500 HD Inc. Mega Cab 2 & 4 WD
10-12 Ram 3500 HD Inc. Mega Cab & Dually 2 & 4

ATTELAGES COL-DE-CYGNE / GOOSENECK HITCHES

ATTELAGES 5° ROUE / 5° WHEEL HITCHES



R58079

25,000 lb / 6,250 lb

Nécessite rails et ens. d'installation
R30035 ou R30095 (Vendu séparément)

Use with rail and installation kit
R30035 or R30095 (Sold separately)



R49080

25,000 lb / 6,250 lb

Nécessite rails et ens. d'installation
R30035 ou R30095 (Vendu séparément)

Use with rail and installation kit
R30035 or R30095 (Sold separately)

COL-DE-CYGNE DE DESSUS DE CAISSE ABOVE-BED GOOSENECK ELITE SERIES



R30845

30,000 lb / 7,500 lb

Série 30K ELITE / ELITE 30K Series

PIÈCES DE RECHANGE / REPLACEMENT PARTS



R30136

Couvercle pour ELITE
Col-de-cygne
de dessous de caisse
Hole Cover for ELITE
Underbed gooseneck Hitch



R30134

Fixation de chaîne de sécurité
pour ELITE Col-de-cygne
de dessous de caisse
Safety chain Attachment
for ELITE Underbed gooseneck Hitch



R58468

2 fixations de
chaîne de sécurité
2 Safety chain
Attachments



R19311

Boule de rechange 2 5/16"
pour ELITE Col-de-cygne
de dessous de caisse
2 5/16" Pop-In Ball for ELITE
Underbed gooseneck Hitch

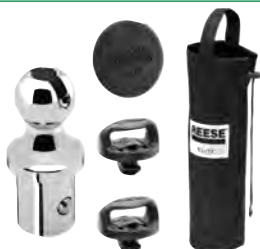

R30137

Trousse d'accessoires pour ELITE
Col-de-cygne de dessous de caisse
Inclus : boule de rechange 2 5/16", sac de rangement,
fixation de chaîne de sécurité et couvercle.
Accessories Kit for ELITE Underbed gooseneck Hitch
Includes: 2 5/16" Pop-In Ball, Storage Bag,
Safety chain attachment and Hole Cover.

RAM



PIVOT D'ACCOUPLMENT FORGÉ FORGED TRAILER KING PIN

KP5G-R25

Capacité/Capacity:
25,000 lb

Ajustable incluant plateau
Adjustable including
bolster plate



KP20038

2"
0.38" d'épaisseur
0.38" thickness



KING PIN PROLONGÉ KING PIN EXTENDER

PUIRV5

10" d'espace, 24,000 lb poids remorque,
6,000 lb à la verticale
10" clearance, 24,000 lb trailer weight,
6,000 lb tongue weight



MAIN / GOOSENECK

D028782030

Capacité/Capacity:
25,000 lb.

Boule/Ball: 2 5/16"
Ajustable/Adjustable
Tube rond/Round tube



PLATEFORME D'ATTELAGE RABATTABLE / FOLD-DOWN GOOSENECK HITCH PLATFORM

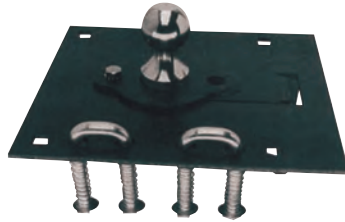

G9003

25,000 lbs - 5,000 lbs

Attelage "Gooseneck" rétractable. Plateforme avec boule 2 5/16" rétractable avec couvert
Retractable Gooseneck. Platform with removable 2 5/16" ball and cover

BRB03

Ens. de U-Bolt pour chaîne de sécurité
Safety chain U-bolt kit



**PLATEFORME D'ATTELAGE RABATTABLE
 FOLD-DOWN GOOSENECK HITCH PLATFORM**



D8339

25,000 lbs • 6,250 lbs
 Plateforme d'attelage rabattable
 avec boule 2 5/16"
*Fold-down gooseneck hitch
 platform with 2 5/16" ball*



D6300

30,000 lbs • 7,500 lbs
 Plateforme avec boule 2 5/16" amovible
 et couvert magnétique
*Platform with removable 2 5/16" ball
 and magnetic cover*



D5973

Boule de remplacement 2 5/16"
 (Pour: **D6300**)
*2 5/16" replacement ball
 (For: **D6300**)*

**ENSEMBLE DE RAILS
 RAIL KIT**



D4456

Ensemble de rails/Rail kit
 (Pour/for: **D6300** & **D8389**)
CHEVROLET / GMC 2500/3500 HD 11-13

R4457

Ensemble de rails/Rail kit
 (Pour/for: **D6300** & **D8389**)
RAM 2500 HD 10-13 / RAM 3500 HD 10-12

ATTELAGE COL-DE-CYGNE (COMPLET) • HIDE-A-GOOSE • GOOSENECK HITCH (COMPLETE)

30,000 lbs - 7,500 lbs • Boule/Ball: 2 5/16"

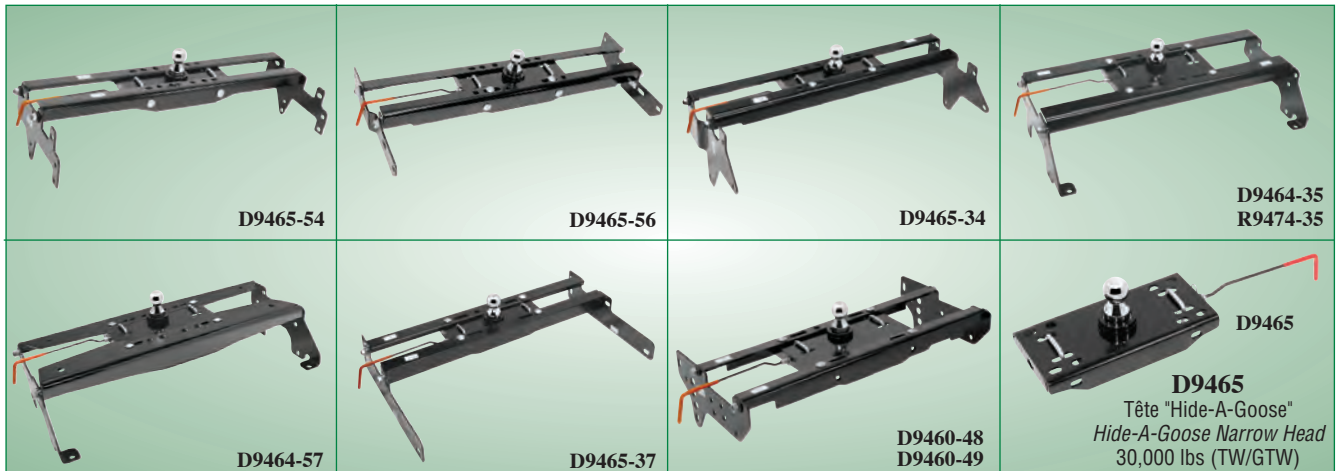

CHEVROLET / GMC	
01-07 Silverado/Sierra 1500 HD Classic 6.5', 2 & 4 WD	D9465-54
99-13 Silverado/Sierra 1500 LD/HD 6.5' & 8', 2 & 4 WD	D9465-54
99-04 Silverado/Sierra 2500 LD 6.5', 2 & 4 WD	D9465-54
11-13 Silverado/Sierra 2500/3500 HD 6.5' & 8', 2 & 4 WD	D9465-56
99-04 Silverado/Sierra 2500 LD	D9465-34
01-10 Silverado/Sierra 2500/3500 HD	D9465-34
DODGE / RAM	
06-08 Ram 1500 Mega Cab 6.5'	R9474-35

DODGE / RAM (Cont.)	
03-12 Ram 2500/3500 HD	D9464-35
10-13 Ram 2500 HD	D9464-57
10-12 Ram 3500 HD	D9464-57
FORD	
04-13 F150 Reg. & Super Cab not Heritage	D9465-37
04-13 F150 Super Crew 6.5'	D9465-37
99-13 F250/350 SD not Cab & Chassis	D9460-48
08-13 F450 SD not Cab & Chassis	D9460-49



Demco



Fabriqué aux États-Unis
Made in USA

ATTELAGES 5^E ROUE / 5TH WHEEL HITCHES

INSTALLATION SOUS LA BOÎTE DU CAMION / UNDER BED MOUNT

Autoslide

HIJACKER

Tête pivotante double avec glissière de verrouillage positive en acier solid 3/4".
Double pivot head with 3/4" solid steel.

Glissière qui utilise un engrenage à pignon et crémaillère.
Slides utilizing rack and pinion gear technology.

Jusqu'à 14" de course
Up to 14" of travel

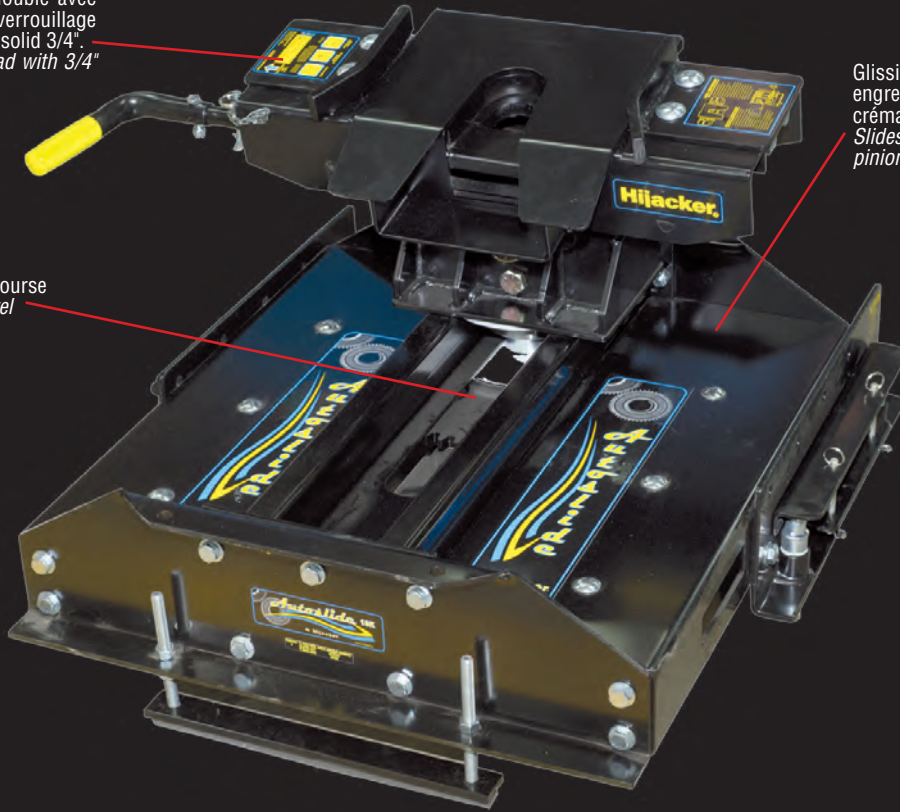

- Application pour boîte courte
- Glissière qui utilise un engrenage à pignon et crémaillère
- Trois réglages de hauteur verticale pour vous aider à niveler le camion et la remorque
- Revêtement par poudre pour une longue durée et une finition durable
- Jusqu'à 14" de course
- Tête pivotante double avec glissière de verrouillage positive en acier solid 3/4"

- Short Box Application
- Slides utilizing rack and pinion gear technology
- Three vertical height adjustments to help you level the truck and trailer
- Powder coated for long lasting, durable finish
- Up to 14" of travel
- Double pivot head with 3/4" solid steel, positive locking slide bar

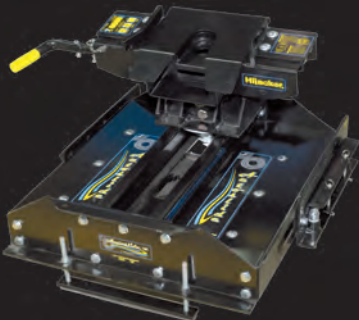

HJ8550001
18,000 lbs



HJ8550017
18,000 lbs • Pour/For: **FORD**

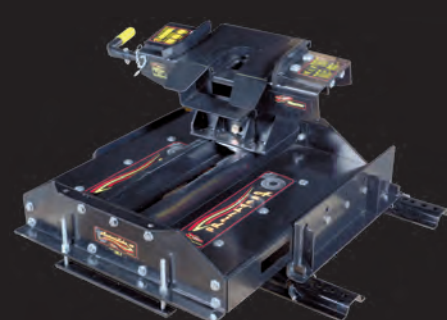

HJ8550002
18,000 lbs • Série ULTRA Series
Installation au dessus de la boîte de camion / Above bed mount

Protecteur de rebord inclus. Support de montage pour cadre doit être commandé séparément / Bed rails included. Frame mounting brackets must be ordered separately.



Demco







Fabriqué aux États-Unis
Made in USA

ATTELAGES 5^e ROUE / 5th WHEEL HITCHES

HIJACKER

Garantie de 5 ans
5 year warranty

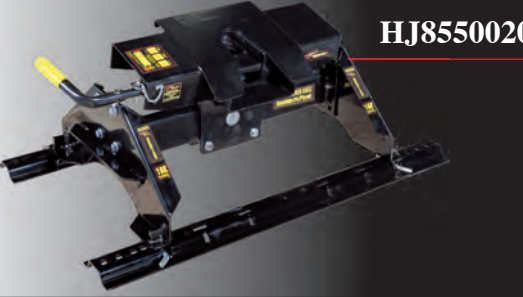
• PREMIER SERIES •

	Description	Capacité lbs Capacity lbs
 <p>HJ8550019</p>	<ul style="list-style-type: none"> • Application pour boîte courte / <i>Short box application</i> • Tête pivotante double avec butoir en polyuréthane <i>Double pivot head with polyurethane bumpers</i> • Protecteur de rebord inclus / <i>Bed rail included</i> • Boulon unique de réglage qui réduit le bruit et le jeu <i>Unique Jaw adjustment bolt that reduces noise and play</i> • Acier solide 3/4", glissière de verrouillage positive pour branchement facile et sûr <i>3/4" solid steel, positive locking slide bar for easy and secure hook-up</i> • Quatre réglages de hauteur verticale pour vous aider à niveler le camion et la remorque <i>Four vertical height adjustments to help you level the truck and trailer</i> • Rouleaux en acier inoxydable / <i>Stainless steel rollers</i> • Jusqu'à 8" de course / <i>Up to 8" of travel</i> • Support de montage pour cadre doit être commandé séparément <i>Frame mounting brackets must be ordered separately</i> 	16,000
 <p>HJ8550018</p>	<ul style="list-style-type: none"> • Application pour boîte courte / <i>Long box application</i> • Tête pivotante double avec butoir en polyuréthane <i>Double pivot head with polyurethane bumpers</i> • Protecteur de rebord inclus / <i>Bed rail included</i> • Boulon unique de réglage qui réduit le bruit et le jeu <i>Unique Jaw adjustment bolt that reduces noise and play</i> • Acier solide 3/4", glissière de verrouillage positive pour branchement facile et sûr <i>3/4" solid steel, positive locking slide bar for easy and secure hook-up</i> • Quatre réglages de hauteur verticale pour vous aider à niveler le camion et la remorque <i>Four vertical height adjustments to help you level the truck and trailer</i> 	16,000
 <p>HJ8550020</p>	<ul style="list-style-type: none"> • Application pour boîte courte / <i>Long box application</i> • Tête pivotante double avec butoir en polyuréthane <i>Double pivot head with polyurethane bumpers</i> • Protecteur de rebord inclus / <i>Bed rail included</i> • Boulon unique de réglage qui réduit le bruit et le jeu <i>Unique Jaw adjustment bolt that reduces noise and play</i> • Acier solide 3/4", glissière de verrouillage positive pour branchement facile et sûr <i>3/4" solid steel, positive locking slide bar for easy and secure hook-up</i> • Quatre réglages de hauteur verticale pour vous aider à niveler le camion et la remorque <i>Four vertical height adjustments to help you level the truck and trailer</i> 	21,000
 <p>HJ8550021</p>	<ul style="list-style-type: none"> • Application pour boîte courte / <i>Short box application</i> • Tête pivotante double avec butoir en polyuréthane <i>Double pivot head with polyurethane bumpers</i> • Protecteur de rebord inclus / <i>Bed rail included</i> • Boulon unique de réglage qui réduit le bruit et le jeu <i>Unique Jaw adjustment bolt that reduces noise and play</i> • Acier solide 3/4", glissière de verrouillage positive pour branchement facile et sûr <i>3/4" solid steel, positive locking slide bar for easy and secure hook-up</i> • Quatre réglages de hauteur verticale pour vous aider à niveler le camion et la remorque <i>Four vertical height adjustments to help you level the truck and trailer</i> • Rouleaux en acier inoxydable / <i>Stainless steel rollers</i> • Jusqu'à 8" de course / <i>Up to 8" of travel</i> • Support de montage pour cadre doit être commandé séparément <i>Frame mounting brackets must be ordered separately</i> 	21,000



Demco



Fabriqué aux États-Unis
Made in USA

ATTELAGES 5^e ROUE / 5th WHEEL HITCHES

HIJACKER

Garantie de 5 ans
5 year warranty

• SL SERIES •

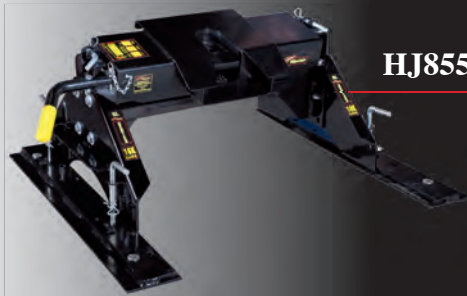

HJ8550008

Description

Capacité lbs
Capacity lbs

- Application pour boîte Longue/courte / *Long/Short box application*
- **Tête pivotante simple / *Single pivot head***
- Protecteur de rebord inclus / *Bed rail included*
- Boulon unique de réglage qui réduit le bruit et le jeu
Unique Jaw adjustment bolt that reduces noise and play
- Quatre réglages de hauteur verticale pour vous aider à niveler le camion et la remorque
Four vertical height adjustments to help you level the truck and trailer

16,000



HJ8550009

Description

Capacité lbs
Capacity lbs

- Application pour boîte Longue/courte / *Long/Short box application*
- **Tête pivotante double / *Double pivot head***
- Protecteur de rebord inclus / *Bed rail included*
- Boulon unique de réglage qui réduit le bruit et le jeu
Unique Jaw adjustment bolt that reduces noise and play
- Quatre réglages de hauteur verticale pour vous aider à niveler le camion et la remorque
Four vertical height adjustments to help you level the truck and trailer

16,000



HJ8550015

Description

Capacité lbs
Capacity lbs

- Application pour boîte Longue/courte / *Long/Short box application*
- **Tête pivotante double / *Double pivot head***
- Protecteur de rebord inclus / *Bed rail included*
- Boulon unique de réglage qui réduit le bruit et le jeu
Unique Jaw adjustment bolt that reduces noise and play
- Quatre réglages de hauteur verticale pour vous aider à niveler le camion et la remorque
Four vertical height adjustments to help you level the truck and trailer

21,000

Garantie de 5 ans
5 year warranty

• UMS SERIES •



HJ8550003
21,000 lbs

HJ8550016
21,000 lbs
Pour/For: Ford

- Installation sous la boîte du camion / *Under bed mounting system*
- Bouchon pour boîte de camion d'inclus / *Bed hole plugs included*
- Application pour boîte Longue / *Long box application*
- **Tête pivotante double / *Double pivot head***
- Protecteur de rebord inclus / *Bed rail included*
- Boulon unique de réglage qui réduit le bruit et le jeu
Unique Jaw adjustment bolt that reduces noise and play
- Revêtement par poudre pour une longue durée et une finition durable
Powder coated for long lasting, durable finish
- Installation rapide et facile / *Quick and easy installation*



Demco



Fabriqué aux États-Unis
Made in USA

ENSEMBLES DE SUPPORT DE MONTAGE / FRAME MOUNTING BRACKET KITS

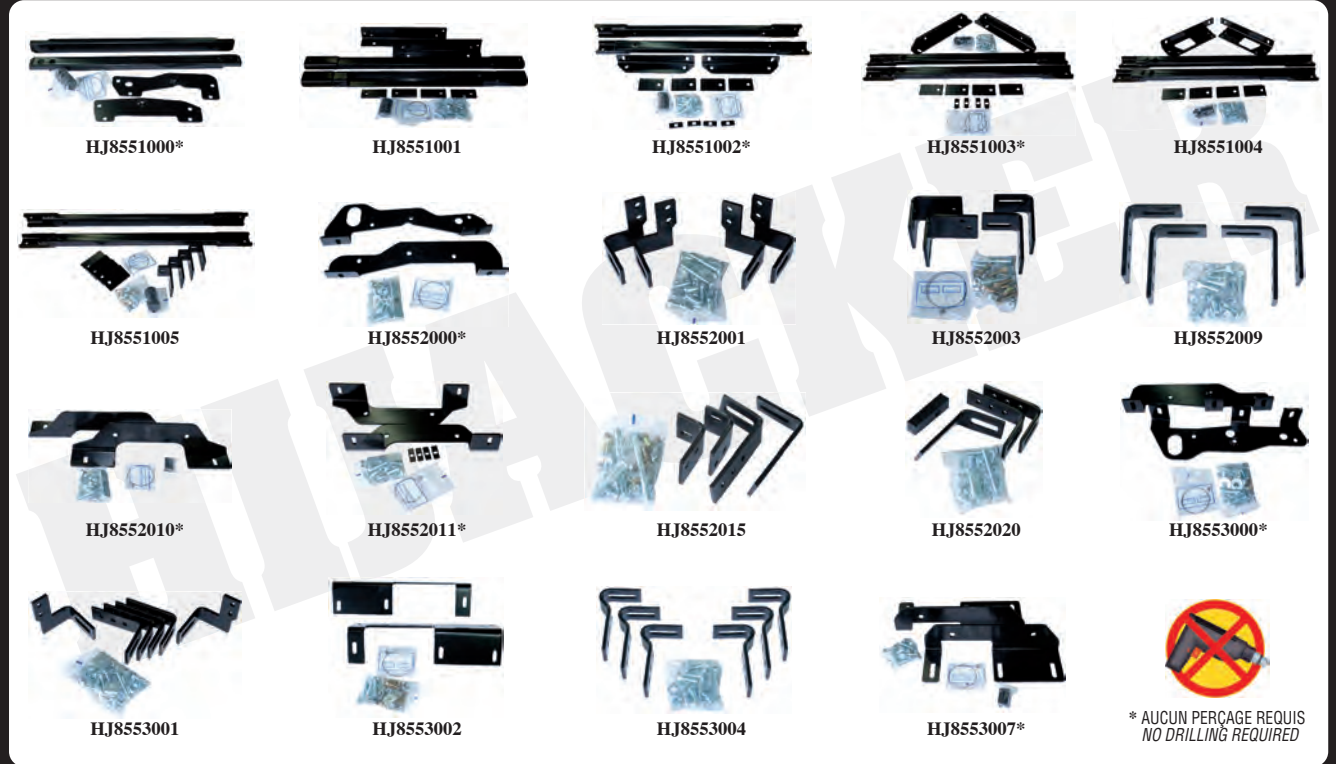

	Séries UMS (Installation sous la boîte) UMS Series (Under bed mount)	Séries Ultra ULTRA Series	Séries SL (Tête 24" seulement) SL Series (24" head only)
CHEVROLET / GMC			
07-13 Silverado/Sierra 1500 6.5' (Tube frame)	HJ8551005	HJ8552009	HJ8553004
01-07 Silverado/Sierra 1500 HD Classic 6.5' & 8'	HJ8551004	---	HJ8553004
99-07 Silverado/Sierra 1500/2500 Classic 6.5' & 8'	HJ8551004	---	HJ8553004
11-13 Silverado/Sierra 2500/3500 HD 6.5'	HJ8551002*	HJ8552010*	HJ8553007*
11-13 Silverado/Sierra 2500/3500 HD 8'	HJ8551003*	HJ8552011*	HJ8553007*
01-10 Silverado/Sierra 2500/3500 HD 6.5' & 8'	HJ8551004	HJ8552009	HJ8553004
DODGE / RAM			
02-08 Ram 1500 (4x2, 4x4) 6.5' & 8' (Incl. Mega Cab)	HJ8551005	HJ8552015	HJ8553004
03-12 Ram 2500 (4x2, 4x4) 6.5' & 8' (Incl. Mega Cab)	HJ8551005	HJ8552015	HJ8553004
03-12 Ram 3500 (4x4 only) 6.5' & 8' (Incl. Mega Cab)	HJ8551005	HJ8552015	HJ8553004
03-12 Ram 3500 (4x2 only) 6.5' & 8' (Incl. Mega Cab)	HJ8551005	---	HJ8553004
FORD			
04-13 F150 SD 6.5' & 8' (not for 5.5' box installs)	HJ8551001	HJ8552003	HJ8553002
97-03 F150 6.5' & 8'	---	---	HJ8553004
11-12 F250/350 SD	HJ8551000*	HJ8552000*	HJ8553000*
05-10 F250/350 SD	HJ8551000*	HJ8552001	HJ8553001
99-04 F250/350 SD 6.5' & 8'	HJ8551000*	---	---
97-99 F250 LD 6.5' & 8'	---	---	HJ8553004
11-12 F450 SD 6.5' & 8'	HJ8551000*	HJ8552000*	HJ8553000*
08-10 F450 SD 6.5' & 8'	HJ8551000*	HJ8552001	HJ8553001
TOYOTA			
07-13 Tundra 6.5' & 8'	---	HJ8552020	---



THE ORIGINAL
Equal-i-zer
SWAY CONTROL HITCH



**ATTELAGE CONTRÔLEUR DE BALANCEMENT
SWAY CONTROL HITCH
BOULE 2" / 2" BALL**



90-00-0601
6,000 lb GTW

90-00-1001
10,000 lb GTW

90-00-1201
12,000 lb GTW



CONTRÔLEUR DE BALANCEMENT / SWAY CONTROL

Peut être utilisé sur le côté gauche ou droit de la remorque / Can be used on left or right side of trailer



R83660
Ens. complet
Complete kit

RP RP



D3400
Ens. complet
Complete kit

**PIÈCES DE RECHANGE
REPLACEMENT PARTS**



D3442
Plaque pour boule
Ball mounting bar



D58060
Boule / Ball
1 1/4" x 5/8"

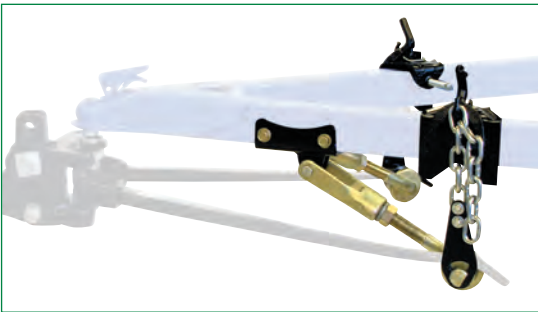

R26002
Double Cam HP / Dual Cam HP



R26025
Double Cam HP classique / Dual Cam HP Classic



**ENS. DE DISTRIBUTION DE POIDS
ROUND BAR WEIGHT DISTRIBUTION KIT**



D49581
550 lbs. TW
10,000 lbs. GTW

D49582
750 lbs. TW
10,000 lbs. GTW

D49583
1,000 lbs. TW
10,000 lbs. GTW

- Inclut:
- Distributeur de poids
 - Chaines
 - Supports

- Includes:
- Weight distributor
 - Chains
 - Brackets

**ENS. COMPLET DE DISTRIBUTION DE POIDS
COMPLETE ROUND BAR WEIGHT DISTRIBUTION KIT**



R49901
550 lbs. TW
10,000 lbs. GTW

R49902
750 lbs. TW
10,000 lbs. GTW

R49903
1,000 lbs. TW
10,000 lbs. GTW

- Inclut:
- Contrôle de balancement
 - Distributeur de poids
 - Chaines et supports

- Includes:
- Sway control
 - Weight distributor
 - Chains and brackets

ENS. DE DISTRIBUTION DE POIDS / WEIGHT DISTRIBUTING KITS

Tête moulée une pièce. Support ajustable inclus. Type "trunnion".
One piece cast head. Adjustable shank included "Trunnion style".

Support ajustable inclus. Type "trunnion". Boule vendu séparément.
Adjustable shank included "Trunnion style". Ball sold separately.



R66151
10,000 / 600 lb

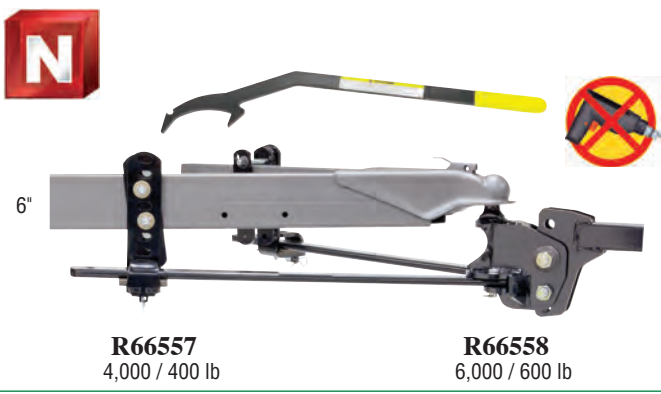

R66557
4,000 / 400 lb

R66558
6,000 / 600 lb

Ajustable. Plateforme de boule élevée et forgée. Rondelle striée.
Adjustable. Forged raised ball platform and forged trunnion mounts. Serrated washer

Rondelle ajustable. Tête moulée une pièce. Support ajustable inclus.
Adjusting washer. One piece cast head. Adjustable shank included.

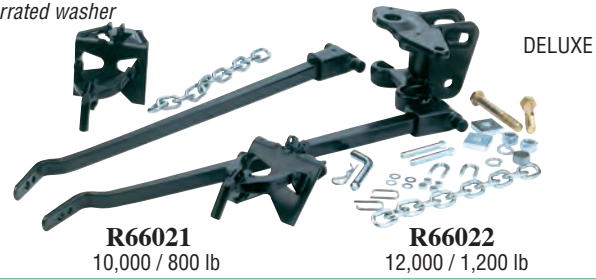

R66021
10,000 / 800 lb

R66022
12,000 / 1,200 lb



R65509
10,000/600 lb

R67509
10,000/800 lb

R61009
12,000/1,200 lb



R66024
3,500 / 350 lb
Avec boule 2" / With 2" ball

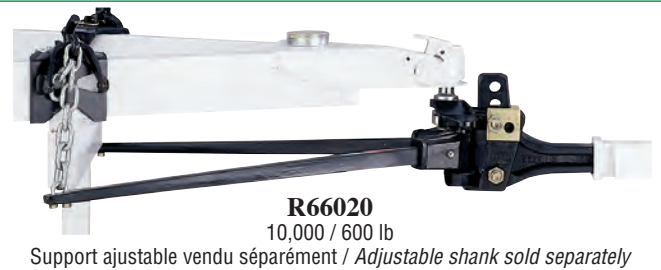

R66020
10,000 / 600 lb
Support ajustable vendu séparément / Adjustable shank sold separately

Tête moulée une pièce. Support ajustable inclus.
N'accepte pas R26002. Adjusting washer. One piece cast head. Adjustable shank included. Does not accept R26002.

Tête moulée une pièce. Support ajustable inclus.
Type "trunnion". Adjusting washer. Adjustable shank included "Trunnion style".

Barre à boulonner de type "trunnion".
Trunnion bar bolt-together.



R49568
10,000 / 600 lb

R49569
10,000 / 800 lb

R49570
12,000 / 1,200 lb



R49585
10,000 / 600 lb

R49587
12,000 / 1,200 lb

R49586
10,000 lb GTW
800 lb max TW



R66006
17,000 lb GTW
1,700 lb max TW

**BARRE DE REMORQUAGE AJUSTABLE
 ADJUSTABLE TOW BAR**



D63180
5,000 lb. Noir / Black.

**BARRE DE REMORQUAGE AJUSTABLE
 ADJUSTABLE TOW BAR**



MXV60601
5,000 lb





CROCHETS D'ATTELAGE / PINTLE HOOKS

Ens. de montage **non** inclus. Nécessite **B9020**
Mounting kit not included. Needs B9020



PH5
Ens. de montage **non** inclus. Nécessite **B9020**
Mounting kit not included. Needs B9020
Timon : 2,000 lb TW
Capacité / Capacity : 10,000 lb GTW



PH15
Ens. de montage **non** inclus. Nécessite **B9020**.
Mounting kit not included. Needs B9020
Timon : 6,000 lb TW
Capacité / Capacity : 30,000 lb GTW

ANNEAUX SUR PLAQUE FORGÉ FORGED PINTLE RINGS WITH PLATE

Ens. de montage **non** inclus. Nécessite **B9020** / *Mounting kit not included. Needs B9020*

BH82000

- Timon : 3,000 lb TW
- Capacité / Capacity : 16,000 lb GTW
- Boule chromée / Chromed ball : 2"

BH82516

- Timon : 3,000 lb TW
- Capacité / Capacity : 16,000 lb GTW
- Boule chromée / Chromed ball : 2 5/16"



BDB125015
• 2 1/2" dia. intérieur/interior
• Timon : 7,000 lb TW
• Capacité / Capacity : 42,000 lb GTW



BDB1385
• 3" dia. intérieur/interior
• Timon : 15,000 lb TW
• Capacité / Capacity : 60,000 lb GTW

ANNEAU AJUSTABLE SEUL ADJUSTABLE EYE ONLY



MXV16137
Anneau 3"
3" Adjustable eye
12,000 lb

SUPPORTS AJUSTABLE ADJUSTABLE CHANNELS



MXV8979
Support ajustable
Adjustable channel
5 positions
7.25 lb

MXV8978
Support ajustable
Adjustable channel
3 positions
3.8 lb



CROCHETS D'ATTELAGE / PINTLE HOOKS



PH5WMK
Ens. de montage inclus / *Mounting kit included*
Timon : 2,000 lb TW
Capacité / Capacity : 10,000 lb GTW



PH8
Ens. de montage **non** inclus. Nécessite **B9020**
Mounting kit not included. Needs B9020
Timon : 3,200 lb TW
Capacité / Capacity : 16,000 lb GTW



PH15WMK
Ens. de montage inclus / *Mounting kit included*
Timon : 6,000 lb TW
Capacité / Capacity : 30,000 lb GTW

ANNEAU DE REMORQUE FORGÉ AVEC ÉCROU FORGED TOWING RING WITH NUT



BDB12503
2 1/2" dia. intérieur
2 1/2" dia. interior
7.5 Ton



ANNEAU DE REMORQUE FORGÉ FORGED TOWING RING

LW10
2 1/2" dia. intérieur / interior
Timon : 1,000 lb TW
Capacité / Capacity : 10,000 lb GTW



B9020
Ens. de noix et de
boulons (2 ch.)
Bolt & nut kit (2 ea.)
1lb



**TÊTE D'ASSEMBLAGE
HEAD ASSEMBLY**



R58167
1,000 lb
Standard

**LANGUETTES DE RETENUE
SPRING BAR RETAINERS**

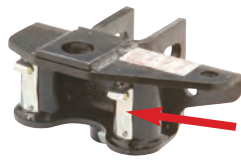

D3311

**SUPPORT D'ATTACHE
HOOK-UP BRACKET**



R21501
Vendu à l'unité
Sold per unit



R55180
Pivot de sécurité
pour R21501.
Safety pin for
R21501.

SUPPORTS AJUSTABLES • 2" x 2" • ADJUSTABLE SHANKS

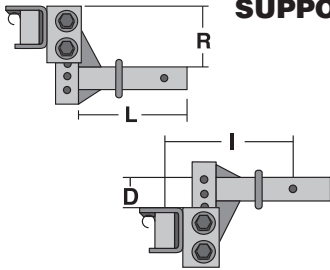

D3210
14,000/1,400 lb
L: 10"

with round bar
I: 12 1/2"
D: 2 1/4"
R: 5 3/4"

with trunnion bar
I: 11 7/8"
D: 1 1/4"
R: 7"



D3215
14,000/1,400 lb
L: 11"

with round bar
I: 13 1/2"
D: 6 3/4"
R: 10 1/4"

with trunnion bar
I: 12 7/8"
D: 5 3/4"
R: 11 1/2"



R54998
16,000/1,600 lb
L: 12 1/4"

with round bar
I: 14 3/4"
D: 4 1/8"
R: 7 3/8"

with trunnion bar
I: 14"
D: 3 3/8"
R: 8 5/8"



R54970
15,000/1,500 lb
L: 12 1/4"

with round bar
I: 14 3/4"
D: 2"
R: 5 1/4"

with trunnion bar
I: 14"
D: 1 1/4"
R: 6 1/2"



D63971
15,000/1,500 lb
L: 12 1/2"

with round bar
I: 15"
D: 6 1/2"
R: --

with trunnion bar
I: 14 3/8"
D: 5 3/4"
R: --

SUPPORTS DE MONTAGE • 2" x 2" • PINTLE HOOK MOUNTS



R63056
• 16,000/6,000 lb
• 3 trous/holes, 2 positions

A 7 1/2" B 4 7/8" C 6" D 3 3/8" E 1 3/4"

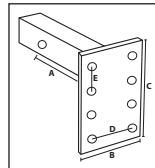

R63057
• 12,000/1,200 lb
• 4 trous/holes, 3 positions

A 6 1/2" B 4 7/8" C 7 1/4" D 3 3/8" E 1 3/4"



PM105
• 14,000/2,800 lb
• 3 trous/holes, 2 positions

Trous/Holes : (Plein/Solid)
A 7 1/2" B 4 7/8" C 6" D 3 3/8" E 1 3/4"

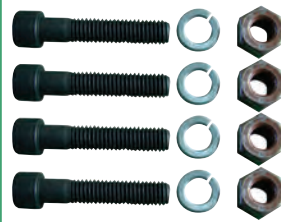

**BOULONS DE MONTAGE
POUR CROCHET D'ATTELAGE
PINTLE MOUNTING KIT**

HH63032



SUPPORTS DE MONTAGE • 2" x 2" • PINTLE HOOK MOUNTS

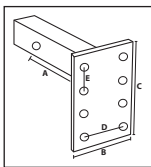

PM87
• 10,000/2,000 lb
• Barre / Bar: 9 1/4"
• 4 trous/holes, 3 positions

A 5 3/4" B 4 7/8" C 7 1/2" D 3 3/8" E 1 3/4"

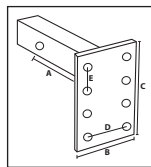

PM812
• 10,000/2,000 lb
• Barre / Bar: 12 3/4"
• 7 trous/holes, 6 positions

A 9" B 4 7/8" C 12 1/2" D 3 3/8" E 1 3/4"

**BARRE DE TIRE AJUSTABLE
ADJUSTABLE BALL MOUNT**

Pour / For : 2" x 2"

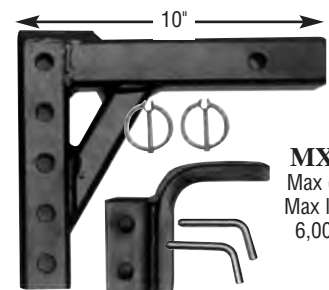

MXV7001
Max drop : 11"
Max lift : 9 3/4"
6,000/600 lb



CROCHETS D'ATTELAGE / PINTLE HOOKS



D63010
 Ens. de montage inclus
Mounting kit included
 • Capacité/Capacity: 16,000 lb GTW
 • 3,000 lb TW
 • Boule chromée / Chromed ball:
 1 7/8" • 6,000 lb



D63015
 Ens. de montage inclus
Mounting kit included
 • Timon: 6,000 lb TW
 • Capacité/Capacity:
 30,000 lb GTW



D63014
 Ens. de montage inclus
Mounting kit included
 • Timon: 4,000 lb TW
 • Capacité/Capacity:
 20,000 lb GTW



D63011
 Ens. de montage inclus
Mounting kit included
 • Capacité/Capacity:
 16,000 lb GTW
 • 3,000 lb TW
 • Boule chromée
Chromed ball:
 2" • 10,000 lb



D63013
 Ens. de montage inclus
Mounting kit included
 • Timon: 2,000 lb TW
 • Capacité/Capacity:
 10,000 lb GTW



2" x 2"

Ens. de montage inclus
Mounting kit included
HH63041
 Capacité/Capacity:
 12,000 lb / 2,400 lb TW
 Boule chromée / Chromed ball:
 2" • 7,000 lb



**ALIGNEUR DE REMORQUE
 TRAILER HITCH ALIGNER**

D63300

- Base Magnétique pour localisation rapide
- Tige télescopique jusqu'à 42"
- Magnetic base for fast and easy location
- Telescoping rods adjust up to 42"



**ATTELAGE POUR PARE-CHOC À MARCHÉ
 STEP BUMPER HITCH**



SBH2
 2" x 2" • 3500 / 350 lbs



**MAINS D'ACCOUPLÉMENT
 AJUSTABLES
 ADJUSTABLE COUPLERS**

B0090150
 2" • 10,000 lb
 Noir / Black

0090100
 2 5/16" • 12,000 lb
 Zinc



**MAIN D'ACCOUPLÉMENT AJUSTABLE
 ADJUSTABLE COUPLER**

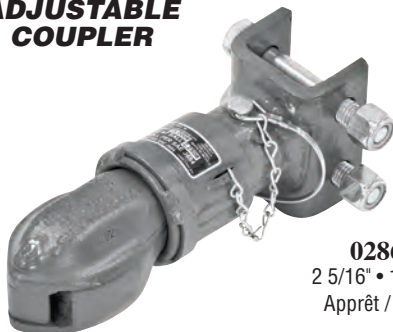

028657
 2 5/16" • 10,000 lb
 Apprêt / Primed

**MAIN D'ACCOUPLÉMENT POUR MAIN
 GOOSENECK COUPLER**



0287740300
 20,000 lb
 Comprend coupler,
 goupille à attache,
 couvert pour goupille
 à attache.
*Includes coupler,
 locking pin assembly,
 locking pin cover.*

RAM

MAINS D'ACCOUPEMENT / COUPLERS



	Boule Ball	Timon Tongue mount	Finition Finish	Capacité Capacity
CT-2001-Z	1 7/8"	2"	Zinc	2,000 lb
CT-3001-Z	2"	2"	Zinc	3,500 lb
CT-3002-Z	2"	2 1/2"	Zinc	3,500 lb
CT-3003-Z	2"	3"	Zinc	3,500 lb



	Boule Ball	Timon Tongue mount	Finition Finish	Modèle Model	Capacité Capacity
CA-5100-O	2"	"A" Frame	Huileux/Oily	1	5,000 lb
CA-5200-O	2 5/16"	"A" Frame	Huileux/Oily	2	10,000 lb
CA-5400-O	2 5/16"	"A" Frame	Huileux/Oily	2	14,000 lb



AJUSTABLE / ADJUSTABLE



CTA-400
 Capacité / Capacity: 14,000 lb
 Boule / Ball: 2 5/16"
 Revêtement en poudre noir / Black powder



MAINS D'ACCOUPEMENT / COUPLERS

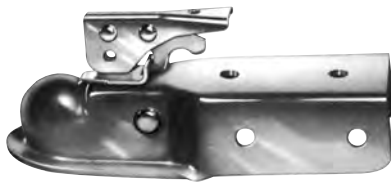

Boule Ball	Classe Class	Capacité Capacity	Pôle (Timon) Tongue mount	ZINC ZINC	HUILEUX OILY	SÉRIE ÉCONOMIQUE VALUE SERIES
1 7/8"	I	2000 lb	2"	---	---	E112000340
1 7/8"	I	2000 lb	2 1/2"	---	---	E112500340
1 7/8"	I	2000 lb	3"	---	---	E113000340
2"	II	3500 lb	2"	222000301	---	---
2"	II	3500 lb	2 1/2"	222500301	222500317	---
2"	II	3500 lb	3"	223000301	---	---
2"	III	3500 lb	3"	BUT290071	---	---
2"	III	5000 lb	3"	343000301	---	---
2"	III	5000 lb	A-FRAME	---	---	E333050303
2 5/16"	IV	10000 lb	A-FRAME	---	---	E443050303



E338050303
 2" • Class III • Cap.: 5,000 lb.
 Apprêt noir / Black primer



D028463
 2 5/16" • Cap.: 12,500 lb



Revêtement en
 poudre noir
 Black powder finish

RA200S0303
 Cap.: 8,000 lb

RA256S0303
 Cap.: 14,000 lb



A256C0317
 2 5/16", 12,000 lb
 Main ajustable (seul)
 Adjustable
 coupler (only)

AC5000300
 12,000 lb.

Support ajustable (seul) à 6 trous
 6 holes adjustable bracket (only)



44305R0317
 2 5/16" • Cap.: 10,000 lb.
 Apprêt / Primer

44305R0500
 2 5/16" • Cap.: 10,000 lb.
 Huileux / Oily

44314R0303
 2 5/16" • Cap.: 14,000 lb.
 Noir / Black



MAINS D'ACCOUPEMENT / COUPLERS



Fini noir
 Black finish
 50°

AW81912
 2 5/16" • 13,000 lb
 Classe/Class 4 • "A" frame



AW80082
 2" • 5000 lb
 2" Timon / Tongue mount



BARRES DE TIRE / DRAW BARS

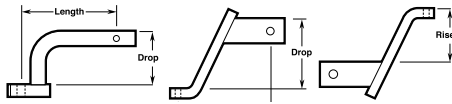

#	Ouverture Opening	Trou de boule Ball hole	Longueur Length	Baisse Drop	Hausse Rise	Capacité Capacity
MXV9001A	2" x 2"	3/4"	7 3/8"	2"	5/8"	3,500 / 300
MXV80212	2" x 2"	1"	9"	3/4"	2"	5,000 / 500
MXV80220	2" x 2"	1"	8"	4"	2 3/4"	5,000 / 500

BARRE DE TIRE AJUSTABLE ADJUSTABLE DRAW BAR



MXV7001

Ouverture Opening	Trou de boule Ball hole	Longueur Length	Baisse Drop	Hausse Rise	Capacité Capacity
2" x 2"	1"	11 3/4"	11"	9 3/4"	6,000 / 600

BARRES DE TIRE À 3 BOULES • 2" X 2" • TRI-BALL DRAW BARS

SLT1500

1 7/8" - 2,000 lb
2" - 6,000 lb
2 5/16" - 10,000 lb



SLT1501

1 7/8" - 2,000 lb
2" - 6,000 lb
2 5/16" - 10,000 lb



MXV1500

1 7/8" - 6,000 lb
2" - 7,500 lb
2 5/16" - 10,000 lb



AJUSTABLE / ADJUSTABLE

MXV9000

1 7/8" - 6,000 lb
2" - 7,500 lb
2 5/16" - 10,000 lb

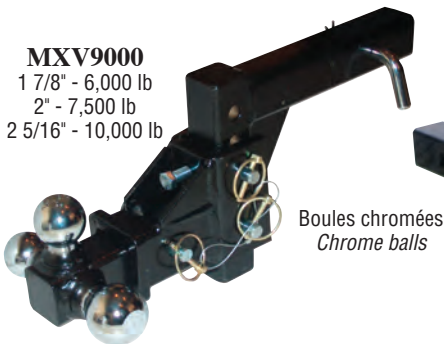

Boules chromées
Chrome balls

Longueur Length	Baisse Drop	Hausse Rise
16"	6"	6"

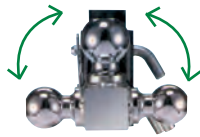

MXV9000R

1 7/8" - 6,000 lb
2" - 7,500 lb
2 5/16" - 10,000 lb

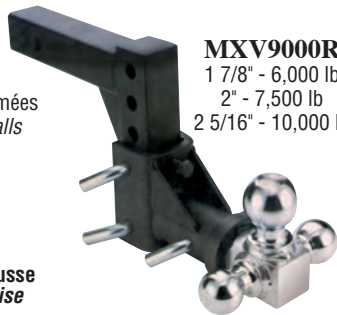

TUBES DE RÉCEPTION RECEIVER TUBES

2" x 2"



MXV52400
6" long

MXV51500
12" long

MXV53600
36" long

1 1/4" x 1 1/4"



MXV9001
6"



ADAPTATEURS DE CONTRÔLE DE BALANCEMENT / SWAY CONTROL ADAPTER BRACKETS



R26003

Barre et boule non comprises. Pour classe III & IV, barre de tire de 2" x 2" & ShadowMount II.
Ball mount and ball not included. For use with Class III & IV, 2" x 2" ball mounts and ShadowMount II



R26005

Barre et boule non comprises. Pour classe II, barre de tire de style 6.
Ball mount and ball not included. For use with Class II, 06 style drawbar.

**ENS. DE DÉPART D'ATTELAGE
TOWING STARTER KITS**



HH80565



HH80563-002

Vendu à la paire
Sold in pairs

#	Classe Class	Ouverture Opening	Boule Ball	Longueur Length	Baisse Drop	Hausse Rise	Capacité lb Capacity lb
HH80565	III	2" x 2"	2"	8 1/2"	2"	3/4"	6,000 / 600
HH80563-002	III	2" x 2"	1 7/8"	8 1/2"	2"	3/4"	6,000 / 600

BARRES DE TIRE / DRAW BARS



#	Trou de boule Ball hole	Longueur Length	Baisse Drop	Hausse Rise	Capacité Capacity
R45322	1 1/4"	10"	3"	1 1/2"	18,000 / 2,000 lbs
R45323	1 1/4"	10"	5"	3 1/2"	18,000 / 2,000 lbs

**BARRES DE TIRE À 3 BOULES
TRI-BALL DRAW BARS**

Capacités / Capacities :
1 7/8" : 2,000 lbs • 2" : 6,000 lbs • 2 5/16" : 10,000 lbs



D80425 Boules noires / Black balls
D80426 Boules chromées / Chrome balls

**EXTENSION POUR RECEVEUR 2" x 2"
RECEIVER EXTENSION**



R11003 14" • 4,000 lb
R11004 18" • 4,000 lb
HH80307 8" • 3,500 lb

**RACCORD RÉDUCTEUR
REDUCER SLEEVE**

TITAN



R58102
Réduit 2 1/2" à 2"
Reduces 2 1/2" to 2"
5.6875" x 2.5" x 2.5"

**EXTENSION POUR ATTELAGE
HITCH BOX EXTENSION**

Pour attelage Série 45 seulement
For 45 series hitch only



TOW BEAST

D45292
Extensions / Extends
24", 34" ou/ or 41" L

**ADAPTATEURS POUR RECEVEUR
RECEIVER ADAPTERS**



Peinturé
Painted



MXV9003 6" 1 1/4" à/to 2"
MXV9004 10" 1 1/4" à/to 2"
MXV9002 7" 2" à/to 1 1/4"

**BARRES DE TIRE AJUSTABLE 2" X 2"
2" X 2" ADJUSTABLE DRAW BARS**



NOIR AVEC GARNITURE EN ACIER INOXYDABLE
BLACK WITH STAINLESS STEEL FACE

TRITRZ12SFP

12" • 10,000 lb
Monture de boule ajustable verrouillable (sécurité contre le vol). S'ajuste facilement vers le haut et le bas (par saut de 1").
Adjustable ball mount key locks to prevent theft (Added security). Easy adjusts up and down in 1" increments.



Boules non comprises
Balls not included



ALUMINIUM / ALUMINUM
6,000 lb
SB2925 Boules / Balls : 1 7/8" & 2"
SB2926 Boules / Balls : 2" & 2 5/16"
Trou de boule / Ball hole 1" Baisse / Drop 6" Hausse / Rise 6"

**ATTELAGE 2" DE TYPE D'ORIGINE
FACTORY STYLE 2" RECEIVER HITCH**



SBJH45
JEEP
Wrangler (JK) 07-13

**ENS. DE CHARNIÈRE REPLIABLE
FOLD AWAY HINGE KITS**



HDPB330301 3,500 lbs 3" x 3" timon/tongue
HDPB340101 7,500 lbs 3" x 4" timon/tongue
HDPW330300 7,500 lbs 3" x 3" timon/tongue

À BOULONNER
BOLT-ON

À SOUDER
WELD-ON

ACTIVATEURS DE FREINS PAR PRESSION / SURGE BRAKE ACTUATORS

Peut être soudé ou boulonné sur support de 3" / 3" tongue weld-on or bolt-on application



AW83005
2" • 8,000 lb

Timon / Tongue weight: 1,000 lb max
Noir / Black



AW84132
2" • 6,000 lb

Timon / Tongue weight: 900 lb max
Plaqué au zinc / Zinc plated

ACCESSOIRES / ACCESSORIES

6,000 & 8,000 lb



AW85841

Maître cylindre/activateur
Master cylinder/surge brake



AW87478

Bouchon d'huile
Oil cover

POIGNÉE DE COUPLEUR COUPLER HANDLE



CH-0701
Vendu en boîte
Sold in a box



Fait sur tous les coupleurs de
1 7/8" & 2"
Fits all 1 7/8" & 2" couplers



BARRES DE TIRE / BALL MOUNTS



	Ouverture Openings	Trou de boule Ball hole	Longueur Length	Baisse Drop	Capacité Capacity
1803005	2"	1 1/4"	8"	2"	6,000/600 lb
1803007	2"	1 1/4"	10"	2"	6,000/600 lb
1803010	2"	1 1/4"	8"	4"	6,000/600 lb
1803013	2"	1 1/4"	10"	4"	6,000/600 lb
1803015	2"	1 1/4"	10"	6"	6,000/600 lb
1803017	2"	1 1/4"	10"	8"	6,000/600 lb
1803059	2"	1 1/4"	9.4"	6"	17,000/1,700 lb
1803056	2"	1 1/4"	7.9"	4"	20,000/2,000 lb
1803051	2"	1 1/4"	7.6"	2"	20,000/2,000 lb

TUBES DE RÉCEPTION • 2" x 2" • RECEIVER TUBES



RT25818
18"

RT25824
24"

PEINTURÉ NOIR / PAINTED BLACK

RT25806B
6"

RT25818B
18" l

RT25824B
24"

BARRE DE TIRE À 2 BOULES DOUBLE BALL DRAW BAR

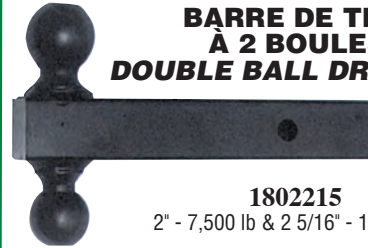

1802215
2" - 7,500 lb & 2 5/16" - 10,000 lb

BARRE DE TIRE À 3 BOULES TRI-BALL DRAW BAR

2" x 2"



MXV1500

1 7/8" - 6,000 lb,
2" - 7,500 lb & 2 5/16" - 10,000 lb

CONVERT-A-BALL™

BARRES DE TIRE À COUSSINS DE POLYPROPYLÈNE POLYPROPYLENE CUSHIONED SHANK DRAW BAR

CBAMSC2



VUE DÉCOUPÉE
CUT AWAY VIEW



POLYPROPYLENE

ACIER / STEEL

Abaissement de 2". La barre de tire à coussins réduit les coups associés aux démarrages et aux arrêts lorsqu'on traîne une remorque. Compatible avec tous les attelages de type receveur 2" x 2". Nécessite une cheville de 5/8" (non comprise).

2" drop. The cushioned hitch bar will reduce the slams and bangs associated with trailer towing during starting and stopping. It is compatible with all 2" x 2" receiver hitches. Requires a 5/8" hitch pin (not included).

BARRES DE TIRE / DRAW BARS

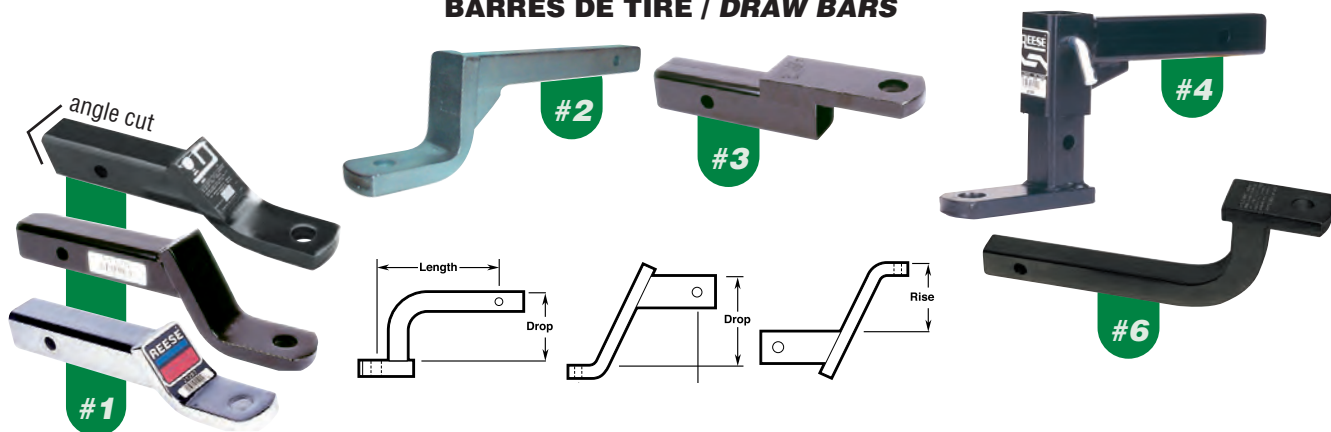

#	Type Style	Ouverture Opening	Trou de boule Ball hole	Longueur Length	Baisse Drop	Hausse Rise	Capacité lb Capacity lb
D3593*	1	1 1/4" x 1 1/4"	3/4"	6 5/8"	2 3/4"	2 1/8"	2,000 / 200
D36071*	1	1 1/4" x 1 1/4"	3/4"	7 3/16"	3 1/4"	2 5/8"	3,500 / 300
D3592*	1	1 1/4" x 1 1/4"	3/4"	9 3/4"	2 3/4"	2 1/8"	2,000 / 200
D3594*	6	1 1/4" x 1 1/4"	3/4"	10"	—	4"	2,000 / 200
D3590*	3	1 1/4" x 1 1/4"	3/4"	6 5/8"	—	5/8"	2,000 / 200
D36051*	3	1 1/4" x 1 1/4"	3/4"	7"	1 1/4"	5/8"	3,500 / 300
D36053*	3	1 1/4" x 1 1/4"	3/4"	9"	1 1/4"	5/8"	3,500 / 300
D3591*	3	1 1/4" x 1 1/4"	3/4"	9 3/4"	—	5/8"	2,000 / 200
D36061*	6	1 1/4" x 1 1/4"	3/4"	9 3/4"	—	3 1/8"	3,500 / 300
D36065*	6	1 1/4" x 1 1/4"	3/4"	10"	—	5"	3,500 / 300
D36063*	6	1 1/4" x 1 1/4"	3/4"	11 3/4"	—	3 1/8"	3,500 / 300
D36078*	2	1 1/4" x 1 1/4"	3/4"	7 3/8"	4 3/4"	—	3,500 / 300
HH80137	1	2" x 2"	1 1/4"	9"	6"	---	10,000 / 1,000
MXV80221	1 angle cut	2" x 2"	1"	8 1/2"	2"	3/4"	6,000 / 600
D40346	1 angle cut	2" x 2"	1"	8 1/2"	6"	4 3/4"	6,000 / 600
HH80227	1 angle cut	2" x 2"	1"	8 1/2"	3/4"	2"	6,000 / 600
D40344	1 angle cut	2" x 2"	1"	9"	4"	2 3/4"	7,500 / 750
HH80228	1 angle cut	2" x 2"	1"	11 1/4"	4"	2 3/4"	6,000 / 600
HH80232	1 angle cut	2" x 2"	1"	16"	2"	3/4"	6,000 / 600
HH80233	1 angle cut	2" x 2"	1"	16"	4"	2 3/4"	6,000 / 600
HH80239	1	2" x 2"	1"	9"	4"	2 3/4"	7,500 / 750
D2923*	1 angle cut	2" x 2"	1"	8 1/2"	2"	3/4"	7,500 / 750
R21342	1 angle cut	2" x 2"	1"	8 1/2"	2"	3/4"	7,500 / 750
R21341	3	2" x 2"	1"	12"	2"	3/4"	5,000 / 500
R21343	1	2" x 2"	1"	10 1/2"	2"	3/4"	6,000 / 600
R21345	1 angle cut	2" x 2"	1"	11"	4"	2 3/4"	6,000 / 600
D2736	3	2" x 2"	1"	12"	2"	3/4"	6,000 / 600
R21347	2	2" x 2"	1"	10"	8"	6 3/4"	5,000 / 500
R21141	4	2" x 2"	1"	13 1/2"	7 1/2"	6 1/4"	5,000 / 500
HH80123	1 zinc	2" x 2"	1 1/4"	8 1/2"	4"	3"	12,000 / 1,200
HH80125	1 zinc	2" x 2"	1 1/4"	9 1/2"	8"	7"	12,000 / 1,200
D4281	1 zinc	2" x 2"	1 1/4"	8 1/2"	4"	3"	12,000 / 1,200
D4282	1 zinc	2" x 2"	1 1/4"	9 1/2"	6"	5"	12,000 / 1,200
R21330	1 1-piece	2" x 2"	1 1/4"	8 1/2"	2"	1"	16,000 / 2,400
D40331	1 1-piece	2" x 2"	1 1/4"	9 1/4"	4"	3"	16,000 / 1,600
D4280	3 zinc	2" x 2"	1 1/4"	8 1/2"	2"	1"	12,000 / 1,200
D6580*	5	2" x 2"	1"	12"	7 3/8"	6 1/8"	6,000 / 600
R45122	1	2 1/2" x 2 1/2"	1 1/4"	9 3/4"	3"	1 1/2"	14,000 / 1400

* Cheville et goupille incluses / Pin & clip included



BARRES DE TIRE / DRAW BARS

BARRE DE TIRE EN ALUMINIUM BILLETTE POLI. ANTICLIQUETIS. POLISHED BILLET ALUMINUM BALL MOUNT. ANTI-RATTLE TENSIONED.

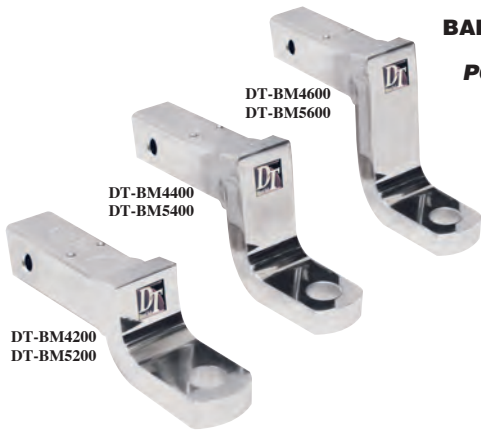
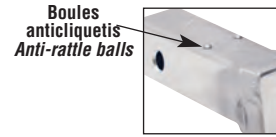

#	Ouverture Opening	Trou de boule Ball hole	Longueur Length	Baisse Drop	Hausse Rise	Capacité Capacity
DT-BM4200	2" x 2"	1"	11 1/2"	2"	1"	14,000 / 2,000
DT-BM4400	2" x 2"	1"	12"	4"	3"	14,000 / 2,000
DT-BM4600	2" x 2"	1"	12 1/2"	6"	5"	14,000 / 2,000
DT-BM5200	2" x 2"	1 1/4"	11 1/2"	2"	1"	14,000 / 2,000
DT-BM5400	2" x 2"	1 1/4"	12"	4"	3"	14,000 / 2,000
DT-BM5600	2" x 2"	1 1/4"	12 1/2"	6"	5"	14,000 / 2,000

BARRE DE TIRE EN ALUMINIUM BILLETTE POLI. ANTICLIQUETIS. VERROUILLAGE AUTOMATIQUE. POLISHED BILLET ALUMINUM BALL MOUNT. ANTI-RATTLE TENSIONED. SELF-LOCKING.

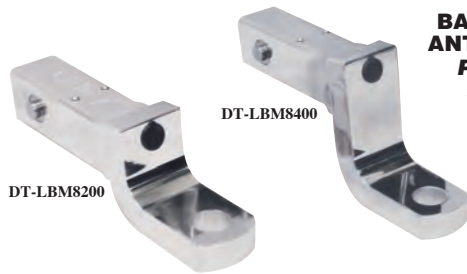
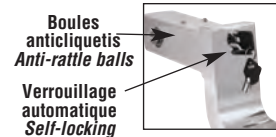

#	Ouverture Opening	Trou de boule Ball hole	Longueur Length	Baisse Drop	Hausse Rise	Capacité Capacity
DT-LBM8200	2" x 2"	1"	11 1/2"	2"	1"	14,000 / 2,000
DT-LBM8400	2" x 2"	1"	12"	4"	3"	14,000 / 2,000

BARRE AJUSTABLE DOUBLE AVEC SYSTÈME DE VERROUILLAGE DOUBLE ADJUSTABLE DUAL LOCKING DOUBLE BALL DRAW BAR



#	Ouverture Opening	Grosueur des boules Ball size	Longueur Length	Baisse Drop	Hausse Rise	Capacité Capacity
DT-ALBM6400	2" x 2"	2" & 2 5/16"	12"	4"	5"	10,000 / 1,500
DT-ALBM6600	2" x 2"	2" & 2 5/16"	12"	6"	7"	10,000 / 1,500
DT-ALBM6800	2" x 2"	2" & 2 5/16"	12"	8"	9"	10,000 / 1,500
DT-ALBM7000	2" x 2"	2" & 2 5/16"	12"	10"	11"	10,000 / 1,500

BARRE DE TIRE DOUBLE "SOLID TOW" AJUSTABLE EN ALUMINIUM SOLID TOW ADJUSTABLE ALUMINUM DOUBLE BALL HITCH



#	Ouverture Opening	Grosueur de boule Ball size	Longueur Length	Baisse Drop	Hausse Rise	Capacité Capacity
DT-STBM6400	2" x 2"	2" & 2 5/16"	12"	4"	5"	10,000 / 1,500
DT-STBM6407	2" x 2"	1 7/8" & 2"	12"	4"	5"	10,000 / 1,500
DT-STBM6600	2" x 2"	2" & 2 5/16"	12"	6"	7"	10,000 / 1,500
DT-STBM6800	2" x 2"	2" & 2 5/16"	12"	8"	9"	10,000 / 1,500
DT-STBM7000	2" x 2"	2" & 2 5/16"	12"	10"	11"	10,000 / 1,500

BARRE AJUSTABLE DOUBLE AVEC SYSTÈME DE VERROUILLAGE DOUBLE ADJUSTABLE DUAL LOCKING DOUBLE BALL HITCH

Tige ajustable 2.5" / 2.5" adjustable shank



#	Ouverture Opening	Grosueur des boules Ball size	Longueur Length	Baisse Drop	Hausse Rise	Capacité Capacity
DT-ALBM6625	2 1/2" x 2 1/2"	2" & 2 5/16"	12"	6"	7"	10,000 / 1,500



BOULES DE REMORQUAGE / HITCH BALLS



BOULE BALL	DIA. TIGE SHANK DIA.	LONGUEUR TIGE SHANK LENGTH	CAPACITÉ CAPACITY	CHROME CHROME	ZINC ZINC
1 7/8"	3/4"	1 1/2"	2,000 lb	D63810	D63811
1 7/8"	3/4"	2 3/8"	2,000 lb	D63812	D63813
1 7/8"	3/4"	3 3/8"	2,000 lb	D63814	--
1 7/8"	1"	2 1/8"	2,000 lb	D63816	D63817
1 7/8"	1"	3 3/8"	2,000 lb	D63818	--
2"	3/4"	1 1/2"	3,500 lb	D63887	D63821
2"	3/4"	1 1/2"	3,500 lb	--	D63820
2"	3/4"	2 3/8"	3,500 lb	D63822	D63823
2"	3/4"	3 3/8"	3,500 lb	D63824	--
2"	1 1/4"	2 3/4"	8,000 lb	D63830	--
2"	1"	2 1/8"	6,000 lb	D63826	D63827
2"	1"	3 3/8"	6,000 lb	D63828	--
2 5/16"	1"	2 1/8"	6,000 lb	D63832	D63833
2 5/16"	1 1/4"	2 3/4"	12,000 lb	D63834	D63835
2 5/16"	1 1/4"	2 3/4"	14,000 lb	D63836	--
2 5/16"	1 1/4"	2 3/4"	20,000 lb	D63840	--

EMBALLÉ / PACKAGED



D63887
CHROME • 3,500 lb
 Boule/Ball: 2"
 Dia. tige/Shank dia.: 3/4"
 Longueur tige: 1 1/2"
 Shank length: 1 1/2"

D63899
CHROME • 8,000 lb
 Boule/Ball: 2"
 Dia. tige/Shank dia.: 1 1/4"
 Longueur tige: 2 3/4"
 Shank length: 2 3/4"

SYSTÈMES DE BOULES DE REMORQUAGE INTERCHANGEABLE HITCH BALL SYSTEMS



D63801
 5,000 lb.
 Boules: 1 7/8", 2"
 Dia. tige: 3/4"
 Balls: 1 7/8" & 2"
 Shank dia.: 3/4"

D63802
 8,000 lb.
 Boules: 1 7/8", 2"
 Dia. tige: 1"
 Balls: 1 7/8" & 2"
 Shank dia.: 1"

D63803
 8,000 lb.
 Boules: 1 7/8", 2", 2 5/16"
 Dia. tige: 1"
 Balls: 1 7/8", 2", 2 5/16"
 Shank dia.: 1"

BAGUE DE RÉDUCTION POUR BOULE HITCH BALL BUSHING



HH80106
 1 1/4" à/to 1"

PROTECTEUR DE PARE-CHOC DIAMOND PLATE BUMPER GUARD



HH80470
 Trou 1" / 1" hole

COUVRE-BOULE BALL COVER



HH42250
 Noir/Black
 1 7/8" & 2"



LUBRIFIANT POUR BOULE BALL LUBE

R58117
 4 oz.

CONVERT-A-BALL™

SYSTÈMES DE BOULES DE REMORQUAGE / HITCH BALL SYSTEMS



CB-944-800
 Tige 3/4" Shank
 3,500 lb.
 Boules / Balls : 1 7/8" & 2"

CB-944-901
 Tige 1" Shank
 8,000 lb.
 Boules / Balls : 1 7/8" & 2"



CB-944-300
 Boule / Ball: 1 7/8"

CB-944-600
 Boule / Ball: 2 5/16"

CB-944-400
 Boule / Ball: 2"



CB-944-102
 Tige 1" Shank
 8,000 lb.



BOULES DE REMORQUAGE CHROMÉES / CHROME HITCH BALLS



Filet intérieur
Internal thread

BOULE BALL	DIA. TIGE SHANK DIA.	LONGUEUR TIGE SHANK LENGTH	CAPACITÉ CAPACITY	
1 7/8"	3/4"	1 3/4" int.	2,000 lb	22-0100
1 7/8"	3/4"	1 3/4" int.	2,000 lb	V176
1 7/8"	3/4"	2"	2,000 lb	V17650
1 7/8"	3/4"	2 1/2"	2,000 lb	22-0125
1 7/8"	1"	2"	2,000 lb	V171050
1 7/8"	1"	2 1/8"	3,500 lb	22-0106
2"	3/4"	1 3/4" int.	3,500 lb	22-0102
2"	3/4"	1 3/4" int.	3,500 lb	V206
2"	3/4"	2"	3,500 lb	V20650
2"	3/4"	3"	3,500 lb	22-0130
2"	1"	2"	5,000 lb	V201050
2"	1"	2 1/8"	5,000 lb	22-0111
2"	1 1/8"	2 1/4"	7,000 lb	RB2000
2 5/16"	1"	2 1/8"	5,000 lb	22-0115
2 5/16"	1"	2 1/8"	6,000 lb	V25161050
2 5/16"	1 1/8"	2 3/8"	12,000 lb	RB2516
2 5/16"	1 1/4"	2 3/4"	30,000 lb	1802050 NOIR / BLACK

BAGUE DE RÉDUCTION POUR BOULE HITCH BALL BUSHING



MXV531
1" à 3/4"



RAMPE DE TRACTION / TRACTION RAMP



SB2790

- Fabriqué de plastique renforcé de nylon
- Chaque rampe supporter 7,700 lb
- Vendu à la paire avec un sac de rangement en nylon
- Idéal pour la boue, la neige, le sable et autre surface instable
- Conception empilable
- *Manufactured of Nylon Reinforced Plastic*
- *Each ramp can support up to 7,700 lb*
- *Sold in pairs & comes with a nylon storage bag*
- *Perfect for mud, snow, sand or any loose terrain you find yourself in*
- *Stackable design*

PELLE REPLIABLE / FOLDABLE SHOVEL



SB2728

- Sac de rangement inclus
- Rebord dentelé pour les conditions les plus difficiles
- Collet à 2 positions pour pelleter ou piocher
- Collet et poignée en polycarbonate
- *Soft side storage bag included*
- *Serrated edge to handle the roughest conditions*
- *Double position neck allows for picking or shoveling*
- *Polycarbonate handle & neck*

HACHE / AXE

SB2828

- Lame en inox 402 traité à la chaleur
- Tête de hache de 4" x 7.5"
- Poignée ergonomique renforcé de nylon
- 3 outils en 1
- Fente pour serrer/désserrer anneau en "D"
- Ouverture hex 19mm pour noix et boulons
- Ensemble de survie et boussole dans la poignée
- Comprend un étui de protection

- *402 Stainless Heat treated blade*
- *4" x 7.5" Axe Head*
- *Nylon reinforced ergonomic handle*
- *3 tools in one*
- *D-ring slot to tighten and loosen D-ring pin*
- *19mm hex to aid in loosening bolts/nuts*
- *Survival Kit and compass in handle*
- *Includes protective sheath*



OUTIL 10-EN-1 10 IN 1 TOOL



SB2829

- Pince à ressort
- Poignée confort en aluminium
- Lame en acier traité à la chaleur 3CR13
- Avec étui en nylon ballistique
- *Spring loaded plier jaws*
- *Aluminum comfort grip*
- *3CR13 heat treated steel blade*
- *Ballistic Nylon carrying case included*

Les codes en ROUGE indiquent un item discontinué à quantité limitée / Codes in RED indicate a limited quantity discontinued item

COUVERTS D'OUVERTURE D'ATTELAGE / RECEIVER COVERS



**ACIER CHROMÉ
CHROMED STEEL**

D5351
1 1/4" x 1 1/4"

D5352
2" x 2"



**PLASTIQUE CHROMÉ
CHROMED PLASTIC**

D1944
2" x 2"

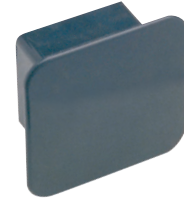

**PLASTIQUE NOIR
BLACK PLASTIC**

D2211
1 1/4" x 1 1/4"

D5363
2" x 2"

REESE®

HIDDEN HITCH®

COUVERTS D'OUVERTURE D'ATTELAGE RECEIVER COVERS



R74099
2" x 2"
NYLON



R74547
2" x 2"
Plastique noir
Black plastic



R58070
1 1/4" x 1 1/4"
NYLON

COUVERT D'OUVERTURE D'ATTELAGE RECEIVER COVER



HH60037
1 1/4" x 1 1/4"
CAOUTCHOUC / RUBBER

PROTECTEUR UNIVERSEL POUR BOULE D'ATTELAGE UNIVERSAL TRAILER BALL COVER



HH42251
Pour boule 2 5/16"
Fits 2 5/16" ball

PlastiColor®

COUVERTS D'OUVERTURE D'ATTELAGE EN ALUMINIUM BROSSÉ POUR OUVERTURES DE 1 1/4" ET 2" BRUSHED ALUMINUM RECEIVER COVERS FOR 1 1/4" AND 2" OPENINGS



PL2258R01
4 1/2" X 2 1/2"



PL2226



PL2237



PL2238

AG

Au-TOMOTIVE GOLD, INC.
The Driver's Choice

ECLA®

PERFORMANCE RACING TEAM

COUVERTS D'OUVERTURE D'ATTELAGE AVEC LOGO CHROMÉ HITCH PLUGS WITH CHROME LOGO POUR OUVERTURES DE 2" / FOR 2" OPENINGS



TCAD2C
CADILLAC



TCHVBC
CHEVROLET



TGMC2C
GMC

COUVERTS D'OUVERTURE D'ATTELAGE RECEIVER COVERS POUR OUVERTURE 1 1/4" & 2" FOR 1 1/4" & 2" OPENINGS



PA24-508
Yeux à DEL rouge
LED red eyes



PA24-507
18 DEL/LED



TRAMOEMCC
RAM



TTOYC
TOYOTA

PILOT™

COUVERTS D'OUVERTURE D'ATTELAGE POUR OUVERTURE 2" / RECEIVER COVERS FOR 2" OPENING

Deux épaisseur d'acier inoxydable / Dual layer stainless steel



PCR-B-15



PCR-B-06A



PCR-B-17

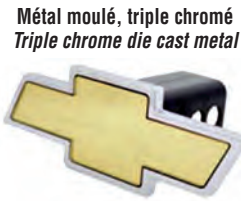

Métal moulé, triple chromé
Triple chrome die cast metal

PCR-132



Aluminium / Aluminum

PRBP-112

POUR OUVERTURES 1 1/4" ET 2" / FOR 1 1/4" AND 2" OPENINGS



PCR-402



PCR-414



PCR-018
LES YEUX S'ILLUMINENT
EYES LIGHT UP



PCR-402L
Avec feux d'arrêt à DEL
With brake LED light



PCR-311



PCR-004A

COUVERTS D'OUVERTURE D'ATTELAGE AVEC FEU D'ARRÊT POUR OUVERTURES 2" RECEIVER COVERS WITH BRAKE LIGHT FOR 2" OPENINGS



PCR-017C



PCR-017D



PCR-017F



PCR-017G



PCR-014



PCR-007C



PCR-007D



PCR-007F



PCR-007G



PCR-005
Sans feu d'arrêt
Without brake light

GOUPILLE DE SÉCURITÉ / CINCH BONE

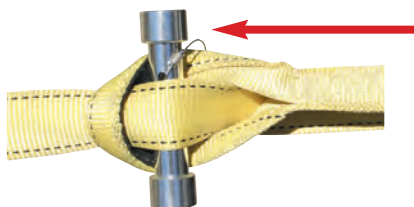

Aluminium "Billet"
Billet aluminum

PBC-902
Sécurise la courroie
sans faire de nœud
Secures strap without
tying knot

COURROIE DE REMORQUAGE / TOW STRAP

HIGHLAND™
The Pro's Brand!



HG1017800
2" x 20' • 5667 lbs
Résistance avant rupture : 17,000 lbs
Break strength: 17,000 lbs



CADENAS / PADLOCKS

- 2" & 2" x 9/32" plaqué chrome. Manille en acier ultra résistant
- Serrure en acier inoxydable de calibre automobile, l'obturateur de verrouillage empêche la saleté et la corrosion
- Gaine en caoutchouc robuste qui protège votre équipement contre les intempéries
- 2" body & 2" x 9/32" chrome plated, hardened steel shackle for heavy duty applications
- Automotive grade stainless steel lock shutter keeps out dirt, prevents corrosion
- Rugged rubber jacket keeps out weather, protects your gear

EMBALLAGE-COQUES BLISTER PACKS **N**

BOL7018517	GM-1 (Ancien model / Early models)
BOL7018518	GM-2 (Model récent / Late models)
BOL7018519	Ford
BOL7018520	Dodge / Jeep / Ram
BOL7023539	Toyota 00-13

DODGE / JEEP / RAM

05-10	Commander
07-13	Compass
90-11	Dakota
98-12	Durango
92-13	Grand Cherokee
02-13	Liberty
07-13	Patriot
90-13	Ram
90-05	Ram Van
91-13	Wrangler

FORD

96-13	Econoline Van/Chassis
00-06	Excursion
97-13	Expedition
96-13	Explorer
96-13	F150/250/350
1999	F Super Duty
96-11	Ranger

BARRURES POUR RECEVEUR / RECEIVER LOCKS



- Tige en acier inoxydable de 5/8" de diamètre s'adapte aux récepteurs de classe 3 et 4
- Serrure de calibre automobile, l'obturateur de verrouillage empêche la saleté et la corrosion
- Gaine en caoutchouc robuste qui protège votre équipement contre les intempéries
- 5/8" diameter stainless steel shaft fits class 3 & class 4 receivers
- Automotive grade lock shutter keeps out dirt, prevents corrosion
- Rugged rubber jacket & cap keeps out weather, protects your gear

EMBALLAGE-COQUES BLISTER PACKS **N**

BOL7018445	GM-1 (Ancien model / Early models)
BOL7018446	GM-2 (Model récent / Late models)
BOL7018447	Ford
BOL7018448	Dodge / Jeep / Ram
BOL7023584	Toyota 00-13



GM-1 CHEVY / GMC

95-98	C/K Pick-up
96-07	Express Van
95-05	Jimmy
03-05	Kodiak
95-05	S10 Blazer & Pickup
95-05	Safari
99-07	Savana Van
99-06	Silverado / Sierra
95-05	Sonoma
95-06	Suburban
95-06	Tahoe
02-09	Trailblazer
05-05	Top Kick
95-06	Yukon

CÂBLES DE VERROUILLAGE / CABLE LOCKS



- 6' d'auto-enroulement, 5/16" de revêtement en vinyle, câble en acier tressé
- Serrure de calibre automobile, l'obturateur de verrouillage empêche la saleté et la corrosion
- Gaine en caoutchouc robuste qui protège votre équipement contre les intempéries
- 6' self-coiling 5/16" vinyl coated, braided steel cable
- Automotive grade lock shutter keeps out dirt, prevents corrosion
- Rugged rubber jacket & cap keeps out weather, protects your gear

EN VRAC / BULK

BOL7018444	Dodge
BOL7018441	GM-1

GM-2 CHEVY / GMC

07-13	Avalanche
08-13	Express Van
08-13	Savana Van
07-13	Silverado / Sierra
06-13	Suburban
06-13	Tahoe
09-13	Traverse
06-13	Yukon

POIGNÉE DE HAYON TAILGATE HANDLE



BOL5922987
Fait sur les Chevrolet 07-13 et camions GMC
Fit 2007 to present Chevy & GMC trucks



BARRURE POUR ROUE DE SECOURS (JEEP) JEEP SPARE TIRE LOCK

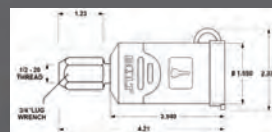

BOL5922986
Jeep Wrangler 91-12



DODGE:
SERRURES FAIT SUR LES VÉHICULES DODGE
LOCK FITS THESE DODGE VEHICLES

FORD:
SERRURES FAIT SUR LES VÉHICULES FORD
LOCK FITS THESE FORD VEHICLES

GM-1: SERRURES FAIT SUR LES ANCIENS VÉHICULES GM
LOCK FITS OLDER GM VEHICLES

GM-2: SERRURES FAIT SUR LES NOUVEAUX VÉHICULES GM
LOCK FITS NEWER GM VEHICLES

**BARRURES POUR REMORQUE
TRAILER LOCKS**



ST-10
Barrure pour
5^e roue
5" wheel lock



ST-30
Barrure pour
Gooseneck
Gooseneck lock

**BARRURE DE COUPLEUR
UNIVERSELLE
UNIVERSAL COMBO LOCK**



63226
Barrure de coupleur
universelle
Universal coupler lock

63226KA-3
Même clé / Keyed alike
Paquet de 3 / Pack of 3

**BARRURES DE COUPLEUR
COUPLER LOCKS**



"GORILLA GUARD"
D63227
Pour coupleurs
de 2 5/16"
For 2 5/16"
couplers

D63228
Pour coupleurs
de 2"
For 2" couplers

**PLAQUE POUR BARRURE DE 5^E ROUE
PIN LOCK PLATE FOR 5TH WHEEL**

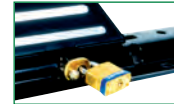

D58093

Paquet de 4, barrure non incluse / Pack of 4, lock not included

BARRURES POUR RECEVEUR / RECEIVER LOCKS



D63253
Cheville courbée de 5/8" dia.
pour receveur de 2 1/2"
Bent pin 5/8" for 2 1/2" receiver

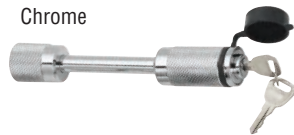

D63252
5/8" dia.
Pour/For: 2 1/2" Receveur/Receiver



D63234
Manche en acier inoxydable/Stainless steel sleeve
Pour receveurs/For receivers: 1 1/4", 2, 2 1/2"



D63251
Goupille verrouillable / King Pin Lock
Jaune & Chrome / Yellow & Chrome

ENSEMBLE DE BARRURES / COMBO LOCK SET



- Coupleur / Coupler
- Attelage / Hitch:

D63250
GOUPILE DE SÉCURITÉ / DOGBONE LOCK
Fini - Chrome - Finish
Combinaison d'épingles de coupleur 1/2" - 5/8"
1/2" - 5/8" • Hitch pin coupler combo

**BARRURE 1/2" POUR 5^E ROUE
1/2" LOCK FOR 5TH WHEEL**



D63254
Barrure 1/2" pour 5^e roue / 1/2" lock for 5th wheel

CHEVILLES VERROUILLABLE / LOCKING PINS



D63224
1/2" dia - pour receveurs de 1 1/4" et
"Fifth Wheel" avec barre de base
1/2" dia. - for 1 1/4" receivers & Fifth Wheel base rails

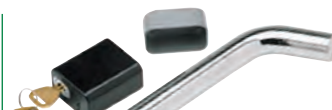

HH63223
Cheville coude de 5/8
pour receveur de 2 et 2 1/2"
Bent Pin 5/8" for 2" & 2 1/2" receivers

**BARRURES DE COUPLEUR
COUPLER LOCKS**

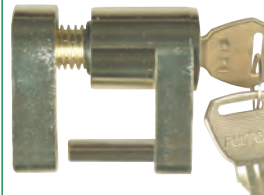

D63225
5 3/4"L x 1 1/4"W x 7"H



**BARRURE DE COUPLEUR
COUPLER LOCK**



OR20-015
1/2" dia. • 2 1/8" L - Class I & II



**GOUPILES À SERRURE
RECEIVER LOCKS**

Vendu à l'unité / Sold per unit



PCR-094
5/8" pour receveur 2" x 2" / 5/8" for 2" x 2" Receiver





BARRURE DE REMORQUE MAXIMUM SECURITY TRAILER LOCK



DT-25013
Incl. 4 clés / Incl. 4 keys
Fait sur coupleur / Fits coupler :
1 7/8" à 2 5/16"

CADENAS D'ACCOUPEMENT / RECEIVER LOCKS



DT-30005 2" & 2"
Pour cheville verrouillable 5/8". Fait sur receveur
Classe III, IV & V. Acier forgé en plaqué chrome.
For 5/8" locking hitch pin fits all Class III, IV & V receivers.
Chrome plated forged steel



DT-31005 2 1/2" & 2 1/2"
Pour cheville verrouillable 5/8". Fait pour barre 2 1/2" x 2 1/2"
(Classe V). Acier forgé en plaqué chrome.
For 5/8" locking hitch pin. Long span for 2.5" Class V. Chrome
plated forged steel



CADENAS D'ACCOUPEMENT ET BARRURE DE COUPLEUR TRAILER RECEIVER AND COUPLER LOCK COMBO PACK

DT-35010
1 1/4" ou/ou 2"
ou les deux /or the two of them



BARRURE DE COUPLEUR TRAILER COUPLER LOCK

DT-30010



SERRURES POUR ATTELAGE - LIFELONG 5/8" dia. - HITCH LOCKS



580400
Manche courbé
pour Classes III & IV
Bent Shank lock
for Class III & IV

2" & 2"



580401
Goupille pour
Classes III & IV
Dogbone lock
for Class III & IV

2" & 2"



580402
Goupille en acier inoxydable
pour Classes III & IV
Stainless Steel Dogbone
lock for Class III & IV

2" & 2"

SERRURE POUR REMORQUE - LIFELONG - TRAILER LOCK



580403
Barrure de
coupleur
Coupler lock

SERRURES POUR ATTELAGE - BULLDOG 5/8" & 1/2" dia. - HITCH LOCKS



580405
Goupille avec manche pour
receveurs carrés de 1 1/4" & 2"
Dogbone lock w/sleeve for
1 1/4" & 2" square receivers



580406
Combinaison de serrures en acier inoxydable,
goupille de 5/8" avec manche pour receveurs
carrés et coupleur de 1 1/4" & 2"
Stainless steel combo lock set, 5/8" dogbone with
sleeve for 1 1/4" & 2" square receivers and coupler



580407
Barrure facile d'accès pour
receveurs carrés de 1 1/4" & 2"
Easy access lock w/sleeve
for 1 1/4" & 2" square
receivers

COMBINAISON DE SERRURES - LIFELONG - COMBO LOCK



580404
Combinaison de serrures : goupille et
coupleur pour Classes III & IV
Combo lock set, Dogbone
receiver/coupler for Class III & IV

2" & 2"

SERRURES POUR REMORQUE - BULLDOG - TRAILER LOCKS



580408
Serrure en acier
inoxydable
pour coupleur
Stainless steel
coupler lock



580409
Serrure facile
d'accès pour
coupleur long
Easy access long
coupler lock



580410
Serrure ajustable
pour coupleur
Adjustable
coupler lock

CADENAS D'ATTELAGE LOCKING HITCH PINS



S64027
Cadenas d'attelage 2"
pour Class III - 5/8"
5/8" Class III locking
hitch pin 2"



S64029
Cadenas d'attelage
1 1/4" pour
Class II - 1/2"
1/2" Class II locking
hitch pin 1 1/4"

CADENAS D'ATTELAGE / RECEIVER LOCKS

1 1/4" & 2"



1479DAT
À poussoir / Push to lock
Tête articulé / Swivel Head

1 1/4" & 2"



2848DAT
Cheville courbée & loquet du coupleur ajustable
Bent pin receiver and adjustable coupler latch lock

1 1/4" & 2"



2866DAT
5/8" & 1/2"
Tête articulé / Swivel Head

1 1/4"



1472DAT
1/2" Altère
1/2" Barbell



1469DAT
Cadenas d'accouplement 5/8". 3 1/8" (large) en acier inox. Faits sur les anciens models de camion : Ford F350, Toyota tundra, GM Silverado/Sierra, camion équipé avec un ensemble de remorquage HD.
5/8" receiver lock. 3 1/8" wide stainless steel. Fits late model trucks, including : Ford F350, Toyota tundra, GM Silverado/Sierra, trucks equipped with HD towing packages.



1470DAT
Pour trous de 5/8" & 1/2". Tourne 360° pour un accès facile. Câble d'acier en tresse 3/8". 8' de câble.
Fits 1/2" & 5/8" receiver lock. Rotates 360° for easy access. 3/8" braided steel cable. 8' cable.

CÂBLES À CADENAS / CABLE LOCKS



614DAT
6' x 1/4"



8142DAT
6' x 7/16"

CÂBLE DE SÉCURITÉ 40" 40" SAFETY CABLE



2829DATSC
Vendu à la paire
Sold in pairs

CHAÎNE (3') AVEC CADENAS INTÉGRÉ (3') CHAIN WITH INTEGRATED LOCK



8291DPS

VERROU DE VOLANT STEERING WHEEL LOCK



252BLCDAT

CADENAS POUR DISQUE 2" 2" DISC BRAKE LOCK

Avec cordon de rappel
With reminder cord



8303DPS

BARRURE POUR PNEU DE RECHANGE SPARE TIRE LOCK



262DAT

ENS. DE 4 CADENAS SET OF 4 PADLOCKS



3008DAT
1 9/16"
Fonctionne avec la même clé
Keyed alike

ARMOIRE À CLÉS AVEC SERRURE LOCKING KEY CABINET



7131D
Construction en acier robuste
Heavy duty steel construction
7 3/4"H x 6 1/4"W x 3"D

BARRURE DE PIVOT D'ACCOUPEMENT POUR 5^{ÈME} ROUE 5TH WHEEL PIN LOCK



ML387
Incl.: cadenas No.5 intégré avec 2 clés.
Incl.: integrated No.5 lock with 2 keys.

CADENAS UNIVERSEL POUR MAIN & 5^{ÈME} ROUE UNIVERSAL 5TH WHEEL & GOOSENECK LOCK



2989AT

BARRURE RAIL D'ARRIMAGE / TRACK LOCK



8251DAT
Fait sur Dodge, Ford, GM, Toyota & rail d'arrimage. Fait aussi sur E-Track et TracRac. Support, barrure et quincaillerie en acier inoxydable.
Fits Dodge, Ford, GM, Toyota & cargo rails. Also fits E-track and TracRac. Stainless steel bracket, lock and hardware.



BARRURE POUR ÉCHELLE LADDER LOCK



8252DAT
Se monte sur le porte-échelle pour barrer l'échelle ou votre cargo. Inclus adaptateurs pour 1.5" rond, 1.5" & 1.75" carré et 1" & 2" rectangle. Collet, barrure et quincaillerie en acier inoxydable.
Locking point that mounts on ladder rack to lock ladder or cargo. Comes with adapters for 1.5" round, 1.5" & 1.75" square, and 1" x up to 2" rectangle ladder racks. SS collar, lock and hardware.



CADENAS POUR COUPLEUR / COUPLER LOCKS



1471DAT
3 1/2" x 9/32" dia.

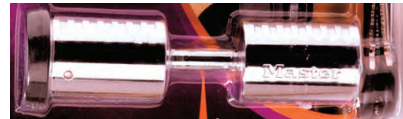

1475DAT
7/8" x 9/32" dia.



2999DAT
Tête articulé 5/8". Plaqué chrome. Couvert pour protéger le cylindre contre la corrosion.
5/8" swivel head. Chrome plated. Weather cover protects from corrosion.



3784DAT
Pour coupleur de remorque 2 5/16". Couvert pour protéger la serrure contre l'humidité et la saleté.
Fits 2 5/16" trailer couplers. Keyway cover protects from moisture and dirt



379ATPY
S'ajuste aux coupleurs de 1 7/8", 2" et 2 5/16". Cylindre avec serrure fonctionnant avec la même clé. Mécanisme fort qui résiste aux crochétages. Facile à installer et à retirer. Résistant à la rouille et à la corrosion.
Fits 1 7/8", 2", and 2 5/16" couplers. Rekeyable cylinder for keyed alike convenience. Advance locking mechanism resists picking and prying. Easy to install and remove. Resists rust and corrosion.



379DAT
1 7/8" - 2" - 2 5/16"
NOIR

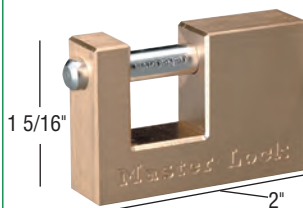

605DAT
Laiton / Brass
1 5/16" x 2"



378DAT
2 5/16"



37D
Acier renforcé
Armored steel

BARRURES AJUSTABLES DE COUPLEUR ADJUSTABLE COUPLER LOCKS



2847DATSC
Acier inoxydable / Stainless steel
5/8" - 1" - 2"



1481DAT
Acier inoxydable / Stainless steel

ENS. DE BARRURE / LOCK SET



Incl. cadenas pour coupleur, goupilles avec serrure et coffret de transport. Fonctionnant avec la même clé.
Incl. coupler lock, receiver locks and carrying case. Keyed alike.

3794DAT
Tête articulé / Swivel Head
5/8" - 1/2" • 1 1/4" - 2"

CADENAS 3/8" / HIDDEN SHACKLE LOCKS 3/8"

Idéal pour fourgons et camions / Ideal for vans and trucks



6270
Acier trempé / Hardened steel

6271
Acier moulé renforcé / Die cast reinforced

6270KA-12
Même chose que 6270 sauf fonctionnant avec la même clé. (Paquet de 12)
Same as 6270 except keyed alike. (Pack of 12)

6270KA-3
Même chose que 6270KA sauf paquet de 3
Same as 6270KA except pack of 3

6270KA-6
Même chose que 6270KA sauf paquet de 6
Same as 6270KA except pack of 6



**ENS. DE CADENAS / LOCK SETS
FONCTIONNANT AVEC LA MÊME CLÉ
KEYED ALIKE**

TM32

Coupleur avec 2 1/2" d'espace & cheville 5/8"
Coupler with 2 1/2" span & 5/8" pin

TM33

Coupleur avec 3 1/2" d'espace & cheville 5/8"
Coupler with 3 1/2" span & 5/8" pin

**CADENAS D'ATTELAGE
HITCH LOCKS**



T-2

1/2" dia. x 1 1/2"
Pour / For: 1 1/4" x 1 1/4"

T-3

5/8" dia. x 2 1/2"
Pour / For: 2" x 2"

**BARRURE POUR RECEVEUR
RECEIVER LOCKS**



TRiTR125

Pour / For: 1 1/4" x 1 1/4"

**BARRURE POUR BATEAU
WATERCRAFT LOCK**



TRiT6

5 1/2" x 1/2"

**GOUPILLE RONDE & SERRURE
ROUND PIN & LOCK**



TRiTS32

Acier inoxydable / Stainless steel
Pour / For: 1 1/4" & 2"

BARRURES DE COUPLEUR / COUPLER LOCKS



TC1

7/8" d'espace
7/8" span

TC2

2 1/2" d'espace
2 1/2" span

TC3

3 1/2" d'espace
3 1/2" span



TRiSXTC2

Acier inoxydable / Stainless steel
2 1/2" d'espace / 2 1/2" span

**CADENAS DE PORTE
DOOR PADLOCK**



TRITRP170

Cadenas en acier inoxydable
round de 70mm
Manille de 10mm
Stainless steel
70mm round padlock
10mm shackle

**BARRURES POUR CAMLOCK
CAMLOCK LOCK**



TRiTHPXL

Cadenas 3/8"
Round lock 3/8"

**ENS. DE MONTAGE TRIPLE PLAQUÉ CHROME
TRIPLE CHROME PLATED DOOR HASP**



TRiTHSP2C

**BARRURE DE COUPLEUR
ANTICLIQUETIS
ANTI-RATTLE LOCKING PIN**



TRiTAR300

Cheville verrouillable anticliquetis
en acier inoxydable
Antirattle stainless steel locking pin
Pour / For: 1 1/4" & 2"

**BARRURES DE COUPLEUR
UNIVERSELLES
UNIVERSAL COUPLER LOCKS**



Manille en acier 5/8"
5/8" steel shackle

UMAX50

Matricé / Die-cast

UMAX100

Acier renforcé
Solid hardened steel



**COUPLEUR À
GACHETTE DELUXE
DELUXE COUPLER TRIGGER**

Idéal pour les portes de
remorque et boîtes de camion
Ideal for trailer doors &
cargo boxes

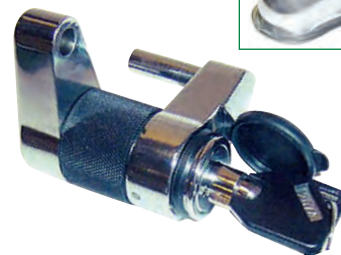

TMC10W

Fait sur coupleurs de 7/8" d'espace
Fit couplers up to 7/8" span



BARRURE POUR 5^E ROUE / 5TH WHEEL LOCK



TRiTFW55

Fait d'acier robuste. Résistant aux intempéries. Inclut 3 clés, dont une avec mini lumière. Facile à installer.
Made of heavy gauge steel. Weatherproof. Includes 3 keys, one with mini flashlight. Easy to install.

BARRURE POUR DISQUE 8MM AVEC ALARME ALARMED ROTOR/DISC LOCK 8MM



TRiAL88
 Cheville verrouillable
 Lock pin



BARRURE DE SÉCURITÉ POUR ANNEAU DE REMORQUAGE LUNETTE TOW RING SECURITY LOCK



TRiTLR51

S'ajuste à un diamètre intérieur de 2 7/8". Fait d'un alliage de métal ultra robuste. Résistant aux intempéries. Inclut 2 clés. Facile à installer.
Fits 2 7/8" inside diameter. Made of heavy duty metal alloy. Weather resistant. Includes 2 keys. Easy to install.

BARRURE POUR MOTEUR HORS-BORD OUTBOARD MOTOR LOCK



TRiB610
 Fait d'acier de forte densité
 Heavy metal gauge steel



CÂBLES / CABLES



TRiD815
 8' L x 15mm



TRiD1510
 15' L x 10mm

BARRURE POUR CÂBLE VERSA-CABLE LOCK



TRiVMAX6
 6' x 10mm
 Usage multiple / Multi-use



CHAÎNE/CÂBLE AVEC ALARME CHAIN / CABLE W/ ALARM



TRiAL1036
 36" x 10 mm
 Résiste à 6 tonnes de tire et une force de coupe de 11 tonnes
Withstands over 6 tons of pull force & 11 tons of cutting force

BARRURE POUR PNEU DE SECOURS SPARE TIRE LOCK



TRiST30
 36" L x 12mm

BARRURE DE ROUE / WHEEL LOCK



Pour : Remorques, Autos, Camions, Equipements de construction, Bateaux, VTT et 4X4
For: Trailers, Cars, Trucks, Construction equipment, Boats, ATV's & 4X4's

TWL100
 S'ajuste sur roues de / Fit on wheels: 10-18"
 Incluant tous les outils et les instructions complètes pour une installation facile.
Includes all tools and complete instructions for easy installations.

BARRURE POUR ROUE / WHEEL CHOCK LOCK

Inclut 3 clés / Includes 3 keys



Pour : Remorques, Autos, Camions, Equipements de construction, Bateaux, VTT, 4X4 et plus
For: Trailers, Cars, Trucks, Construction equipment, Boats, ATV's, 4X4's & more

TRiTCL65
 Universel / Deluxe Universal
 Fermé / Closed: 6"
 Ouvert / Open: 10.5"
 Portée / Reach: 7.25"

TRiTCL75
 Universel / Deluxe Universal
 Fermé / Closed: 7"
 Ouvert / Open: 11.5"
 Portée / Reach: 10.5"



L'ULTIME VERROU ANTIVOL THE ULTIMATE ANTI-THEFT LOCK

L'Ultime protection recommandée par les assureurs ! / The Ultimate protection recommended by insurers



Modèle BR

- Différents modèles qui épousent la forme de la main de remorque.
- Se verrouille et s'enlève en quelques secondes.
- Pèse 10 lb / 4,5 kg.
- Possibilité de clé identique.

Les verrous de la série Ultime, sont les meilleurs sur le marché.

BR Model

- Various models which mould to shape of the Trailer Coupler.
- Locks and removes in a few seconds.
- Weighs 10 pounds / 4,5 kg.
- Possibility of Identical key.

The Ultimate Series, is the best on the market.

Modèle TLS

- Se verrouille et s'enlève en quelques secondes.
- Pèse 5 lb / 2,3 kg.
- Possibilité de clé identique.
- Verrou avec un excellent rapport qualité / prix.

Pour une meilleure protection que la compétition et une sécurité accrue, se référer au modèle BR.

TLS Model

- Locks and removes in a few seconds.
- Weighs 5 pounds / 2,3 kg.
- Possibility of Identical key.
- Lock with excellent value for money.

For a better protection than the competition and the greater security, refer to the BR Model.

Modèle ST

- Se verrouille et s'enlève en quelques secondes.
- Pèse 5 lb / 2,3 kg.
- Avec ce modèle, AMP Lock redéfinit ce que devrait être un verrou standard.
- Clé différentes seulement.
- Ne peut être jumelé à un code existant.

Pour une meilleure protection que la compétition et une sécurité accrue, se référer au modèle BR.

ST Model

- Locks and removes in a few seconds.
- Weighs 5 pounds / 2,3 kg.
- With this model, AMP Lock redefines that should be a Standard lock.
- Only different key.
- Can not be combined to existing code.

For a better protection than the competition and the greater security, refer to the BR Model.



Verrous de remorque Trailer Locks

L'Ultime protection recommandée par les assureurs ! / The Ultimate protection recommended by insurers

VERROU DE BARRE D'ACCOUPEMENT HITCH LOCKS



HLP
Fait d'acier inoxydable
Made with stainless steel



SPHL/SHL
Fait d'acier avec revêtement
Made with coated steel

Modèle / Models	Pour attelages / For receiver
ALHLP12	1 1/4" x 1 1/4"
ALHLP58	2" x 2"
ALHLP583	5/8" Tige / Rod - 3" x 3" motorisé / motorized
ALHLP58418	4 1/8" Tige / Rod
ALHLP58458	4 5/8" Tige / Rod
ALSPHL12	1 1/4" x 1 1/4"
ALSPHL58	2" x 2"
ALSHL12	1 1/4" x 1 1/4"
ALSHL58	2" x 2"

CADENAS DE PORTE DOOR PADLOCKS

- Couvre la totalité de la penture pour une meilleure protection. Pèse 5 lb / 2,3 kg
Aussi disponible plaque de protection **ALTH-02**
- Completely covers the hinge for improved protection. Weighs 5 pounds / 2,3 kg
ALTH-02 Protective Plate also available



ALPDC02KD
Avec revêtement
"ECOAT" et peinture
With "ECOAT" and
paint

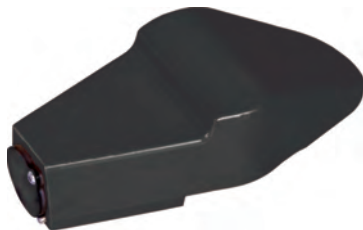

ALPDC02KD
Avec revêtement
"ECOAT"
With "ECOAT"



ALCP1
Unité
Unit

ALCP2
Paquet de 2 avec
clé identique
Pack of 2
Keyed alike

ALCP3
Paquet de 3 avec
clé identique
Pack of 3
Keyed alike

ENSEMBLE D'INSTALLATION INSTALLATION KIT



ALKITAMPBOLT

- Incluant :
Tournevis
Bit Ampbolt
Loctite 263 - 10ml
Mèche 11/32"
Tap 3/8" - 16
- Includes :
One Screwdriver
One Socket
Loctite 263 - 10 ml
One 11/32" Drill Bit
One 3/8" - 16 Tap

Détaillant seulement / Dealer only

BOULON ANTIVOL «AMPBOLT» ANTI-THEFT «AMPBOLT» BOLT



AMPBOLT



AMPBOLT01

Unité / Unit
Paquet de 10
Pack of 10

- Boulon trempé
- Tête à prise spéciale
- Idéal pour sécuriser la main de remorque, la barre d'accouplement de Fifth Wheel, etc.
- Heat Treated Bolt
- Spécial bolthead
- Ideal for Fifth Wheel Couplers Locks, Trailer couplers, etc.



Verrous de remorque Trailer Locks

L'Ultime protection recommandée par les assureurs ! / The Ultimate protection recommended by insurers



Modèles TP et CC

- Différents modèles qui épousent la forme de l'anse, de la main de remorque.
- Pèse 2 lb / 0,9 kg

Voir la table de sélection à la page 336 pour les TP/CC

TP and CC Models

- Various models which mould to shape of the Trailer Coupler Handle.
- Weighs 2 pounds / 0,9 kg

See Lock Selection Table on page 336 for TP/CC

TRIO KIT KIT TRIO

Voir la table de sélection à la page 336 pour les TP/CC / See Lock Selection Table on page 336 for TP/CC



ENSEMBLE CARGO 2 CARGO KIT 2

Voir la table de sélection à la page 336 pour les TP/CC / See Lock Selection Table on page 336 for TP/CC

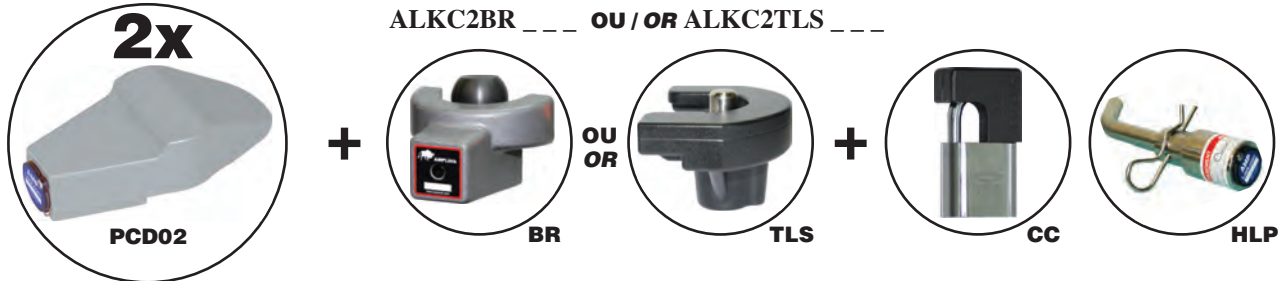

ENSEMBLE CARGO 3 CARGO KIT 3

Voir la table de sélection à la page 336 pour les TP/CC / See Lock Selection Table on page 336 for TP/CC

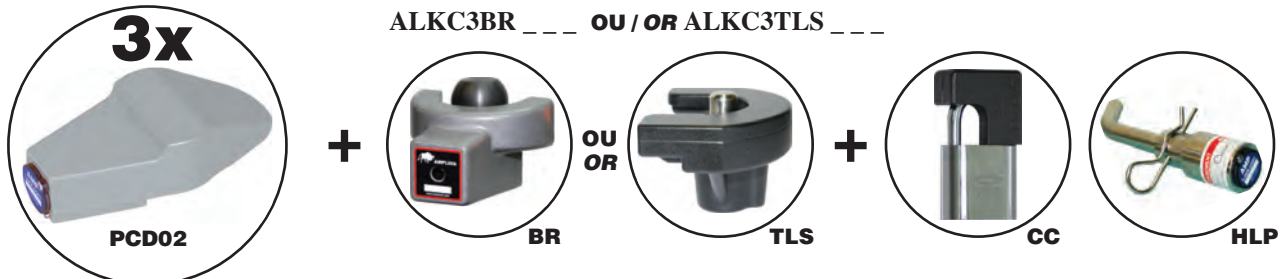



Table de sélection

Trouvez l'ensemble pour votre verrou
AMPLOCK associé à la main de remorque

Lock Selection Table

Find the AMPLOCK kit that
corresponds to the trailer coupler

L'Ultime protection recommandée par les assureurs ! / The Ultimate protection recommended by insurers



Fig #1



Fig #2

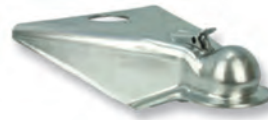

Fig #3A



Fig #3B



Fig #4



Fig #5



Fig #6



Fig #7



Fig #8



Fig #9



Fig #10



Fig #11



Fig #12



Fig #13



Fig #14



Fig #15



Fig #16



Fig #17



Fig #18



Fig #19



Fig #20



Fig #21



Fig #22



Fig #23



Fig #24

Les mains de remorque ne sont pas incluses avec les verrous. / The trailer coupler is not included with the locks.



Table de sélection

Trouvez l'ensemble pour votre verrou
AMP Lock associé à la main de remorque

Lock Selection Table

Find the AMP Lock kit that
corresponds to the trailer coupler

L'Ultime protection recommandée par les assureurs! / The Ultimate protection recommended by insurers

VERROU SEUL / LOCKS ONLY

Modèle de main Coupler Model	CADENAS DE MAIN DE REMORQUE / TRAILER COUPLER LOCKS			CADENAS DE CLANCHE / PUSH LOCKS	
	Ultime BR / Ultimate BR	Standard Plus TLS	Standard ST	Ultime TP / Ultimate TP	Standard Plus CC
FIG #1	ALBR178 / BRP2	ALTLS178 / TLS2	ALST178 / ALST2	ALTP001	ALCC23-1
FIG #2	ALBRP2	ALTLS2	ALST2	N/A	ALCC75-1
FIG #3A	ALBRP2516	ALTLS2516	ALST2516	ALTP005	ALCC50-1
FIG #3B	ALBRP2516	ALTLS2516	ALST2516	N/A	ALCC50-3
FIG #4	ALBRA2 / ALBRA2516	N/A	N/A	N/A	ALCC50-3
FIG #5	ALBRP2	ALTLS2	ALST2	N/A	ALCC75-1
FIG #6	ALBRP2	ALTLS2	ALST2	ALTP001	ALCC23-1
FIG #7	ALBRHT2 / BRHT2516	ALTLS2516T	ALST2516T	N/A	ALCC50-1
FIG #8	ALBRI2516	N/A	N/A	ALTP005	ALRI8032-23
FIG #9	ALBRM2	ALTLS2	ALST2	N/A	ALCC75-2
FIG #10	ALBRG2 / ALBRG2516	N/A	N/A	N/A	ALCC23-1
FIG #11	ALBRB2 / ALBRB2516	N/A	N/A	ALTP007	N/A
FIG #12	ALBRV2	ALTLS2V	ALST2V	N/A	N/A
FIG #13	ALBRP2	ALTLS2	ALST2	ALTP001	ALCC50-1
FIG #14	ALBRP2516	ALTLS2516	ALST2516	ALTP005	ALCC50-1
FIG #15	ALBRU2	N/A	N/A	ALTP010	N/A
FIG #16	ALBRV2S	N/A	N/A	N/A	N/A
FIG #17	N/A	N/A	N/A	ALTP004	N/A
FIG #18	ALBRP2	ALTLS2	ALST2	ALTP011	N/A
FIG #19	ALBRP2	ALTLS2	ALST2	N/A	ALCC50-3
FIG #20	ALBRU2516	N/A	N/A	N/A	N/A
FIG #21	ALBRP2	ALTLS2AC	ALST2AC	ALTP010	N/A
FIG #22	ALBGNA	ALTLSGNA	ALSTGNA	N/A	N/A
FIG #23	ALBRB2516S	ALTLS2516BS	ALST2516BS	N/A	ALCC50-2
FIG #24	ALBRP2516	ALST2516P	ALST2516P	ALTP005	ALCC50-1

ENSEMBLES TRIO ET CARGO / TRIO AND CARGO KITS

Modèle de main Coupler Model	Boule Ball	KIT TRIO / TRIO KIT	KIT TRIO / TRIO KIT	ENS. CARGO 2 / CARGO KIT 2	ENS. CARGO 3 / CARGO KIT 3
		TLS	BR	BR	BR
FIG #1	1 7/8"	ALTTLS178231	ALTBRI178231 ou/or	ALC2BRI178231 ou/or	ALC3BRI178231 ou/or
	2"	ALTTLS2231	ALTBRI2231	ALC2BRI2231	ALC3BRI2231
FIG #2	2"	ALTTLS2751	ALTBRI2751	ALC2BRI2751	ALC3BRI2751
FIG #3A	2 5/16"	ALTTLS2516501	ALTBRI2516501	ALC2BRI2516501	ALC3BRI2516501
FIG #3B	2 5/16"	ALTTLS2516503	ALTBRI2516503	ALC2BRI2516503	ALC3BRI2516503
FIG #4	2"	N/A	ALTBRA2503 ou/or	ALC2BRA2503 ou/or	ALC3BRA2503 ou/or
	2 5/16"	N/A	ALTBRA2516503	ALC2BRA2516503	ALC3BRA2516503
FIG #5	2"	ALTTLS2751	ALTBRI2751	ALC2BRI2751	ALC3BRI2751
FIG #6	2"	ALTTLS2231	ALTBRI2231	ALC2BRI2231	ALC3BRI2231
FIG #7	2"	ALTTLS2T501	ALTBRIHT2501 ou/or	ALC2BRIHT2501 ou/or	ALC3BRIHT2501 ou/or
	2 5/16"	ALTTLS2516T501	ALTBRIHT2516501	ALC2BRIHT251651	ALC3BRIHT251651
FIG #8	2 5/16"	N/A	ALTBRI25168032	ALC2BRI2516802	ALC3BRI2516802
FIG #9	2"	ALTTLS2752	ALTBRI2752	ALC2BRI2752	ALC3BRI2752
FIG #10	2"	N/A	ALTBRI2231 ou/or	ALC2BRI2231 ou/or	ALC3BRI2231 ou/or
	2 5/16"	N/A	ALTBRI2516231	ALC2BRI2516231	ALC3BRI2516231
FIG #11	2"	N/A	ALTBRI207 ou/or	ALC2BRI207 ou/or	ALC3BRI207 ou/or
	2 5/16"	N/A	ALTBRI251607	ALC2BRI251607	ALC3BRI251607
FIG #13	2"	ALTTLS2501	ALTBRI2501	ALC2BRI2501	ALC3BRI2501
FIG #14	2 5/16"	ALTTLS2516501	ALTBRI2516501	ALC2BRI2516501	ALC3BRI2516501
FIG #15	2"	N/A	ALTBRI210	N/A	N/A
FIG #19	2"	ALTTLS2503	ALTBRI2503	ALC2BRI2503	ALC3BRI2503
FIG #21	2"	ALTTLS2AC10	ALTBRI210	N/A	N/A
FIG #23	2 5/16"	ALTTLS2516BS52	ALTBRI2516BS52	ALC2BRI2516BS52	ALC3BRI2516BS52
FIG #24	2 5/16"	ALTTLS2516P501	ALTBRI2516501	ALC2BRI2516501	ALC3BRI2516501



Verrous récréatifs Recreative Locks

L'Ultime protection recommandée par les assureurs ! / The Ultimate protection recommended by insurers



ALLPCVR

- Empêche la traction par des chaînes.
- Empêche la pose sur des attelages modifiés.
- Pèse 11 lb / 5 kg.
- Possibilité de clé identique.

Les verrous de la série Ultime, sont les meilleurs sur le marché.

ALLPCVR

- Prevent traction with chains.
- Prevent fitting of modified hitches.
- Weighs 11 pounds / 5 kg.
- Possibility of Identical key.

The Ultimate Series, is the best on the market.

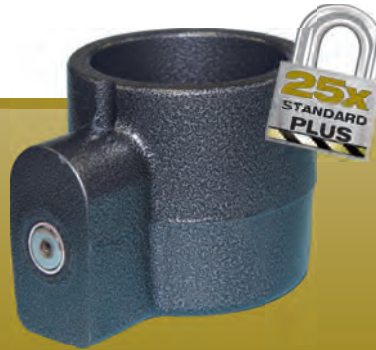

ALPLS

- Se verrouille et s'enlève en quelques secondes.
- Pèse 6 lb / 2,7 kg.
- Possibilité de clé identique.
- Verrou avec un excellent rapport qualité / prix

Pour une meilleure protection que la compétition et une sécurité accrue, se référer au ALLPCVR.

ALPLS

- Locks and removes in a few seconds.
- Weighs 6 pounds / 2,7 kg.
- Possibility of Identical key.
- Lock with excellent value for money.

For a better protection than the competition and the greater security, refer to the ALLPCVR.



ALSP

- Se verrouille et s'enlève en quelques secondes.
- Pèse 6 lb / 2,7 kg.
- Avec ce modèle, AMPLock redéfinit ce que devrait être un verrou standard.
- Clé différente seulement.

Pour une meilleure protection que la compétition et une sécurité accrue, se référer au ALLPCVR.

ALSP

- Locks and removes in a few seconds.
- Weighs 6 pounds / 2,7 kg.
- With this model, AMPLock redefines that should be a Standard lock.
- Only different key.

For a better protection than the competition and the greater security, refer to the ALLPCVR.

VERROUS D'ATTACHE DE «FIFTH WHEEL» FIFTH WHEEL HITCH LOCK



- Empêche d'enlever l'attelage dans la boîte du camion.
- Pèse 2 lb / 0,9 kg
- Prevents Truck Body Hitch removal.
- Weighs 2 pounds / 0,9 kg



TRIO «FIFTH WHEEL» FIFTH WHEEL TRIO

ALLTVR

Ensemble de protection pour la «King Pin», le rail à selette du véhicule et un cadenas REAL (ALRL8032-50) pour la clanche de l'attache de Fifth Wheel.

Fifth Wheel Protection Kit for the Pin, Vehicle Hitch, and includes a REAL Padlock (ALRL8032-50) for the Hitch Latch.



ALLPCVR



ALFLP



ALRL8032-50

*Le cadenas «REAL» ne fonctionne pas sur les attaches «Husky».
*The «REAL» Lock does not work on «Husky» name brand Hitches.



NON DISPONIBLE AU QUÉBEC / NOT AVAILABLE IN QUEBEC



Verrous récréatifs Recreative Locks

L'Ultime protection recommandée par les assureurs! / The Ultimate protection recommended by insurers



ALLPCF



ALSP

- Se verrouille et s'enlève en quelques secondes.
- Pèse 6 lb / 2,7 kg.

Pour une meilleure protection que la compétition et une sécurité accrue, se référer au modèle LPCVR.

- Locks and removes in a few seconds.
- Weighs 6 pounds / 2,7 kg.

For a better protection than the competition and the greater security, refer to the LPCVR Model.



ALLPCF



Pèse 11 lb / 5 kg
Weighs 11 pounds / 5 kg

ALLPCFD



Pèse 18 lb / 8,2 kg
Weighs 18 pounds / 8,2 kg

ALLPCF ALLPCFD

Fabriquée en fonte ductile, empêche la traction par les chaînes et empêche la pose sur des attelages modifiés.

*Deux serrures à haut niveau de sécurité sur la LPCFD.

Made of ductile cast iron and stainless steel to prevent traction with chains and fitting of modified hitches.

*Two high security locks on LPCFD.

Options

Chaîne recouverte d'une gaine fluorescente :

ALCH24 (24") & ALCH36 (36")

- Utile pour le transport,
- Facile à percevoir en reculant.

Stainless steel chain with fluorescent sleeve:

ALCH24 (24") & ALCH36 (36")

- Useful for transportation,
- Easy to see when backing up.

VERROU DE PORTE POUR SEMI-REMORQUE SEMI-TRAILER DOOR PADLOCK



ALPDC02

Couvre la totalité de la penture pour une meilleure protection. Aussi disponible plaque de protection **ALTH-3**.

Pèse 5 lb / 2,3 kg

Completely covers the hinge for improved protection.

ALTH-3 Protective Plate also available.

Weighs 5 pounds / 2,3 kg



ALPRD

Pour une meilleure protection de l'anse.

Pèse 6 lb / 2,7 kg

For improved handle protection.

Weighs 6 pounds / 2,7 kg





Verrous Gooseneck Gooseneck Locks

L'Ultime protection recommandée par les assureurs ! / The Ultimate protection recommended by insurers

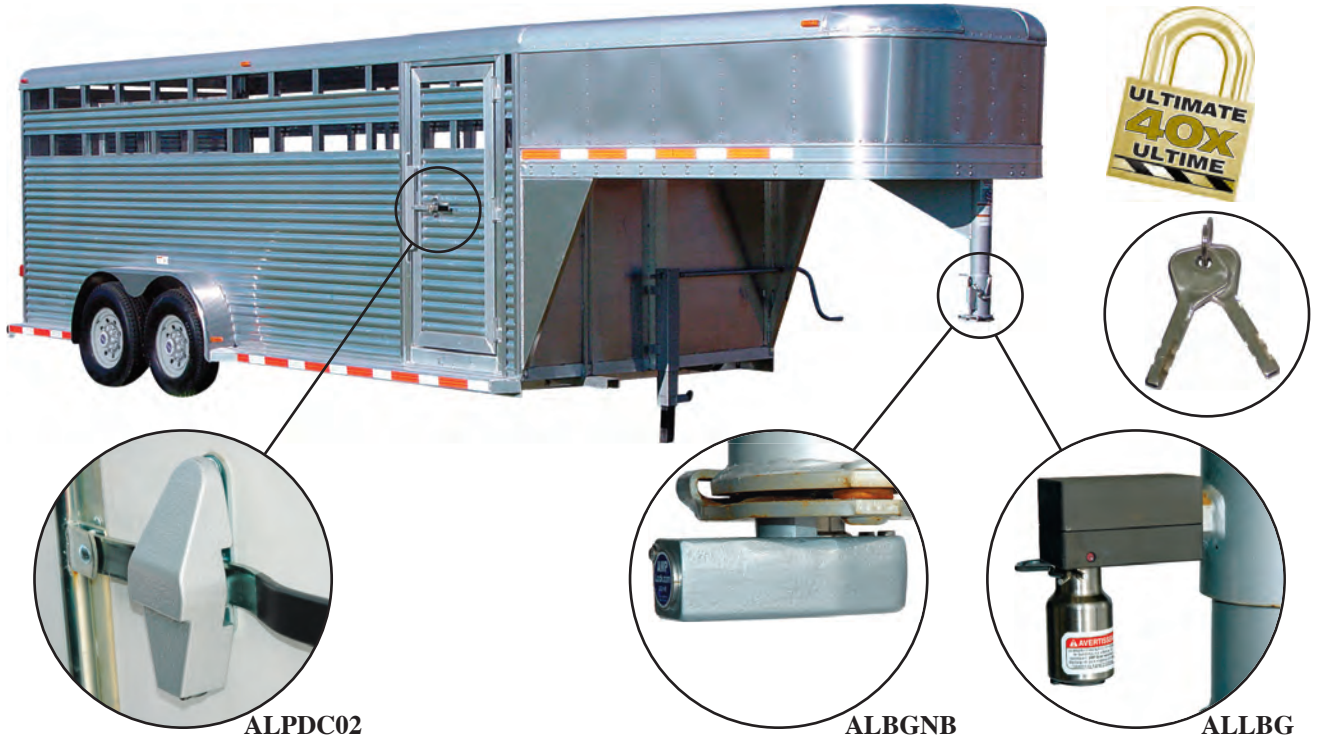

ALPDC02

ALBGNB

ALLBG

TABLE DE SÉLECTION SELECTION TABLE



ALBGNB
BULLDOG



ALBGNA
Atwood



ALBGNF
Fulton

ALBGN-BI
RAM



Pèse 12 lb / 5,5 kg
Weighs 12 pounds / 5,5 kg

VERROUS DE BOULON DU BRAS D'ATTELAGE COUPLER BOLT LOCK



ALLBG

- Empêche d'enlever le bras d'attelage
- Prevents coupler removal.



DUO «GOOSENECK» «GOOSENECK» DUO



- ALDBGNB = ALBGNB + ALLBG
- ALDBGN-BI = ALBGN-BI + ALLBG
- ALDBGNA = ALBGNA + ALLBG
- ALDBGNF = ALBGNF + ALLBG



Verrous divers Miscellaneous Locks

L'Ultime protection recommandée par les assureurs! / The Ultimate protection recommended by insurers

VERROU D'ATTACHE «TYPE ANNEAU» / RING TYPE LOCKS



ALBA212
2 1/2"



ALBA3
3"



Vous pouvez ajouter un HLP AJ pour sécuriser la main ajustable pour plus de protection.
Disponible pour anneau de 2 1/2" et 3" - Pèse 10 lb / 4,5 kg
For added protection, you can add an HLP AJ to secure an adjustable coupler.
Available for rings from 2 1/2" to 3" - Weighs 10 pounds / 4,5 kg

VERROUS DE MOTONEIGE SNOWMOBILE LOCKS

Idéal pour sécuriser le pont de la motoneige. Disponibles en 16" et 18".
Ideal for securing snowmobile tracks. Available in 16" and 18" sizes.



ALSL16
16"

ALSL18
18"

Pèse 4 lb / 1,8 kg
Weighs 4 pounds / 1,8 kg

CÂBLES DE SÉCURITÉ SECURITY CABLES



ALKW40
40"

ALKW60
60"

Fait avec un câble galvanisé 1/2" de diamètre recouvert d'une gaine.
Idéal pour sécuriser les roues de remorque ou de VR, une ou plusieurs motos, etc. Pèse 5 lb / 2,3 kg
Made from 1/2" diameter galvanized cable in a color sleeve.
Ideal for securing a trailer or RV Wheel, one or more motorbike, etc.
Weighs 5 pounds / 2,3 kg

CADENAS REAL REAL PADLOCKS



Cadenas REAL

- Fabriqué en alliage de zinc avec placage chromé.
- Anse en acier trempé.

REAL Padlocks

- Manufactured from a chrome-plated zinc alloy.
- Case-hardened shackle.

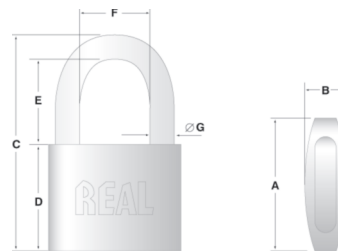

#	A	B	C	D	E	F	G(Ø)
ALRL8032-23	40	21	68	38	23	20	7
ALRL8032-50	40	21	88	38	50	20	7
ALRL8032-75	40	21	113	38	75	20	7
ALRL8033	50	21	86	42	35	22	9
ALRL8034	60	21	95	45	39	29	11



Verrous divers Miscellaneous Locks

L'Ultime protection recommandée par les assureurs ! / The Ultimate protection recommended by insurers

VERROU DE MOTO MOTORBIKE LOCK

ALRL8028

- Fabriqué en alliage de zinc avec plaquage.
- Facile à installer.
- Pèse 2 lb / 0,9 kg.
- Clé différente seulement.

ALRL8028

- Manufactured from a chrome-plated zinc alloy.
- Easy to install.
- Weighs 2 pounds / 0,9 kg.
- Different key only.



SABOTS IMMOBILISATEURS DE ROUES WHEEL CLAMPS



ALWL02-5

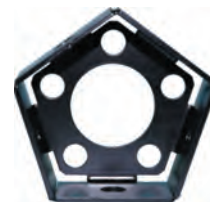

ALWLH-5

ALWL02-5

- S'installe en quelques secondes
- 5 boulons
- Pèse 22 lb / 10 kg
- *N'offre pas le même niveau de protection que les modèles BR.

ALWL02-5

- Install in a few second
- 5 bolts
- Weighs 22 pounds / 10 kg
- *Does not provide the same level of protection as do the BR Models.

ALWLH-5

Pour le rangement

ALWLH-5

For storage

VERROUS AMPLOCK AMPLOCK LOCKS

Verrous pour pôle pliante

ALHLPPB Ce modèle convient aux 2 épaisseurs standards.

ALHLPPB6 (6" d'épaisseur)

- Si la pôle est pliante, il est très important de la sécuriser afin que l'on ne puisse pas enlever les boulons et changer la pôle.

Bolts for folding pole

ALHLPPB This model is suitable for standard 2-ply.

ALHLPPB6 (6 " thick)

- If the pole is collapsible, it is very important to secure it so that we can not remove the bolts and change the pole.



Verrou de moteur de bateau

- Facile à installer
- Niveau de sécurité inégalé
- Sécurise le moteur de bateau et / ou le pied du moteur

Lock Boat Motor

- Easy to install
- Unequalled security level
- Secures the motor boat and / or foot engine



#	Filet du boulon Bolt thread
ALLB51618	5/16 - 18
ALLB71620	7/16 - 20
ALLB1213	1/2 - 13
ALLB1220	1/2 - 20
ALLBM12125	M12 x 1.25
ALLBM12175	M12 x 1.75
ALLB5818	5/8 - 18



ALLBT

Outil pour détruire le verrou à l'aide d'une perceuse (Perceuse non fournie).
Tool for destroying the lock with a drill (Drill not included).



**BARRURE DE ROUE
DE REMORQUE
TRAILER KEEPER LOCK**



TK1000100
Ajustable. Fait pour les roues de 15".
Serrure en laiton et ens. de clés
*Ajustable. Fits wheels up to 15".
Brass lock and key set*

**ASSORTIMENTS DE
QUINCAILLERIE
D'INSTALLATION
ASSORTMENT
INSTALLATION
HARDWARE KITS**

HH49803
Boulons "Carriage", blocs, etc...
Carriage bolts, blocks, etc...

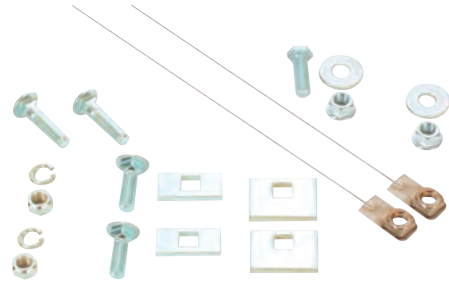

**ENS. DE SUPPORT POUR
CHAÎNE
CHAIN BRACKET KIT**



HH50223
18,000 lbs

**ANNEAU D'ATTACHE À
ENCASTRER
RECESSED TIE-DOWN RING**



J-6000-TDZ
5,000 lbs.

**GOUPILLE À ATTACHE
COUPLER LOCKING PIN**



WGP560
5/16" x 2 1/2"

CHAÎNES DE SÉCURITÉ / SAFETY CHAINS



- Fournit un remorquage plus sécuritaire
- Utilisation recommandée: 2 par attelage
- Maillons soudés ultra résistants
- Provide safer trailing towing
- Recommended use: 2 per hitch
- Heavy duty welded links

13-450-48SL
3/16" x 48" (Zincé)
2,000 LBS

13-455-48SL
1/4" x 48" (Zincé)
5,000 LBS

13-460-48SL
5/16" x 48" (Zincé)
7,600 LBS

**CROCHETS EN "S"
"S" SHAPED HOOKS**



13-200-SL
Crochet 3/8" en "S"
3/8" "S" hook (Zincé)
2,000 LBS

13-201-SL
Crochet 17/32" en "S"
17/32" "S" hook (Zincé)
5,000 LBS

13-202-SL
Crochet 7/16" en "S"
7/16" "S" hook (Zincé)
7,600 LBS

**CROCHETS / HOOKS
10,000 lbs**



V014A
Chrome

V014B
Noir / Black



**MOUSQUETON D'AMARRAGE FORGÉ
FORGED MOORING SNAP**

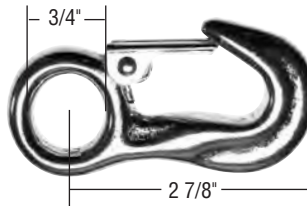

MXV2311-01
3,500 lbs

RAM



**ANNEAUX AVEC MONTURE ET SUPPORTS
FORGED LASHING RINGS WITH MOUNTING BRACKETS**

Avec support / With bracket



Avec support à 2 trous
With 2 hole bracket

DR-12B
1/2" dia. 11,781 lbs



DR-58W
5/8" dia. 18,390 lbs

**TREUIL MANUEL
HOIST PULLER**

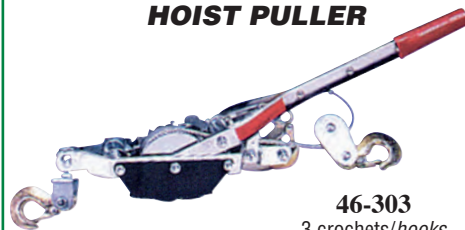

46-303
3 crochets/hooks
2,000KG: 5' / 1,000KG:10'

**ANNEAUX AVEC MONTURE ET SUPPORTS
FORGED LASHING RINGS WITH MOUNTING BRACKETS**

Avec support à 2 trous
With 2 hole bracket



B23
1/4" dia. 1,000 lbs

Avec support / With bracket



B46
3/4" dia. 26,500 lbs



B48
1" dia. 46,760 lbs

**ANNEAU AVEC ANCRAGE PIVOTANT EN MÉTAL
METAL SWIVELLING ANCHOR RING**

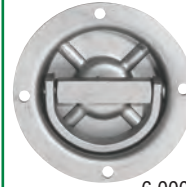

B901
6,000 lbs • 6" dia.

**ANNEAU POUR CORDE À ENCASTRÉ
RECESSED ROPE RING**



B601
Zinc
1200 lbs
3 1/2" x 5" x 3/8"

**MONTAGE DE SURFACE AVEC ANCRAGE
SURFACE ANCHOR MOUNT**



B701SM
265 lbs

**LOQUET À RESSORT
SPRING LATCH**

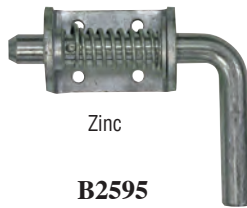

Zinc
B2595
Pour/For: 1/2"

**ENS. DE LOQUET DE SÉCURITÉ
CORNER SECURITY LATCH SET**



B2589B
4 morceaux/pièces

**LOQUETS À RESSORT
SPRING LATCHES**

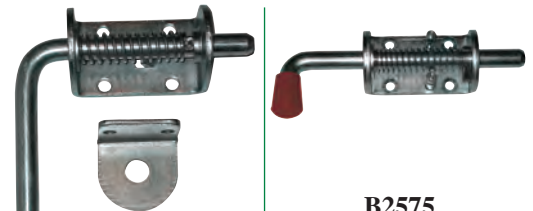

B2595LKB
Pour/For: 1/2"

B2575
Zinc. Pour/For: 1/2"

**ANNEAUX AVEC SUPPORT À 2 TROUS
FORGED LASHING RINGS WITH 2 HOLE BRACKET**



B38ZY
1/2" dia.
11,781 lbs
Zinc jaune
Yellow zinc

**SUPPORTS DE POTEAU
STAKE POCKETS**

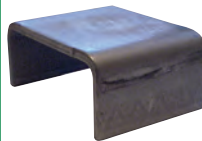

B2373R
Épaisseur: 7/32"
Thickness: 7/32"
Dimension intérieure
Inside dimension:
3 1/2" x 1 1/2"

**ENS. DE CONNECTEUR POUR COIN
CORNER STAKE CONNECTOR SET**



B2591B
4 morceaux
4 pieces

**AUTOMATED
PRODUCTS**

**PINCES DE MONTAGE UNIVERSELLES
UNIVERSAL MOUNTING CLAMPS**



APIDA102
A= 0" à / to 2 1/4"
B= 23/16" C= 1 1/4"

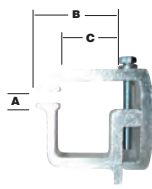

APIAC103U
A= 0" à / to 1 3/8"
B= 2 1/2" C= 1 3/4"

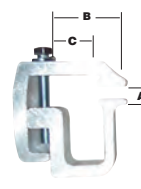

APIKH1U
A= 0" à / to 7/8"
B= 1 3/4" C= 1"



APIAC1031U
A= 0" à / to 1 3/8"
B= 2 1/2" C= 1"

Pour / For
F150 04-07



APIAC108U
A= 0" à / to 1 3/8"
B= 3" C= 1"

Pour / For
F250 SD 99-07

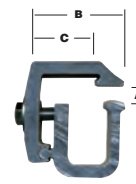

APIAC101U
A= 0" à / to 5/8"
B= 1 1/2" C= 3/4"

**ENS. DE MONTAGE POUR BOÎTE DE CAMION
TRUCK BOX MOUNTING KIT**

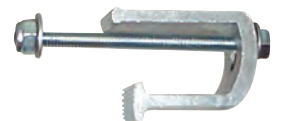

APITB100UM-2



N **CROCHET POUR CHAÎNE DE SURETÉ QUICK-LINK CHAIN HOOK-UP**



HH49132
1/4" • 3,500 lbs

MAILLES QUICK LINKS



HH49131
5/16" • 3,500 lbs
R74602
5/16" • 5,000 lbs

ANNEAU DE SURETÉ POUR CHAÎNE SAFETY CHAIN LOOP



R1962
Class II, III - 5,000 lbs

ANNEAU POUR CHAÎNE CHAIN LOOP



D34141
Class III



CHEVILLE (3/8") & GOUPILLE PIN (3/8") & CLIP

D63243
Pour/For:
Class V titan
receveur 2 1/2"
2 1/2" receiver

GOUPILLE POUR MONTURE "CLEVIS" CLEVIS MOUNT PIN



D5764
1" x 4 1/2"
6,000 / 600 lbs

GOUPILLE D'ATTELAGE HITCH PIN



D55010
5/8" dia. x 2"

CHEVILLE & GOUPILLE PIN & CLIP



HH60030
3/8" dia.
Pour/For:
2 5/8"

GOUPILLE D'ATTELAGE HITCH PIN



HH63203
5/8" dia. • Pour/For: 2"
HH63204
1/2" dia. • Pour/For: 1 5/8"

GOUPILLE AVEC CADENAS J-PIN WITH LOCK



HH63201
Pour attelage: 2"
For receiver: 2"

CHEVILLE & GOUPILLE PULL PIN & CLIP



D63241
1/2"

CHAÎNES / CHAINS



D63034
6', 2,000 lbs
Class I

D63035
6', 5,000 lbs
Class III

CHEVILLES & GOUPILLES PINS & CLIPS

Paquet de 4
Pack of 4



R58053
Chevilles & goupilles
pour attelage de 5^e roue
Pins & Clips for fifth wheel hitch

SUPPORT À PNEU / SPARE TIRE CARRIER

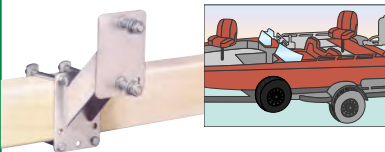

STC1000101
Pour support allant jusqu'à 3" x 4"
Fits crossbar up to 3" x 4"

CROCHET DE REMORQUAGE TOW HOOK



D63044
GWR 10,000 lbs
13" x 5.5" x 2.5"

SUPPORT À PNEU SPARE TIRE CARRIER



Attache le pneu au support de la remorque.
Fait pour les roues de 8" à 15".
Bolts tire to trailer crossbar. Fits 8" to 15" wheels

ETC0101
Emballé / Packaged

PORTE-PNEU ROBUSTE À SOUDER HEAVY DUTY WELD ON TIRE CARRIER



581900
Se monte sur une structure de 2", 3" et 4".
Fait sur les jantes avec 4 et 5 goujons.
Mounts to 2", 3" and 4" trailer frames. Fits 4 and 5 bolt lug rims.

GOUPILLE À ATTACHE DE REMPLACEMENT REPLACEMENT SNAPPER PIN



D63020
1/4"



ENSEMBLE D'ANCRAGE POUR CAMION TRUCK TIE DOWN ANCHOR KIT



SB18603
7 points d'ancrage
7 mounting points



- Sécurise plusieurs objets dans la caisse simultanément
- Avec ses multiples points d'ancrage, il permet de sécuriser des objets volumineux
- Conçu d'acier roulé à froid 3/16
- Design discret
- Quincaillerie robuste Grade 8 - incluse
- Perçage requis
- Texture en 2 étapes au fini noir mat poudré
- Peut être installé sur le devant ou l'arrière des panneaux de la caisse

L'ensemble contient / Kit contains :

- (2) Ancrages / Tie downs
- (2) Courroies / Straps

- Secure multiple items in the bed simultaneously
- Multiple leveraging anchor points to secure bulky items.
- Manufactured from 3/16 cold rolled steel
- Low profile design
- High strength Grade 8 Hardware - included
- Some drilling required
- Two Stage texture matte black powder coat finish
- Can be used on front or rear of bed upright panels



Erickson

POINTS D'ATTACHE / ANCHOR POINTS

Vendu à la paire / Sold in pairs
Anneau puissant. Fixation rétractable noire
Patented heavy duty bull ring. Black retractable anchor



- Fermoir à pression
- Sans perçage
- Capacité: 1,000 lbs
- Oeil en acier inoxydable
- Snaps up, snaps down
- No-drill Installation
- 1,000 lbs capacity
- Stainless Steel Eye

E4001

CHEVY - GMC - DODGE - FORD F Series - TOYOTA Tundra



E09094

Hide-A-Hook - 1,200 lbs
Vendu à la paire / Sold in pairs



Vendu à l'unité
Sold per unit

E51007
Zinc



Vendu à l'unité
Sold per unit

E51008
Chrome

PILOT™

HIGHLAND™ The Pro's Brand!



POINTS D'ATTACHE ANCHOR POINTS

Vendu à la paire / Sold in pairs

PWTD-810
Chrome

Système à pression / Push up system



POINT D'ATTACHE / ANCHOR POINT

Vendu à l'unité / Sold per unit

HG92522
Chrome

CHEVY Silverado - GMC Sierra - DODGE Ram

Scavenger Hooks®

PUTCO™ INCORPORATED

extang

ANNEAUX D'ATTACHE EN ACIER INOXYDABLE STAINLESS STEEL HOOK TIE DOWNS



Capacité - 350 lbs - Capacity

502001
Ens. de 4 / Set of 4

POINTS D'ATTACHE ANCHOR POINTS

Vendu à la paire / Sold in pairs



99901P

Système à pression / Push up system
Capacité - 600 lbs - Capacity

POINTS D'ATTACHE ANCHOR POINTS

Vendu à la paire / Sold in pairs

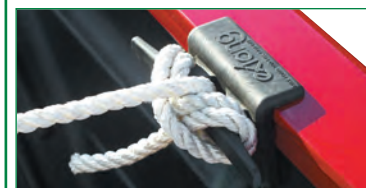

EX1932

Polymère. S'installe sans perçage.
Polymer. No drill installation.
Capacité - 500 lbs - Capacity

Les codes en ROUGE indiquent un item discontinué à quantité limitée / Codes in RED indicate a limited quantity discontinued item

Erickson

SUPPORT POUR ROUE DE SECOURS SPARE TIRE BRACKET



E77316
Plaqué zinc brillant
Bright zinc plated

COURROIE POUR TREUIL WINCH STRAP



E53100
2" x 27'
5,000 lbs

SANGLE D'AJUSTEMENT ADJUSTABLE TIRE STRAP



E58522
3300 lbs CTS (Charge de travail sécuritaire).
Inclut le rochet avec verrou de sécurité. Crochet double en "J" de 2" sur le côté court.
3300 lbs safe working load limit. Includes ratchet with safety hook. 2" double J-Hook on short end.

ATTACHES À ROCHET / RATCHET TIE DOWNS

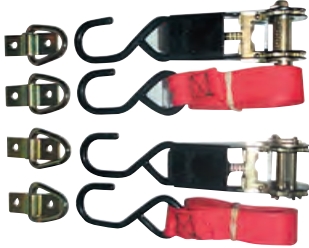

E01408
2 de / of 1" x 10'
500 lb.
4 crochets / 4 hooks

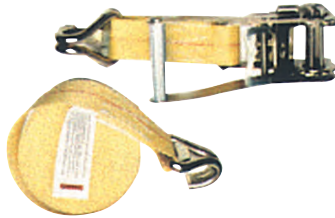

E51300
1" x 15' - 1,200 lb
Noir / Black

E52300
2" x 22' - 2,500 lb
Bleu / Blue

E51316
1" x 15' - 3,000 lb
Jaune / Yellow

E58627
2" x 27' - 3,300 lb
Jaune / Yellow

COURROIE DE REMORQUAGE TOW STRAP



E59200
2" x 15' - 8,500 lb.

COURROIES D'ATTACHE TIE DOWN AND UTILITY STRAPS



E51200
1" x 15'
750 lb

RAIL EN "O" / "O" TRACK



E59133
18" • Avec 2 anneaux
18" • With 2 rings.

ANNEAU À CÂBLER / ROPE TIE-OFF



E59131
4000 lb

MINI TREUIL / MINI WINCH

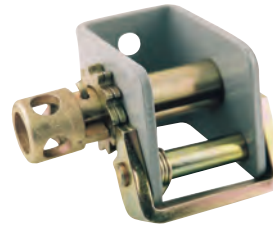

E52804
2"
10,000 lb

BARRE CARGO / CARGO BAR



E08906
88" à 103" (Lever)
88" to 103" (Lever)

ANNEAU AMOVIBLE / REMOVABLE RING



E59093
5,000 lb



ATTACHES À ROCHET / RATCHET TIE DOWNS



EXL82019HD
1" x 15' • 1000 lb.
Rouge. Ens. de 4.
Red. Set of 4.

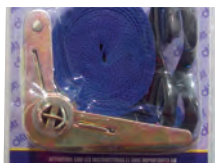

SA651
1" x 15' • 1000 lb.
Bleu. Vendu à l'unité.
Blue. Sold per unit.

PARE-CHOC DE CAOUTCHOUC POUR ARRÊT DE PORTE RUBBER BUMPER FOR DOOR STOP



J-B1
2 1/2
Noir / Black



BubbaRope®

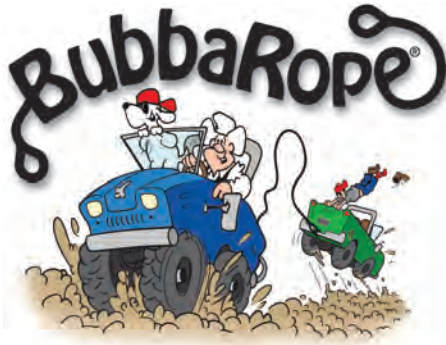

100% corde en nylon tressé double. Revêtement en polymère d'uréthane. Commercialement épissée et saisi aux deux extrémités. Résiste à l'eau, au abrasion et au rayon UV.

100% double braided nylon rope. Urethane polymer coating. Commercially spliced and seized at both ends. Water, abrasion and UV resistant.



Gator-ize est une protection supplémentaire qui est appliquée sur les points d'usure de toute les grandeur de corde "Bubba Rope". Il est fabriqué à partir d'un revêtement en polymère d'élastique de haute performance qui ressemble un peu à la peau d'un alligator. Gator-ize is added protection that is applied to the wear points of any size Bubba Rope. It's made from a high performance elastic polymer coating that looks a little like the tough skin of an alligator.

CORDES DE RECOUVREMENT / RECOVERY ROPES

BUBBA



BUB176660BLG

7/8" x 20'

Résistance à la rupture: 28,600 lb
Breaking strength: 28,600 lb

Vient avec un sac de sport en maille pour faciliter le transport et le stockage
Comes with a mesh duffel bag for easy carrying and storing

BIG BUBBA



BUB176720ORG

1 1/4" x 30'

Résistance à la rupture: 52,300 lb
Breaking strength: 52,300 lb



Vient avec un sac de sport en maille pour faciliter le transport et le stockage
Comes with a mesh duffel bag for easy carrying and storing

JUMBO BUBBA



BUB176730GRG

1 1/2" x 30'

Résistance à la rupture: 74,000 lb
Breaking strength: 74,000 lb

Sac de sport et sangle avec velcro inclus.
Duffel bag and velcro wrap strap included.

LIL' BUBBA



BUB176650YWG

1/2" x 20'

Résistance à la rupture/Breaking strength: 7,400 lb

Sac de sport et sangle avec velcro inclus.
Duffel bag and velcro wrap strap included.

ATTACHES / TIE DOWNS

BUB177050

1" x 6'

Résistance à la rupture: 1,760 lb
Breaking strength: 1,760 lb



MANILLES "CROSBY" CROSBY SHACKLES

BUB191460
BUB191500
BUB191520
BUB191540

Grandeur Size	Charge* (tonnes) WLL* (tons)	Dia Goupille Pin dia.	Poids Weight
1/2"	2.00	.63	.72 lb
3/4"	4.75	.88	2.35 lb
7/8"	6.50	1.00	3.62 lb
1"	8.50	1.13	5.03 lb

*Limite de charge de travail/Working load limit

PROTECTEUR D'ARBRE / TREE PROTECTOR



BUB176000OR

Grandeur/Size: 10'
Résistance à la rupture: 58,000 lb
Breaking strength: 58,000 lb



Sac de sport et sangle avec velcro inclus.
Duffel bag and velcro strap included.

PROTECTEURS POUR CORDE CHAFE GUARDS



Protège votre corde Bubba d'entrer en contact direct avec des surfaces dures ou abrasives.
Protects your Bubba rope from coming in direct contact with hard or abrasive surfaces.

BUB175992
BUB175993
BUB175994
BUB175995

Corde/Rope	Grandeur/Size
Lil Bubba	2'
Bubba	2'
Big Bubba	2'
Jumbo Bubba	3'



ACCESSOIRES POUR SANGLE / WEBBING ACCESSORIES
2 PAR EMBALLAGE / 2 PER PACKAGE



Ki15427
Courroie pour poignée
Handle Strap



Ki15471
Boucle souple
Soft Loop

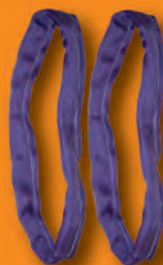

Ki15508
Kwik Strap



Ki15657
Fleece Mate



SANGLE DE HAUTE QUALITÉ / WEBBING & HARDWARE BEYOND COMPLIANT

2 PAR BOÎTE / 2 PER BOX • CHARGE MAXIMALE / WORKING LOAD LIMIT: 835 lbs./380 kgs.

CINTCHTITE 1



Ki15464
1" x 5' Tie-down

- Boucle à came permet un verrouillage rapide et efficace, appuyez et relâchez, facile à utiliser.
- Aircraft cam buckle allows fast and efficient locking with easy-to-use press and release.



CINTCHTITE 2



Ki15465
1" x 5' Tie-down

- Facile à utiliser, resserrement rapide du boucle à cliquet et barre de relâchement avec une main.
- Easy-to-use quick tightening ratchet buckle and one-hand release bar.



CINTCHTITE 3



Ki15466
1" x 6' Tie-down

- Construit de manière à protéger votre peinture et accessoire en chrome.
- La sangle est faite d'un matériel qui absorbe les chocs
- Built in Soft Loop to protect your paint and chrome.
- Shock absorbing sling type material



CINTCHTITE 6

CHARGE MAXIMALE / WORKING LOAD LIMIT: 1670 lbs./750 kgs.

Ki15470
2" x 6' Tie-down



- Conçu avec des sangles de 2" pour l'industrie du camionnage.
- Designed with 2" webbing and engineered for the trucking industry.



**SANGLE DE REMORQUAGE
TOW STRAP**

POUR LA NEIGE ET LA BOUE / SNOW AND MUD

Ki15543

VTT & Motoneige / ATV & Snowmobile

Charge maximale / working load limit : 835 lbs./380 kgs.





CALE DE ROUE / WHEEL CHOCK



Ki80014

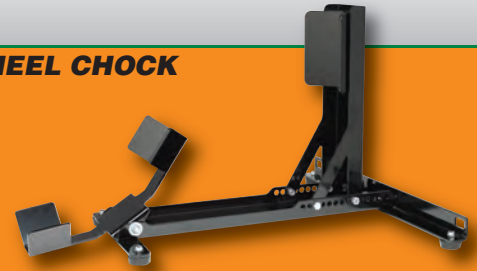

SANGLES DE REMORQUAGE D'URGENCE / EMERGENCY TOW STRAPS



Ki15151
1 3/4" x 15'
Charge maximale
Working load limit
3,300 lbs / 1500 kgs



Ki15520
2" x 20'
Charge maximale
Working load limit
5,000 lbs / 2270 kgs

Ki15503
3" x 25'
Charge maximale
Working load limit
8,000 lbs / 3630 kgs

Ki15504
4" x 20'
Charge maximale
Working load limit
10,667 lbs / 4840 kgs

**COUVRE ROCHET EN VINYLE
VINYL RATCHET COVER**



Ki9064-1PK



Ki15531
Boucle à cliquet
avec sangle de 12'
Ratchet buckle
with 12' web
Charge maximale
Working load limit
500 lbs / 230 kgs



Ki15532
Boucle à came
avec sangle de 6'
Cam buckle
with 6' web
Charge maximale
Working load limit
400 lbs / 185 kgs



**RAIL GLISSIÈRE
POUR TREUIL
STEEL WINCH TRACK**

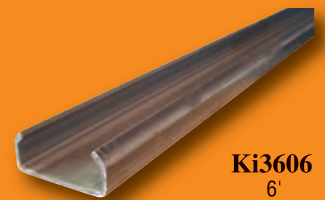

Ki3606
6'



**SANGLE AVEC
CHAÎNE / CROCHET
STRAP W/ CHAIN
ANCHOR**

Ki323040
Capacité / Capacity : 5,400 lbs
Sangle / Strap : 3" x 30'



**SANGLE AVEC
CROCHET PLAT
STRAP WITH FLAT
HOOK**

Ki323021
Capacité / Capacity : 5,400 lbs
Sangle / Strap : 3" x 30'



**PROTECTEUR D'ARBRE
TREE SAVER**



Ki15461
6' L x 4" W

Charge maximale / Working Load Limit:
Panier / Basket: 11,000 lbs / 5000 kgs
Sangle / Choker: 5,280 lbs / 2395 kgs

**RAIL D'ARRIMAGE (SÉRIE E)
HORIZONTAL TRACK (SERIE E)**

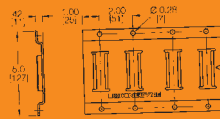

Ki43001
Galvanisé / Galvanized.
10', 16.0 lbs, 12ga.



**TREUIL BARIL
WEBBING WINCH**



Pour courroie de 3" & 4"
For 3" & 4" strap

Ki3820SPC
4 1/2"

**SUPPORT À MADRIER
WOOD BEAM SOCKET**



Ki1845

**COURROIE AVEC ANNEAU ET RESSORT
ROPE TIE-OFF WITH SPRING**



Ki660001
2" x 6", 835 lbs

TIGE D'ACIER / WINCH BAR



Ki37031

VÉRINS / JACKS



DRV20000303
Capacité/Capacity: 2000 lb.
Élévation/Lift: 9" à/to 23"
Course/Travel: 14"
Peint noir/Painted black
Poignée sur le côté/Side handle



D1401020303
Capacité/Capacity: 2,000 lb.
Élévation/Lift: 10 4/10" à/to 20 4/10"
Course/Travel: 10"
Poignée sur le côté / Sidewind



D1400400303
Capacité/Capacity: 2,000 lb.
Élévation/Lift: 11" à/to 21"
Course/Travel: 10"
Poignée sur le dessus / Topwind



1401140303
Capacité/Capacity: 2000 lb.
Élévation/Lift: 11" à/to 21"
Course/Travel: 10"
Peint noir/Painted black
Poignée sur le dessus/Topwind



D1401080303
Capacité/Capacity: 2,000 lb.
Élévation/Lift: 14 4/10" à/to 29 4/10"
Course/Travel: 15"
Poignée sur le côté / Sidewind



D1401200303
Capacité/Capacity: 2,000 lb.
Élévation/Lift: 14 1/2" à/to 29 1/2"
Course/Travel: 10"
Poignée sur le dessus / Topwind



Électrique / Electric
D500198
Capacité/Capacity: 2,500 lb.
Élévation/Lift: 8 1/2" à/to 26 1/2"
Course/Travel: 18"
Disjoncteur d'intégré. Vient avec une poignée manuelle en cas de perte de courant.
Integrated circuit breaker. Works in case of power loss with supplied manual override crank handle.



D1400600303
Capacité/Capacity: 5000 lb.
Élévation/Lift: 10.8" à/to 25.8"
Course/Travel: 15"
Peint noir/Painted black
Poignée sur le dessus/Topwind



D1401480303
Capacité/Capacity: 5000 lb.
Élévation/Lift: 14.7" à/to 29.7"
Course/Travel: 15"
Peint noir/Painted black
Poignée sur le dessus/Topwind



D1401440303
Capacité/Capacity: 5,000 lb.
Élévation/Lift: 15 1/2" à/to 30 1/2"
Course/Travel: 15"
Poignée sur le côté/Sidewind



D1400800383
Capacité/Capacity: 8,000 lb.
Élévation/Lift: 22 9/10" à/to 51 1/2"
Course/Travel: 15"
Poignée sur le dessus/Topwind
Dropleg ajustable avec course additionnelle de 13.6"
Adjustable Dropleg w/Additional Travel of 13.6"



1400850383
Capacité/Capacity: 8,000 lb.
Élévation/Lift: 25 2/10" à/to 53 8/10"
Course/Travel: 15"
Poignée sur le côté/Sidewind
Dropleg ajustable avec course additionnelle de 13.6"
Adjustable Dropleg w/Additional Travel of 13.6"



1400980376
Capacité/Capacity: 12,000 lb.
Élévation/Lift: 28 1/4" à/to 54 1/4"
Course/Travel: 26"
Fini peint gris/Gray painted finish
Poignée sur le côté/Sidewind
Poignée vers le devant/Pin to the front
Drop Leg - Pas de ressort/No spring

FULTON

VÉRINS / JACKS



XP100301
 Capacité/Capacity: 1200 lb.
 Élévation/Lift: 12 3/4" à/to 22 3/4"
 Roue de/Wheel: 6"
 Rotatif/Swivel
 Fait jusqu'à/Fits up to: 3" x 5"
 Course/Travel: 10"
 Poignée sur le côté/Side handle
 Zinc
XP100101
 Même chose que XP100301
 mais dans une boîte
 Same as XP100301
 but in a box



XP150101
 Capacité/Capacity: 1,500 lb.
 Élévation/Lift: 12 3/4" à/to 22 3/4"
 Roue de/Swivel wheel: 8"
 Rotatif/Swivel
 Fait jusqu'à/Fits up to: 3" x 5"
 Zinc

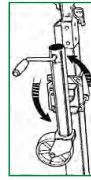

Incl.: Quincaillerie de montage soudé
 Incl.: Weld-on mounting hardware
 Frein non inclus / Brakes not included

1413020134
 Capacité/Capacity: 1,600 lb.
 Élévation/Lift: 18" à/to 28"
 Course/Travel: 10"
 Roue double / Double wheel: 7"
À boulonner/Bolt-on

1413060334
 Capacité/Capacity: 1,600 lb.
 Élévation/Lift: 13" à/to 23"
 Course/Travel: 10"
 Roue double/Double wheel: 7"
À souder/Weld on

Incl.: Quincaillerie de montage soudé
 Incl.: Weld-on mounting hardware
 Frein non inclus / Brakes not included



1413050334
 Capacité/Capacity: 1,600 lb.
 Élévation/Lift:
 14 1/2" à/to 24 1/2"
 Course/Travel: 10"
 Roue de/Wheel: 7"
À souder/Weld on

0928063-00
 Quincaillerie de montage
 boulonné. Pour 3" x 4".
 Bolt-on mounting hardware.
 For 3" x 4" frame.



1413210334
 Capacité/Capacity: 2,000 lb.
 Élévation/Lift: 24" à/to 37"
 Poignée sur le côté/Sidewind
 Course/Travel: 13"
 Petit pied de vérin/Footplate: 7" dia.
 À souder/Weld on
 Quincaillerie boulonnée
 Bolt-on hardware: 4"
 Le raccordement unique
 de la boule et douille entre le vérin
 et son pied permet de s'adapter
 aux surfaces inégales.

Unique ball and socket connection between jack
 and footplate allows for whatever articulation is
 required to accommodate uneven surfaces.



FUL158452
 Capacité/Capacity: 2,000 lb.
 Élévation/Lift: 14 1/2" à/to 29 1/2"
 Fini à l'apprêt/Primer finish
 Support/Mount: 2" dia.
 Course/Travel: 15"
 Cheville/Pin: 9/16"



FUL178112
 Capacité/Capacity: 5,000 lb.
 Élévation/Lift: 15" à/to 29"
 Fini à l'apprêt/Primer finish
 Support 2" dia./2" dia. mount
 Course/Travel: 14"
 Cheville/Pin: 9/16"



FUL178201
 Capacité/Capacity: 5,000 lb.
 Élévation/Lift: 10" à/to 20"
 Fini à l'apprêt/Primer finish
 Support 2" dia./2" dia. mount
 Course/Travel: 10"
 Cheville/Pin: 9/16"



STABILISATEUR STABILIZER

SJ40324
 Capacité/Capacity:
 3,000 lb.



CRIC / JACK



SB2722
 Capacité/Capacity: 7,000 lb.
 Élévation/Lift: 50"
 Poignée d'acier amovible/Steel removable handle



CRIC / JACK



148700
 Capacité/Capacity: 7,000 lb.
 Élévation/Lift:
 48" à/to 83"
 Course/Travel: 35"



VÉRINS / JACKS



**VÉRIN ÉLECTRIQUE
ELECTRIC JACK
12 VOLTS**

500185
Vérin à haut rendement
Heavy duty jack
4,000 lb
Élévation 17"
Travel 17"



195356
5,000 lb
Support 2" dia.
Cheville 5/8".
15.1" à 30.1" d'élévation
5,000 lbs.
2" dia. mount. 5/8" pin
15.1" to 30.1" of lift



FUL190754
8,000 lb.
Vérin patte extensible,
prise côté
*Jack drop leg,
Sidewind*
Course/Travel : 15"

FUL190704
8,000 lb.
Vérin patte xus
*Jack drop leg,
Topwind*
Course/Travel : 15"



DROP LEG



FUL182304
12,000 lb.
Élévation / Lift :
12 1/2" à/ to 22 1/2"
Poignée sur le dessus
Top handle



FUL182815
12,000 lb.
Vérin prise latérale,
patte extensible,
poignée devant.
*Jack sidewind, drop
leg, pin to the front*
Poignée non incluse
Handle not included

HAUT RENDEMENT HEAVY DUTY



182800
12,000 lb
27.6" à 53.6" d'élévation
12,000 lbs.
27.6" to 53.6" of lift
Poignée 015181 non incluse
Handle 015181 not included

015181
Poignée pour vérins
12,000 lb.
Fini à l'apprêt
*Jack handle for 12,000 lbs jacks.
Primer finish*

MOTEUR POUR VÉRIN ÉLECTRIQUE 12 VOLTS MOTOR FOR ELECTRIC JACK 12 VOLTS

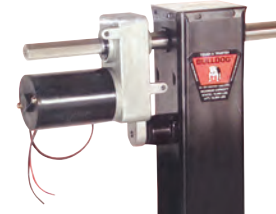

FUL1824200100
Pour vérins 12,000 lb. 1 vitesse.
For 12,000 lbs jacks. 1 speed.

BOUTON DE REMPACEMENT RED KNOB



FUL500246
Série/Series: 150-160-170



500180
Vérin avec poignée dessus
série 150-160-170
*Topwind crank serie
#150-160-170*



FUL500171
Poignée latérale. 7000 lb.
Radius 8.5".
*Sidewind. 7000 lbs.
8.5" radius.*



FUL800075
Cap.: 12,000 lb.
Poignée sur le dessus (courte)
Top handle (Short)



FUL093301S00
Poignée prise latéral vérin
*Handle kit sidewind
800-1200 lb*



VÉRIN ÉLECTRIQUE 12 VOLTS 12 VOLTS ELECTRIC JACK



AW80236
1,500 lb. • Vérin léger/*Lightweight jack*
Élévation à la minute/*Lift per minute: 4"*
A: 10 1/8". B: 14 3/8". C: 24 7/8". D: 39 1/4".

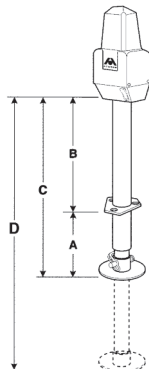

VÉRIN ÉLECTRIQUE ELECTRIC JACK



JET-3500
Capacité/*Capacity: 3,500 lb.*
Course/*Travel: 18"*
Lumière à DEL/*LED light*
Connection 10 jauges avec fusible 30 ampères
10 gauge connection with 30 amp fuse



VÉRIN / JACK



14-0124
 Capacité/Capacity: 2,000 lb.
 Course/Travel: 14"
 Poignée sur le côté droit
 Handle on the right side
 Peint noir/Painted black



VÉRIN / JACK



BUT28110CU
 Capacité/Capacity: 50,000 lb.
 Élévation/Lift: 33" à/ to 52 1/2"
 2 vitesses/speeds 14"
 Vendu à la paire/Sold in pairs
 Manivelle et barre de traverse
 Crank handle and connecting shaft

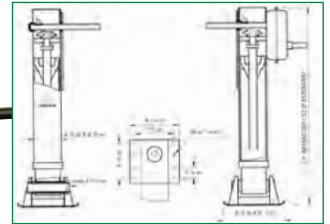

VÉRINS / JACKS



DROP LEG

B0091340
 Capacité/Capacity: 7,000 lb.
 Élévation/Lift: 25" à/ to 53 9/16"
 Course/Travel: 24"
 Pied de 6" x 8" inclus
 6" x 8" foot included
 Fini peint noir/Black finish



DROP LEG

B0091310
 Capacité/Capacity: 7,000 lb.
 Élévation/Lift: 22 5/8" à/ to 51 3/8"
 Course/Travel: 26"
 Pied de 6" x 8" inclus
 6" x 8" foot included
 Fini peint noir/Black finish



VÉRINS / JACKS



EJ10000301
 Capacité/Capacity: 1,000 lb.
 Élévation/Lift: 12.8" à/ to 22.8"
 Roue/Wheel: 6"
 Course/Travel: 10"

EJ10000101
 Même chose que EJ10000301
 mais dans une boîte
 Same as EJ10000301
 but in a box



EA20000303
 Capacité/Capacity: 2,000 lb.
 Élévation/Lift: 8" à/ to 22 1/4"
 Course/Travel: 14"
 Poignée sur le dessus/Topwind
 Peint noir/Painted black



PIED DE VERIN AUTOMATIQUE FLIP™ / FLIP™ AUTOMATIC JACK FOOT

Aucun tracas avec des blocs en bois. Aucun problème de rangement. Vérin non inclus.
 No hassle with wood blocks. Nothing extra for you to store. Jack not included.



FY88004500
 4". Pour vérin de 2 1/4".
 4". For 2 1/4" jack.

FY88006500
 6". Pour vérin de 2 1/4".
 6". For 2 1/4" jack.

FY88006525
 6". Pour vérin de 2".
 6". For 2" jack.



RAM

VÉRINS / JACKS

1,000 LB

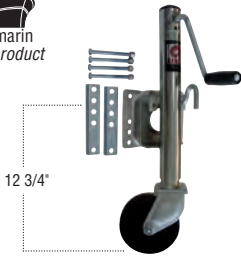

MJ-1001B

- Zinc
- Poignée sur le côté/Sidewind
- Élévation/Lift: 12.7" à/to 23 1/4"
- Course/Travel: 10 1/2"
- À boulonner/Bolt-on

1,500 LB

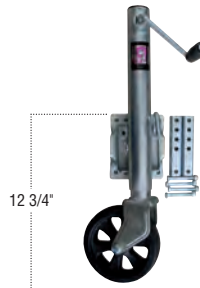

MJ-1500B

- Zinc
- Rotatif/Swivel
- Poignée sur le côté/Sidewind
- Roue/Wheel: 8"
- Fait jusqu'à/Fits up to: 3" x 5"
- Élévation/Lift: 12 3/4" à/to 22 3/4"
- Course/Travel: 10"
- À boulonner/Bolt-on

2,000 LB

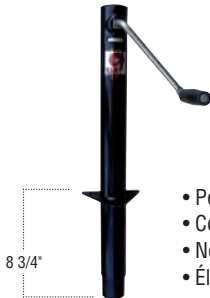

TJA-2000S

- Poignée sur le côté/Sidewind
- Course/Travel: 14 1/2"
- Noir/Black
- Élévation/Lift: 8 3/4" à/to 22 3/4"



TJP-2001-B

- Poignée sur le dessus/Topwind
- Course/Travel: 10"
- Fini noir/Black finish
- Élévation/Lift: 15 1/4" à/to 25 1/4"

3,500 LB

12 VOLTS

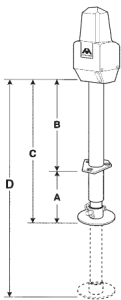

VERINS ÉLECTRIQUE À DEL LED ELECTRIC JACKS

EJ-3501-B

- Course/Travel: 18"
- Fini noir/Black finish
- En vrac/Bulk
- A: 8 1/2". B: 15". C: 23 3/4". D: 41 3/4"

5,000 LB



TJP-5001-B

- Poignée sur le dessus/Topwind
- Fini noir/Black finish
- Course/Travel: 10"
- Élévation/Lift: 10 3/4" à/to 20 3/4"

5,000 LB



TJP-5002-B

- Poignée sur le dessus/Topwind
- Fini noir/Black finish
- Course/Travel: 15"
- Élévation/Lift: 16" à/to 31"



TJA-5000-BP

- Poignée sur le dessus/Topwind
- Noir/Black
- Course/Travel: 14"
- Élévation/Lift: 10 1/2" à/to 24 1/2"

7,000 LB



TJD-7000

- Poignée sur le dessus/Topwind
- Course/Travel: 15"
- Pied extensible/Drop leg
- Fini peint noir/Black finish
- Pied de 6" x 8" inclus
6" x 8" foot included
- Élévation/Lift: 24" à/to 39"

ROUE / WHEEL



JC-101

Capacité/Capacity: 1,200 lb
Roue Poly Caster/Poly Caster wheel
Dimension: 2" x 6"
Fait sur tube de 2"/Fits on 2" tube
Pour/For: 2,000 & 5,000 lb

PIEDS DE VÉRIN / FOOTPLATES



JF-100-Z

Capacité/Capacity: 2,000 lb
Tube de 2 1/2" tube
Zinc • 1.7"H



JF-101BK

Capacité/Capacity: 2,000 lb
Tube de 2 1/2" tube
Zinc • 8.5"H

RAM

VÉRINS / JACKS

7,000 LB



TJD-7000S

- Poignée sur le côté/Sidewind
- Course/Travel: 15"
- Pied extensible/Drop leg
- Fini peint noir/Black finish
- Pied de 6" x 8" inclus / 6" x 8" foot included
- Élévation/Lift: 22 1/2" à 37 1/2"

22 1/2"

12,000 LB



TJD-12000SP-F

- Course/Travel: 12 1/2"
- Élévation/Lift: 27 1/2" à 40"
- Poignée sur le côté/Sidewind
- Pied de 6" x 8" inclus/6" x 8" foot included
- Goupille rétractable devant/Front pull pin
- Fini peint noir/Black finish
- Patte rétractable à ressort/Drop Leg spring return

27 1/2"

50,000 LB

Vendu à la paire
Sold in pairs



TJD2SPSET-50000

- Poignée sur le côté/Sidewind
- Course/Travel: 12 1/2"
- Élévation/Lift: 28 1/2" à 41"
- Poignée sur le côté/Pin to the side
- 2 & 1 vitesse/Speed
- 1 poignée/handle
- Quincaillerie d'installation incluse
Mounting hardware & clip included

27 1/2"

LGXTB

Barre de traverse
vendu séparément
Connecting shaft
Sold separately



VÉRINS / JACKS



182700

25,000 lb.
Poignée sur le côté / Sidewind
Course/travel : 12 1/2"
Pied extensible : 13 1/2"
Drop leg extension : 13 1/2"

182701

25,000 lb.
Poignée sur le côté / Sidewind
Course/travel : 12 1/2"
Pied extensible : 13 1/2"
Drop leg extension : 13 1/2"
avec ressort de rappel
With spring return



155157

2,000 lb
Fini à l'apprêt
8.6" à 21.5" d'élévation
2,000 lbs.
Primer finish
8.6" to 21.5" of lift



158109

2,000 lb. Fini à l'apprêt.
Support 2" dia.
Cheville 9/16".
10.8" à 20.8" d'élévation
2,000 lbs.
Primer finish.
2" dia. mount. 9/16"
pin. 10.8" to 20.8" of lift



151401

2,000 lb.
11" à 21" d'élévation
Poignée sur le dessus
11" to 21" of lift
Top handle



178151

5,000 lb.
Fini à l'apprêt. Support 2" dia.
Cheville 9/16".
14.7" à 29.7" d'élévation
5,000 lbs.
Primer finish. 2" dia. mount.
9/16" pin. 14.7" to 29.7" of lift



155022

2,000 lb
Fini à l'apprêt
8.2" à 23.2" d'élévation
2,000 lbs. Primer finish
8.2" to 23.2" of lift

155032

5,000 lb
Fini à l'apprêt
10.3" à 25.3" d'élévation
5,000 lbs. Primer finish
10.3" to 25.3" of lift

**PROTECTEURS DE ROULEMENT
AVEC CAPUCHONS
BEARING PROTECTORS
WITH COVERS**



Vendu à la paire
Sold in pairs

BPC1980604
1.980"

**PROTECTEURS DE
ROULEMENT
BEARING
PROTECTORS**



Vendu à la paire
Sold in pairs

BP244S0604
2.441"

**PROTECTEURS DE
ROULEMENT GRAISSABLES
GREASABLE BEARING
PROTECTORS**



Vendu à la paire
Sold in pairs

BPC1780604
Avec capuchons protecteurs
With bearing protector covers
1.78 dia.

**CAPUCHONS POUR PROTECTEUR DE ROULEMENT
BEARING PROTECTOR COVERS**

Vendu à la paire / Sold in pairs



BB17810112
1.781" • Emballé / Packaged

BB19800112
1.980"
Emballé / Packaged

BB19800312
1.980"
En vrac / Bulk

ROULETTES / CASTERS



6"

CE5550301
1,200 lbs
Tube 2"



6"

FUL017125
Roue 6" de métal pour verin (tube 2")
Caster with 6" steel wheel (tube 2")
1,000 lbs



6"

FUL6811S00
6" dia.
Roue de verin,
boulon et coussinet
de remplacement
Replacement wheel, bolt and
bushing

**PLAQUE DE SUPPORT À VERIN
A-FRAME SUPPORT PLATE**



FUL0031350300
2000 à / to 5000 lbs

**ENGRENAGE VERIN PRISE
LATÉRALE
SIDEWIND GEAR**



FUL500156
7000 lbs

FUL500106
5000 lbs. et plus
5000 lbs & up

PIEDS DE VERIN / FOOTPLATES



AW80238
2 1/2" H
Pied de verin pour / Foot pad for: AW80236

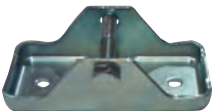

FP20000201
2,000 lbs • 2.25" x 4.5"



1400700340
Capacité / Capacity :
2000 à / to 5000 lbs
2" intérieur / interior

**PIED DE VERIN LONG
LONG FOOTPLATE**



FULF20000301
Capacité / Capacity:
2000 lbs.
2" intérieur / interior

**GOUPILLE 9/16" POUR VERIN
PULL PIN ASSEMBLY 9/16"**

FUL701472
7,000 - 8,000 lbs



**PIVOT DE MONTAGE VERIN ROND
TRAILER MOUNT MALE**



FUL500239
Pivot de montage verin rond 5,000 lbs
pour verin avec cheville 9/16"
Trailer mount male 5,000 lbs for
Topwind with 9/16" pin

**PROTECTEUR UNIVERSEL POUR BOULE D'ATTELAGE
UNIVERSAL TRAILER BALL COVER**

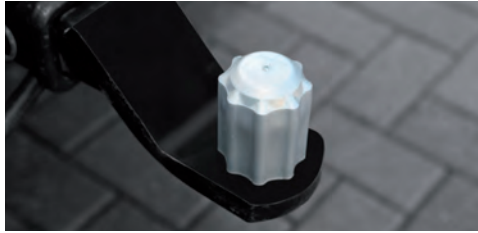

PF978

Convient pour boules / Fits balls:
1 7/8" - 2 5/16"

**PROTECTEUR UNIVERSEL POUR COUVERT
D'OUVERTURE D'ATTELAGE
UNIVERSAL TRAILER HITCH COVER**



AGRÉMENTEZ VOTRE PROTECTEUR DE COUVERT AVEC NOTRE
SÉLECTION D'ÉMBLÈMES PLAQUÉS CHROME.
ACCESSORIZE YOUR TRAILER HITCH COVER WITH OUR
SELECTION OF CHROME PLATED EMBLEMS.



Emblème non inclus - voir ci-bas
Emblem not included - see below

PF979
Pour attelages :
1 1/4" & 2"
For 1 1/4" & 2"
hitches

ÉMBLÈMES CHROMÉES VENDU À LA PAIRE / CHROMED EMBLEMS SOLD IN PAIRS



PF3403
Turbo



PF3406
Fire fighter



PF3411
4x4



PF3413
Route 66

SUPERWINCH

MOYEURS MANUELS VENDU À LA PAIRE / MANUAL HUBS SOLD IN PAIRS



- A. Lorsqu'on remplace un 4 roues motrices (NP203 seulement) un ensemble de conversion est requis.
When replacing fulltime 4WD (NP203 only) requires conversion kit.
B. Non compatible avec les modèles équipés avec "Quadra-trac".
Not compatible with Quadra-trac equipped models.

CHEVROLET/GMC

76-91 Pick-up 1 ton **SW400439^A**

DODGE

90-93 Pick-up 3/4 ton **SW400439**

90-93 Pick-up 1 ton (Dana 60) **SW400439**

FORD

59-86 F150 1/2 ton **SW400518**

78-97 F250 Pick-up 3/4 ton (D-60) **SW400439^{A, B}**

76-97 F350 Pick-up 1 ton **SW400439^{A, B}**

99-04 F250/F350 Super Duty **SW400439^A**

90-97 Ranger **SW400565**



MOYEURS MANUELS VENDU À LA PAIRE / MANUAL HUBS SOLD IN PAIRS



CHEVROLET/GMC

69-91 Blazer, Jimmy & Suburban^{1,2} **9790**

69-87 Pick-up 1/2 ton^{1,2} **9790**

77-87 Pick-up 3/4 ton^{1,2} **9790**

DODGE

69-74 Pick-up 1/2 ton & Ramcharger **9790**

80-93 Pick-up 1/2 3/4 ton & Ramcharger **9790**

FORD

66-96 Bronco^{1,2,3} **9790**

FORD (Cont.)

59-96 F Pick-up 1/2 ton^{1,2,3} **9790**

59-75 F250 Pick-up 3/4 ton **9790**

77½-97 F Pick-up 3/4 ton Light Duty² **9790**

INTERNATIONAL HARVESTER

68-75 Pick-up 1/2 ton **9790**

JEEP

74-87 Cherokee, Wagoneer, J-10 Pick-up¹ **9790**

77-87 J-20 Pick-up **9790**

1. Les véhicules avec 4 roues motrices en prise permanente requièrent un ens. de conversion de la boîte de transfert. / Vehicles with full time 4WD will require a transfer case conversion kit.
2. Lorsqu'on remplace des moyeux automatiques à capuchon vissable à 3 trous pour des moyeux manuels, vous devez acheter l'ens. d'écrou de moyeu de conversion approprié.
When replacing automatic 3 hole cap screw hubs with manual hubs, you must purchase corresponding spindle nut conversion kit.
3. Ne fait pas sur les modèles 87 début 88 avec montage à rebord. / Will not fit 87-early 88 model vehicles, flange mount.

Les codes en ROUGE indiquent un item discontinué à quantité limitée / Codes in RED indicate a limited quantity discontinued item

FULTON

TREUILS MANUELS / MANUAL WINCHES

Bidirectionnel
Two way

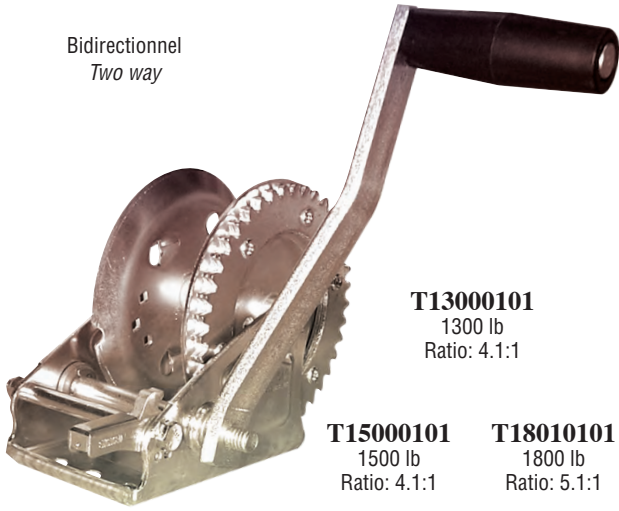

T13000101
1300 lb
Ratio: 4.1:1

T15000101
1500 lb
Ratio: 4.1:1

T18010101
1800 lb
Ratio: 5.1:1

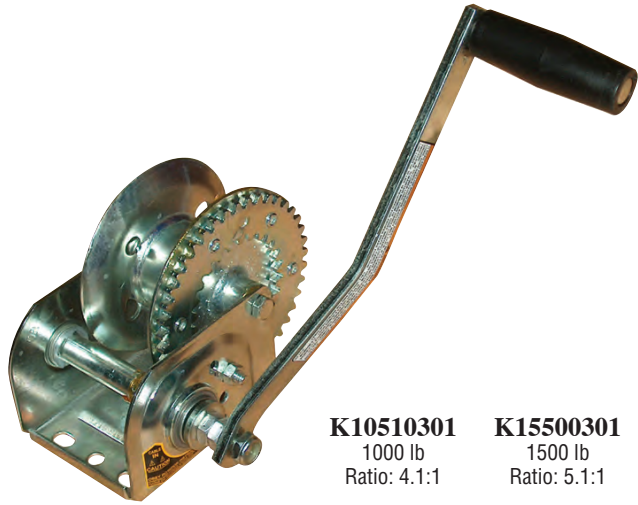

K10510301
1000 lb
Ratio: 4.1:1

K15500301
1500 lb
Ratio: 5.1:1

Bidirectionnel avec neutre
Two way with neutral

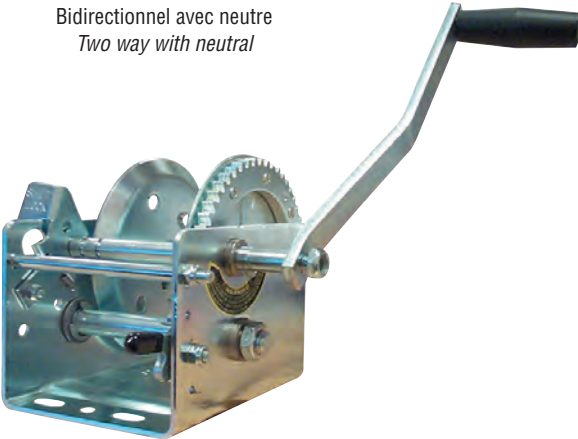

T20050101
2000 lb
Ratio: 4.1:1 & 9.8:1

T26050101
2600 lb
Ratio: 5.1:1 & 12.2:1

T32050101
3200 lb
Ratio: 5.1:1 & 12.2:1

T37000101
3700 lb
Ratio: 5.1:1 & 12.2:1
avec frein/with brake



K6500101
600 lb

TREUILS À FREIN BRAKE WINCHES

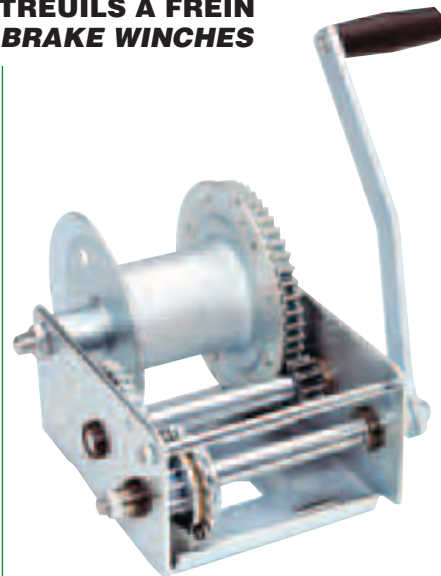

K25500301
2500 lb

COURROIES & CÂBLE AVEC CROCHET / STRAPS & CABLE WITH HOOK



Courroie / Strap
2" x 20' 2600 lb

WS200200
Vrac / Bulk

WS200700
Emballage de vente
Retail package



WC3250100
Câble / Cable
3/16" x 25'
4200 lb

POIGNÉES 8" 8" HANDLE



FUL6302P01
Pour / For T1300, T1500 & 1500Z

FULTON

TREUILS MANUELS À COURROIE / MANUAL WINCHES WITH STRAP



XLT26ZC301

2,600 lb • Ratio: 5.1:1 & 12.2:1.
Bidirectionnel avec neutre.
Courroie de 20' avec crochet.
Two way with neutral. 20' strap with hook.



T2605SC301

2,600 lb • Ratio: 5.1:1 & 12.2:1.
Bidirectionnel avec neutre.
Sans courroie
Two way with neutral. Without strap.



T2005SC301

2,000 lb • Ratio: 4.1:1 & 9.8:1.
Bidirectionnel avec neutre.
Sans courroie.
Two way with neutral. Without strap.



FW16000101

1600 lb • Ratio: 4.1:1
Revêtement résistant à la corrosion résiste
aux dommages de l'humidité et du sel.
Courroie de 20' avec crochet.
*Corrosion-resistant coating resists damage from
moisture and salt. 20' strap with hook.*
8"H x 6.5"W x 9.5"D



FULT1500Z0101 FULT1500Z0301

Boîte / Boxed Vrac / Bulk
1,500 lb • Ratio: 4.1:1.
Bidirectionnel.
Courroie de 20' avec crochet.
*Two way
20' strap with hook.*



FULT900Z0301

900 lb • Ratio: 3.1:1.
Unidirectionnel.
Courroie de 15' avec crochet.
*One way
15' strap with hook.*

TREUILS MANUELS / MANUAL WINCHES



T6000301

600 lb
Ratio: 3.1:1
Bidirectionnel / Two way

T9000301

900 lb
Ratio: 3.1:1
Bidirectionnel / Two way

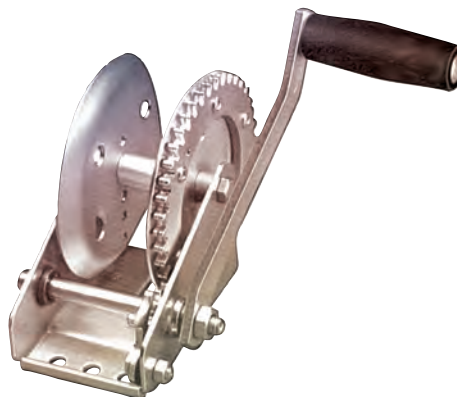

T11000101

1100 lb
Ratio: 4.1:1
Bidirectionnel / Two way

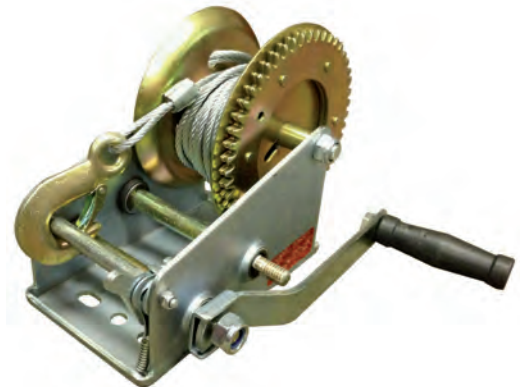

BUTBP-HW20-C

2,000 lb
Ratio: 4.1:1 & 9.8:1.
Bidirectionnel avec neutre. Câble d'acier avec crochet.
Two way with neutral. Steel cable with hook.

BUTBP-HW25-C

2,600 lb
Ratio: 5.1:1 & 12.2:1.
Bidirectionnel avec neutre. Câble d'acier avec crochet.
Two way with neutral. Steel cable with hook.

**ACCESSOIRES POUR SYSTÈME DE FREIN D'URGENCE
BREAK-AWAY ACCESSORIES**



HP20001
Système de frein d'urgence
avec chargeur et interrupteur
*Break-away kit
with charger & switch*

HP20002
Système de frein d'urgence
avec interrupteur
et ens. d'installation
*Break-away kit with switch
& hardware kit*

HP20100
Système de frein d'urgence
avec compteur de batterie
pour DEL, chargeur et boulons
*Break-away kit
with LED battery meter,
charger & screws*

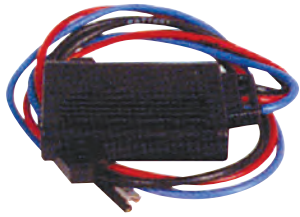

HP20011
Chargeur pour batterie
Battery charger

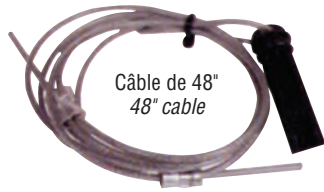

HP20012
Câble et goupille / *Cable & pin*



HP20008
Batterie rechargeable
Rechargeable battery
12V, 5A



D2024-07
Chargeur à batterie.
Pour batterie de démarrage.
Battery charger. For breakaway battery.

CONTRÔLEURS DE FREINS ÉLECTRONIQUES / ELECTRONIC BRAKE CONTROLS

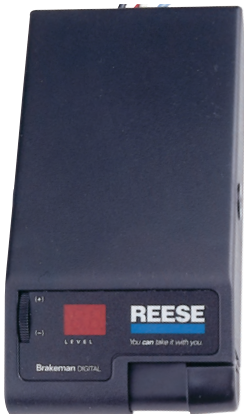

R83500
Pour remorques avec 2, 4, 6 ou 8
freins. Indicateur numérique.
Compatible avec freins ABS
*For trailers with 2, 4, 6 or 8
brakes. Digital indicator.
Compatible with ABS brakes.*



R83501
Pour remorques avec 2 ou 4 freins.
Indicateur avec lumière rouge.
Compatible avec freins ABS.
*For trailers with 2 or 4 brakes. Red
indicator light. Compatible with ABS
brakes.*



D5100
Pour remorques avec 2 ou 4 freins
For trailers with 2 or 4 brakes

D5500
Pour remorques avec 2, 4, 6 ou 8 freins
For trailers with 2, 4, 6 or 8 brakes



**BRANCHEZ ET UTILISEZ!
PLUG & PLAY!**

R83520
Pour remorques avec 2, 4, 6 ou 8 freins.
Indicateur numérique.
*For trailers with 2, 4, 6 or 8 brakes.
Digital indicator.*



D20505
Ens. de filage pour **D5100** :
25' de fil duplex 12-2,
coupe-circuit 20 amp.
et terminaux de connexion
*Wiring kit for D5100:
25' 12-2 duplex wire,
20 amp. circuit breaker
and attaching terminals*



PROTECTEUR / PROTECTOR

D11917
Avec circuit et protection de surcharge et connecteur 5
fils plats pour lumière de recul ou verrouillage de frein
*With integrated circuit & overload protection & 5-flat
connector for backup light or surge brake lockout*

CONTRÔLEURS DE FREINS ÉLECTRONIQUES / ELECTRONIC BRAKE CONTROLS

PRODIGY® P2



T90885

Pour remorque de 2 à 4 freins.
Ecran numérique.
For 2 to 4 axle trailers.
Digital display.



T90195

Pour remorque avec 2, 4, 6 ou 8 freins. Ajustement automatique du freinage. Amovible. Accentueur de frein. Ecran numérique.
For trailers with 2, 4, 6 or 8 brakes. Automatic adjustment level. Removable. Brake booster. Digital display.

PRIMUS IQ



T90160

Pour remorque avec 2, 4 & 6 freins.
Ecran numérique.
For trailers with 2, 4 & 6 brakes. Digital display.

PILOT



T80550

Pour remorque avec 2, 4, 6 ou 8 freins.
Ecran numérique.
For trailers with 2, 4, 6 or 8 brakes. Digital display.

VOYAGER XP



T9030

Pour remorque avec 2 ou 4 freins
For trailers with 2 or 4 brakes

P.O.D



T80500

Pour remorque avec 2 ou 4 freins
For trailers with 2 or 4 brakes

**SYSTÈME DE FREIN POUR
INSTALLATION SUR REMORQUE
TRAILER MOUNTED BRAKING SYSTEM**

PRODIGY RF



T90250

Le module est étanche à l'eau et inclut un connecteur 7-voies de 8' scellé. Plusieurs options de montage pour l'avant de la remorque. Le module est alimenté par un câble 7-voies. Inclut télécommande (T90251).

Trailer power module is watertight and includes a sealed 8' 7-way vehicle connector. Multiple mounting options on the tongue or front of the trailer. Module powered through 7-way cable from the tow vehicle. Includes hand held unit (T90251).

FASTWAY

**CÂBLES DE DÉCROCHAGE ZIP™
ZIP™ BREAKAWAY CABLES**

FY80012140

4'

FY80012160

6'



Se connecte facilement.
Connects easily.

CONTRÔLEURS DE FREINS ÉLECTRONIQUES / ELECTRONIC BRAKE CONTROLS

RAPTOR



Le plus petit sur le marché
Smallest on the market

VA32814

Autocalibrage. Aucun nivellement requis. Fonction gyroscopique avancée. Pour remorque de 2, 4 ou 6 freins. Support pour station d'accueil permet au contrôleur de frein d'être bougé de véhicule à véhicule sans déconnecter le harnais. Détection automatique de niveau et de "Azimuth". Le "Raptor" surveille continuellement le niveau du sol pour déterminer la puissance de freinage optimale sur n'importe quel terrain ou grade. Entièrement fonctionnel en marche arrière. Accepte les freins électriques par dessus les freins hydrauliques avec aucun ajustement additionnel requis.

Self calibrating. No leveling required. Advance gyroscopic functionality. Supports 2, 4 or 6 brake. Exclusive docking station mounting bracket allows the brake control to be moved from vehicle to vehicle without the need to disconnect the wiring harness. Automatic level and Azimuth detection. The Raptor continually monitors both ground level and travel to determine optimal braking power over any terrain or grade. Fully functional in reverse. Supports electric over hydraulic braking with no additional settings required.

3"W x 3 3/4"L x 1"H



PHANTOM

VA32811

Frein pour remorque fort et efficace. Capacité de réglage infini de la puissance et du temps de réaction. Technologie pour contrôleur de frein F.E.T. Pour remorque de 2 ou 4 freins. Aucun nivellement requis. **Compatible avec harnais à lien direct.**

Strong dependable time-based trailer braking. Infinite adjustability in both output and ramp time settings. F.E.T. brake control technologie. Supports 2

or 4 brake trailers. No leveling required. Compatible with Direct link harnesses.

3"W x 3 3/4"L x 1"H



BLACKBIRD

VA32812

Capable d'atteindre sa puissance maximale deux fois plus rapidement que des contrôles similaires. Pour remorque de 2, 4, 6 ou 8 freins. Aucun nivellement requis. **Compatible avec harnais à lien direct.**

Capable of reaching its maximum output power twice as fast as similar controls. Supports 2, 4, 6 or 8 brake trailers. No leveling required. Compatible with Direct link harnesses.

HARNAIS POUR CONTRÔLEUR DE FREIN À LIEN DIRECT DIRECT LINK WIRING HARNESSSES

BUICK		CHEVROLET / GMC (Cont.)		HUMMER	
08-13 Enclave	VA30545	00-02 Suburban/Tahoe/Yukon/Yukon XL	VA30532	07-10 H2 & H2 SUT	VA30543
CADILLAC		09-13 Traverse	VA30545	03-06 H2 & H2 SUT	VA30534
07-13 Escalade, ESV, EXT	VA30543	DODGE		05-10 H3	VA30543
03-06 Escalade, ESV, EXT	VA30534	07-08 Aspen w/factory tow pkg.	VA30530	JEEP	
02-13 Escalade EXT	VA30532	97-11 Dakota w/factory tow pkg.	VA30530	2001 Grand Cherokee	VA30530
00-02 Escalade	VA30532	98-11 Durango w/factory tow pkg.	VA30530	LINCOLN	
CHEVROLET / GMC		95-13 Ram 1500/2500/3500	VA30530	06-08 Mark LT	VA30525
08-13 Acadia	VA30545	FORD		98-11 Navigator	VA30525
07-13 Avalanche	VA30543	94-96 Bronco	VA30525	NISSAN	
03-06 Avalanche	VA30534	92-13 Econoline Van FS	VA30525	05-10 Frontier	VA30538
2002 Avalanche	VA30532	00-04 Excursion	VA30525	05-10 Pathfinder	VA30538
07-13 Denali (incl. XL)	VA30543	97-13 Expedition	VA30525	04-12 Pathfinder Armada	VA30538
03-06 Denali (incl. XL)	VA30534	02-13 Explorer w/ Factory tow pkg.	VA30525	04-13 Titan	VA30538
99-02 Denali (incl. XL)	VA30532	09-13 F150 Pick-up	VA30546	SATURN	
07-13 Silverado/Sierra All	VA30543	94-08 F150 Pick-up	VA30525	08-10 Outlook	VA30545
2007 Silverado/Sierra Classic only	VA30534	94-04 F250/F350 All	VA30525	TOYOTA	
03-06 Silverado / Sierra	VA30534	09-13 Flex w/ Factory tow pkg.	VA30525	03-13 4Runner	VA30527
99-02 Silverado / Sierra	VA30532	95-03 Windstar w/ Factory tow pkg.	VA30525	02-13 Sequoia	VA30527
07-13 Suburban/Tahoe/Yukon/Yukon XL	VA30543	HONDA		03-13 Tacoma	VA30527
03-06 Suburban/Tahoe/Yukon/Yukon XL	VA30534	06-13 Ridgeline	VA30539	03-13 Tundra	VA30527

HARNAIS POUR CONTRÔLEUR DE FREIN WIRING HARNESS (ODYSSEY)



VA30518
FORD
F250/F350 Pick-up 08-13

ENSEMBLE DE FILAGE UNIVERSEL POUR CONTRÔLEUR DE FREIN UNIVERSAL BRAKE CONTROL WIRING KIT



VA37194
Pour remorque à
2, 4, 6 ou 8 freins
For trailers with 2,
4, 6 or 8 brakes

ADAPTATEURS POUR CONTRÔLEUR DE FREINS / BRAKE CONTROL WIRING ADAPTERS



T20273

T3045-P

CHEVROLET / GMC

03-06	Avalanche	T3015
03-07	Silverado / Sierra Classic	T3015
99-02	Silverado / Sierra	T3025
03-06	Suburban	T3015
03-06	Tahoe	T3015
03-06	Yukon / Denali / XL / XL Denali	T3015

DODGE / RAM

97-11	Dakota w/ Factory tow package	T3020
11-13	Durango w/ Factory tow package	T3045
11-13	Durango w/ Factory tow package	T3045-P
98-09	Durango w/ Factory tow package	T3020
10-12	Ram (All) 1-plug	T20273
95-09	Ram	T3020

FORD

92-08	E- Vans	T3035
02-10	Explorer	T3035
97-12	Expedition	T3035
09-12	E150/250/350	T3034
94-04	F Series	T3035
11-13	F150 (All) 2-plug	T3036P
08-13	F250/350 SD	T3034
05-07	F Super Duty	T3065

HONDA

09-13	Pilot w/ Factory tow package	T3070
06-13	Ridgeline w/ Factory tow package	T3070

JEEP

11-13	Grand Cherokee w/ Factory tow package	T3045
11-13	Grand Cherokee w/ Factory tow package	T3045-P

NISSAN

04-12	Armada	T3050
05-12	Frontier	T3050
05-12	Pathfinder	T3050
04-12	Titan	T3050

TOYOTA

03-13	4 Runner	T3040
03-11	Land Cruiser	T3040
03-12	Sequoia	T3040
07-13	Tacoma	T3040
03-12	Tundra	T3040

P : Emballage-coque / Clamshell

SYSTÈME DE FREIN D'URGENCE AVEC FREINS ÉLECTRIQUES BREAKAWAY SYSTEM WITH ELECTRIC BRAKES



T1028

Incl. boîtier de batterie, batterie (12V, 4 amp/hr), chargeur, interrupteur.
Incl. battery case, battery (12V, 4 amp/hr), charger device, switch.

50-85-115
Support
seulement
Bracket only



T50-85-313

Incl. boîtier de batterie, batterie 5 ampères avec multimètre à test à DEL, chargeur à plusieurs phases intégré et commutateur. Support non inclus.
Incl. battery box, 5 amp battery w/ push to test LED test meter, integrated multi-stage charger and breakaway switch. Bracket not included.

SIMULATEUR DE REMORQUE TRAILER SIMULATOR



T6562
7 contacts
7-way



CONTRÔLEUR DE FREIN ÉLECTRONIQUE ELECTRONIC BRAKE CONTROL



PTC-301

Micro processeur de 24MHz. Temps de réponse de 0,03 secondes. Pourcentage préréglé affiché sur l'écran ACL. Assez puissant pour manoeuvrer jusqu'à 16 systèmes de frein sans devenir chaud.
24MHz micro processor. Response time of 0.03 seconds. Pre-set percentage shown on the LCD screen. Powerful enough to handle up to 16 braking systems without getting hot.



ADAPTATEURS POUR CONTRÔLEUR DE FREINS / BRAKE CONTROL WIRING ADAPTERS



D20263

CADILLAC

2002 Escalade incl. EXT

CHEVROLET / GMC

2002 Avalanche

99-02 Silverado / Sierra

00-02 Suburban / Tahoe
(w/ amber turn signal)

00-02 Yukon / XL

01-02 Yukon Denali (w/ amber turn signal)

01-02 Yukon XL Denali



D20264

CADILLAC

03-06 Escalade All incl. EXT & ESV

CHEVROLET / GMC

03-06 Avalanche

03-07 Silverado / Sierra Classic

03-06 Suburban / Tahoe

03-06 Yukon / XL & Denali

HUMMER

03-07 H2



D22284

CADILLAC

03-06 Escalade All incl. EXT & ESV

CHEVROLET / GMC

03-06 Avalanche

03-07 Silverado / Sierra Classic

03-06 Suburban / Tahoe

03-06 Yukon / XL & Denali

HUMMER

03-07 H2

05-07 H2 Sut.



D20261

CHRYSLER

07-09 Aspen w/ Factory tow pkg.

DODGE

97-11 Dakota w/ Factory tow pkg.

98-09 Durango w/ Factory tow pkg.

95-09 Ram All



D20267

FORD

05-07 F250/350 SD

05-07 F350/450/550 SD

Cab & Chassis



D20270

FORD

08-13 F250/350/450/550 SD



T3032

KIA

09-11 Borrego



T3021

DODGE / RAM

10-12 Ram

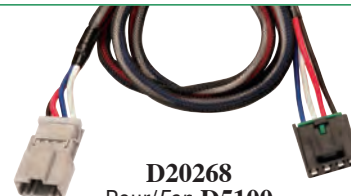

D20268
Pour/For: D5100

HONDA

06-12 Ridgeline w/ OEM tow pkg.

09-13 Pilot w/ OEM tow pkg.



**ADAPTATEUR "MULTI-TOW" (EOM)
MULTI-TOW ADAPTOR (OEM)**



HP40975
CHEVY/DODGE/FORD/GMC
Combo 7 brins rond /
4 bring plat
7-Way Round/
4-Way Flat combo

ADAPTATEUR / ADAPTOR



Avec/With
"Nite-glow"



HP47585

Adaptateur 7 fils plats à 6 fils ronds et 4 fils plats. Auxiliaire au centre.
7-way flat to 6-way round and 4 wire flat. Center pin auxiliary

ACCESSOIRES / ACCESSORIES

SUPPORT DE MONTAGE / MOUNTING BRACKET



D118144

SUPPORTS POUR CONNECTEUR 7 fils / 7-WAY CONNECTOR BRACKETS



D118138
Universel
Universal



D20212
Pour prise de type EOM
For OEM style plug



COUPE CIRCUIT / CIRCUIT BREAKER
AVEC SUPPORT DE MONTAGE
WITH MOUNTING BRACKET



D38620
In-line 20 Amp.
HH38630
30 Amp

MODULATEURS DE PUISSANCE POUR LUMIÈRES DE REMORQUE / TRAILER LIGHTS POWER MODULES

(Se branche directement à la batterie / Plugs directly to battery)



D119146
2.1 Amps : stop/turn circuit
& 5 Amps : tail circuit



D119190
4.2 Amps : stop/turn circuit
& 7.5 Amps : tail circuit

D119191
4.2 Amps : stop/turn circuit
& 7.5 Amps : tail circuit
Ens. de filage 20'
20'L wiring kit



D119176
2.1 Amps : stop/turn circuit
& 5.6 Amps : tail circuit

D119186
2.1 Amps : stop/turn circuit
& 5.6 Amps : tail circuit
Ens. de filage 20'
20'L wiring kit

CONVERTISSEURS DE FEUX ARRIÈRE / TAIL LAMP CONVERTORS



D119130
Convertit de 3 à 2 fils / Converts 3 to 2 wires

VÉRIFICATEUR DE CIRCUIT / CIRCUIT TESTER



D20114

BOÎTE DE MONTAGE POUR CONNECTEUR À 6 OU 7 FILS / 6 & 7-WIRE CONNECTOR MOUNTING BOX

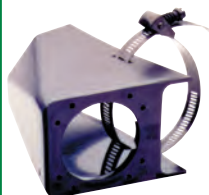

D118156
Tube carré de 2 1/2"
2 1/2" square tube

D118157
Tube carré de 3"
3" square tube

D118159
Universel
Tube carré ou rond.
Universal
Square or round tube.

CONVERTISSEUR / CONVERTOR

Avec protecteur de circuit intégré
With integrated circuit protector



D119175
Haut rendement
Heavy Duty

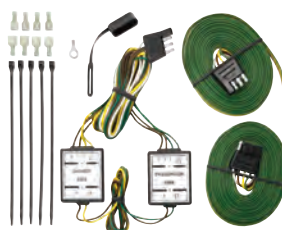

D118821
Système d'isolation pour feu arrière avec 4 plat.
Taillight isolating system with 4-flat

OUTILS POUR PASSER LES ATTACHES / WIRE LOOMS FOR FISHWIRING FASTENERS

Paquet de 20 / Pack of 20



D5481
7/16"

D5482
1/2"

PRISE UNIVERSELLE POUR CONTRÔLEUR DE FREIN / UNIVERSAL BRAKE CONTROL PLUG

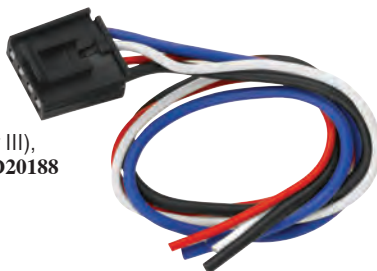

D20127
Pour/For: **D5520** (Activator III),
D20185 (Intella-Stop Ultra), **D20188**
(Intella Stop Digital)

ADAPTATEURS POUR CONTRÔLEUR DE FREINS / BRAKE CONTROL WIRING ADAPTERS



D20260
FORD Bronco FS 94-96,
E-150/E-250/E-350 Econoline Van FS All 92-08, E-350/E-450 Econoline Van RV cutaway w/Factory Tow Prep Plug 92-08,
Excursion All 00-05, Expedition All 97-11,
F150 94-08, F250 94-04.

D20261
CHRYSLER Aspen w/Factory Tow Package 07-09,
DODGE Dakota w/Factory Tow Package 97-11, Durango w/Factory Tow Package 98-09,
Ram FS 1500/2500/3500 only All 95-09.

COUVRES CONNECTEUR / CONNECTOR COVERS



D20112
À l'unité / Per unit

D20112-24
Paquet de 24
Pack of 24



D20118
À l'unité / Per unit

D20264
CADILLAC Escalade All (Incl: EXT & ESV) 03-06,
CHEVROLET / GMC Avalanche All 03-06, Silverado/Sierra 03-07,
Suburban All 03-06, Tahoe 03-06, Yukon All & Yukon Denali All 03-06,
Yukon XL All & Yukon XL Denali All 03-06,
HUMMER H2 All 03-07, H2 SUT All 05-07



CONNECTEUR DE REMPLACEMENT AVEC FILAGE / REPLACEMENT CONNECTOR WITH WIRING



D118267
NISSAN Pathfinder, XTerra 05-12
(with towing package)



D118266
NISSAN Pathfinder, XTerra 05-12 All



D118265
HONDA Pilot 12-13



**HARNAIS DE RECHANGE DE TYPE OEM AVEC "TOW PACKAGE"
REPLACEMENT OEM STYLE TOW PACKAGE WIRING HARNESS**



D118260
4 plat / 4-Flat
Ford E-150/E-250/E-350 Econoline Van,
Full Size, All models w/factory 4-flat
(prepped class I towing package) 09-13



D118261
7 contact / 7-way
Ford E-150/E-250/E-350 Econoline Van,
Full Size, All models w/factory 7-way
(prepped class II towing package) 09-13

**HARNAIS DE REMORQUAGE
DE TYPE OEM
OEM STYLE TOW WIRING HARNESS**



SB2912
JEEP JK 2/4 DR 07-13



**FILAGE PRIMAIRE
PRIMARY WIRE**

D38250
12 ga. x 2 • 500'
Noir et bleu / Black & blue



CONNECTEUR / WIRE TAP

HH38410-100
Calibre 16-18 gauge
Sac de 100 / Bag of 100



**SUPPORT POUR PRISE
PLUG HOLDER**



**6 & 7 CONTACTS
6 & 7-WAY**

54-98-003
Côté remorque seulement
Trailer end only

**SUPPORT POUR CONNECTEUR
MOUNTING BRACKET**

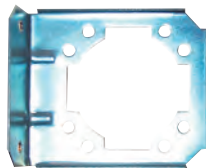

7 CONTACTS / 7-WAY

50-77-070
Côté auto
seulement (zinc)
Car end only (zinc)

50-77-071
Côté auto
seulement (noir)
Car end only (black)

**CONNECTEUR DE
REMORQUE
TRAILER CONNECTOR**



50-67-003
7 fils / 7-way: 8'

**CONNECTEURS / CONNECTORS
7 CONTACTS, MÉTAL / 7-WAY METAL**



50-57-503
Côté auto
seulement
Car end only

50-57-007
Côté remorque
seulement
Trailer end only



**CONNECTEUR PLAT 4 FILS
4-WIRE FLAT CONNECTOR
CÔTÉ REMORQUE / TRAILER SIDE**



J-5024WH
Wishbone
Remorque/Trailer: 25'





CONNECTEURS / CONNECTORS



D20320
Connecteur à 6 fils
6-way connector



D20111
7 fils EOM/7-way OEM
Pour/For: **DODGE**
Ram 1500 00-08 (w/factory 7-way)
Ram 2500/3500 00-09 (w/factory 7-way)



D118004
4 fils plat 12"
(remorque)
12" 4-way flat (trailer)

D20110
7 fils EOM pour:
7-way OEM for:

- CHEVY / GMC**
99-13 Silverado/Sierra w/Factory 7-Way
DODGE
09-12 Ram 1500 w/Factory 7-Way
10-12 Ram 2500/3500 w/Factory 7-Way
FORD
97-13 F150 w/Factory 7-Way
99-12 F Super Duty w/Factory 7-Way



LINCOLN
06-08 Mark LT w/Factory 7-Way
NISSAN
04-12 Titan w/Factory 7-Way
TOYOTA
10-12 Tundra w/Factory 7-Way

7 fils plat à combo 4 fils plat pour douille à 7 fils pour voiture américaine.
7-way flat pin to 4-flat combo adaptor harness for 7-way U.S. Car replacement socket



D20119
Pour/For: Dodge, Ford, GM,
Nissan & Toyota.



D20135
Pour/For: Chrysler, Dodge,
Freightliner, Jeep & Mitsubishi



D118044
4 fils plat 48"
(voiture & remorque)
48" 4-way flat
(car & trailer ends)

D118045
4 fils plat 60"
(voiture & remorque)
60" 4-way flat
(car & trailer ends)



D118017
5 fils plat (48" remorque)
5-way flat (48" trailer end)



D118016
5 fils plat 72" (voiture)
72" 5-way flat (car end)



D118043
4 fils plat avec boîtier (30"L)
4-way flat w/ housing (30"L)

HARNAIS POUR 5^E ROUE 5TH WHEEL HARNESS



D20140

- CHEVROLET / GMC**
07-13 Silverado / Sierra w/Factory 7-Way
99-07 Silverado / Sierra Classic w/Factory 7-Way
DODGE / RAM
09-12 Ram 1500 w/Factory 7-Way
10-12 Ram 2500 HD w/Factory 7-Way
10-12 Ram 3500 HD w/Factory 7-Way
FORD
04-13 F150, Flareside, Styleside
(New Body Style) w/Factory 7-Way
97-03 F150 Light Duty, Flareside, Styleside
w/Factory 7-Way
2004 F150 Light Duty Heritage,
(Old Body Style) w/Factory 7-Way

- FORD (cont.)**
04-12 F150 SuperCrew
New Body Style w/Factory 7-Way
97-99 F250 Light Duty, Styleside
w/Factory 7-Way
99-12 F250 Super Duty w/Factory 7-Way
99-12 F350/F450 Super Duty w/Factory 7-Way
99-11 F550 Super Duty w/Factory 7-Way
LINCOLN
06-08 Mark LT w/Factory 7-Way
NISSAN
04-12 Titan w/Factory 7-Way
TOYOTA
10-12 Tundra w/Factory 7-Way



D118001
4 fils plat 48" (voiture)
48" 4-way flat (car)

D118002
4 fils plat 60" (voiture)
60" 4-way flat (car)



HARNAIS POUR 5^E ROUE / 5TH WHEEL HARNESS 90° • 7 contact plat/7-Way Flat



51-97-410
54700-003

	CHEVROLET / GMC	VRAC/BULK (7')	EMBALLÉ/PACKAGED (9')
07-13	Silverado/Sierra	54700-003	51-97-410
99-07	Silverado/Sierra w/Factory 7-Way	54700-003	51-97-410
	DODGE / RAM		
09-12	Ram 1500 FS w/Factory 7-Way	54700-003	51-97-410
10-12	Ram 2500HD/3500HD w/Factory 7-Way	54700-003	51-97-410
00-08	Ram 1500 FS w/Factory 7-Way	---	51-97-411
00-09	Ram 2500HD/3500HD w/Factory 7-Way	---	51-97-411
	FORD		
04-13	F150 Flareside & Styleside (New body style) w/Factory 7-Way	54700-003	51-97-410
04-13	F150 SuperCrew, New body style w/Factory 7-Way	54700-003	51-97-410
2004	F150LD Heritage (Old body style) w/Factory 7-Way	54700-003	51-97-410
97-03	F150LD Flareside & Styleside w/Factory 7-Way	54700-003	51-97-410
97-99	F250LD Styleside w/Factory 7-Way	54700-003	51-97-410
99-12	F250/350/450/550SD w/Factory 7-Way	54700-003	51-97-410
	LINCOLN		
06-08	Mark LT w/Factory 7-Way	54700-003	51-97-410
	NISSAN		
04-12	Titan w/Factory 7-Way	54700-003	51-97-410
	TOYOTA		
10-12	Tundra w/Factory 7-Way	54700-003	51-97-410
07-09	Tundra w/Factory 7-Way	54700-004	51-97-412

EXTENSION POUR 5^E ROUE EXTENSION FOR 5TH WHEEL



50-61-104
Connecteur de remorque
Trailer connectors.
4'. 6 x 14ga.
6 fils/wires

ADAPTATEURS / ADAPTERS

MULTI-TOW

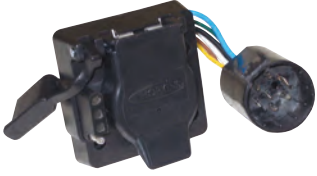

HP40955
Connecteur double/Double connector
Ford / GM / Nissan Multi tow • 7/4 contacts



HP47555
7 fils plat à 6 fils rond
7-way flat to 6-way round



HP47405
7 fils rond à 4 fils plat
7-way round to 4-way flat



HP47355
7 fils plat à 4 fils plats
7-way flat to 4-way flat



HP47305
6 fils rond à 4 fils plats
6-way round to 4-way flat

ENS. COMPLET DE RACCORDS DE REMORQUE / TRAILER CONNECTOR KIT POUR REMORQUE AVEC CONNECTEUR PLAT À 4 FILS / FOR TRAILERS WITH A FLAT 4-WAY CONNECTOR

HP41145
CVEVY/GMC

Silverado / Sierra
2500/3500 99-03
Silverado / Sierra 1500 99-02
Convertisseurs de feux arrière inclus
Tail converters included



Débranchez les fils sous le véhicule
Disconnect the wires under the vehicle



Rebranchez les fils au connecteur en "T"
Reconnect the wires to the "T" adaptor

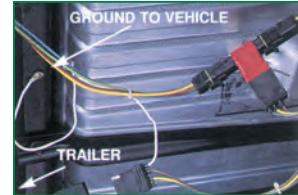

Faites la mise à terre
Ground to vehicle

CONNECTEURS DE REMORQUE / TRAILER CONNECTORS



HP20044
7 fils / 7-way : 6'



HP47105
Connecteur plat à 4 fils
4-wire flat connector



HP47185
Connecteur double
7 fils ou 4 fils.
Double connector
7-way or 4-way.

CONNECTEURS / CONNECTORS



HP47315
Adaptateur 6 fils à 4 fils plats (8")
6-way to 4-way flat adaptor (8")



HP47465
Adaptateur 4 fils à 4 fils plats (8")
4-way to 4-way flat adaptor (8")



HP47365
Adaptateur 7 fils à 4 fils plats (8")
7-way to 4-way flat adaptor (8")

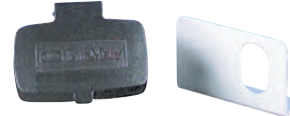

HP48755
Support & couvert pour 4 fils plats
4-wire flat mounting box and bracket

RACCORDS UNIVERSELS 11" DE REMORQUE 11" UNIVERSAL TRAILER CONNECTORS



CONVERTISSEUR INCORPORÉ WITH BUILT-IN CONVERTER

HP46155

Pour tout véhicule avec clignotant ambre ou avec ampoules séparées pour clignoteur et feux d'arrêt.
For all vehicle with amber turn signals or with separate bulbs for turn signals and brake lights.

MISE EN GARDE! / WARNING!
Consultez le manuel du véhicule
avant d'utiliser ce genre de convertisseur
Consult the vehicle's manual before
installing this type of converter

CONVERTISSEUR CONVERTOR



HP48915
Avec filage de 60"
With 60" wiring

PROTECTEUR MODULITE / MODULITE PROTECTOR



**"AUCUN FIL À COUPER"
"NO WIRES TO CUT"**

** Ne fait pas sur véhicule avec code électrique "N". Does not fit on vehicles with the electrical code "N".*

*** D119250**

ZCi Zéro contact interface Modulite universelle. 4.2 amps turn/stop. 7.5 Amps (taillight). Fonctionne sur la plupart des véhicules multiplex-pwm et "low side switch". Pas besoin de couper aucun fil.
ZCI™ Zero Contact Interface Universal T-Connector & Installation Kit. 4.2 amps turn/stop. 7.5 amps (taillight). Works on most Multiplex-pwm vehicles and low side switch. Doesn't require any wire cutting.

*** D119251**

ZCi Zéro contact interface Modulite universelle. 4.2 amps turn/stop. 7.5 Amps (taillight). Fonctionne sur la plupart des véhicules multiplex-pwm et "low side switch". Pas besoin de couper aucun fil. Inclus ensemble d'installation.
ZCI™ Zero Contact Interface Universal T-Connector & Installation Kit. 4.2 amps turn/stop. 7.5 amps (taillight). Works on most Multiplex-pwm vehicles and low side switch. Doesn't require any wire cutting. Installation kit included.



PROTECTEURS MODULITE / MODULITE PROTECTORS



D119176-012
Protecteur ModuLite avec circuit protecteur intégré. Paquet de 12. **Pour véhicule avec système "PWM"**
ModuLite Protector with integrated circuit protection. Pack of 12. For vehicle with "PWM" system



D119192
Protecteur **ModuLite "Ultra"**. Pour système PVM. Multiplex (Audi, BMW, Mercedes et VW). Ne fonctionne pas avec système "low-side switch". 4.2 Amps: stop/turn circuit & 16 Amps: taillight.
ModuLite Ultra protector. For PVM system. Multiplex (Audi, BMW, Mercedes and VW). Doesn't work with low-side switch system. 4.2 Amps: stop/turn circuit & 16 Amps: taillight.

**TUBE DE GRAISSE POUR CONTACT ÉLECTRIQUE
ELECTRICAL CONTACT GREASE TUBE**



HH11755
2 oz

CONNECTEUR / CONNECTOR



Bargman

54006-010
Pour remorque / For trailer
8' • 3 x 10 ga. - 4 x 14ga.



CONNECTEURS / CONNECTORS



50-86-004
Côté auto seulement. 6 contacts. Câble 4'. 6-14 ga.
Car end only. 6-way. 4' cable. 6-14 ga.



51-87-002
Côté auto seulement. 7 contacts avec câble 2'.
Car end only. 7-way super sealed car end with 2' cable.



PILOT™

CONNECTEURS & ADAPTATEURS / CONNECTORS & ADAPTORS



PTC-701

Connecteur de remorque avec adaptateur sonore
Trailer connector with beep adapter

- 7 fils contact plat à 5 filage plat / 7-way RV Blade to 5-wire flat
- Avec testeur incorporé / With built in tester
- Activer le mode d'essai sonore pour savoir si chacunes de vos fonctions sont opérationnelles... tout en étant assis dans votre véhicule.
Switch on test mode BEEPS to let you know if each of your trailer functions are operating... sitting inside your vehicle.



PTC-702

Connecteur de remorque avec adaptateur sonore
Trailer connector with beep adapter

- 7 fils contact plat à 6 rond / 7-way RV Blade to 6 round
- Avec testeur incorporé / With built in tester
- Activer le mode d'essai sonore pour savoir si chacunes de vos fonctions sont opérationnelles... tout en étant assis dans votre véhicule.
Switch on test mode BEEPS to let you know if each of your trailer functions are operating... sitting inside your vehicle.



CONNECTEURS & ADAPTATEURS / CONNECTORS & ADAPTORS



D118709

Adaptateur 7 fils ronds style VR à 4 fils plats
7-way round RV style to 4-way flat adapter



D118702

7 fils plats à 4 fils plats
7-way flat pin to 4-way flat



D118708

Adaptateur 7 fils à 6 fils.
Frein électrique à la prise externe (S).
7-way to 6-way adaptor.
Elec. brake to outer pin (S).



D118703

Adaptateur 7 fils à 5 fils
7-way to 5-way adapter



D118021

7 fils ronds en plastique (remorque)
7-way round plastic (trailer end)



D118704

7 fils plat à 6 fils rond, avec frein électrique à la prise externe (S) 6 fils.
7-way flat pin to 6-way round adapter, with electric brakes to outside (S) pin of 6-way



D118020

7 fils plat en plastique (voiture)
7-way flat plastic (car end)



D118036

6 fils rond en métal (voiture)
6-way round metal (car end)



D118015

7 fils ronds pour véhicules d'origine
7-way round for OEM vehicles
FORD, GMC & NISSAN



D20047

Connecteur de remplacement 7 fils pour véhicules GM d'origine
7-way car replacement socket for 7-way twist in OEM GM vehicles



D20141

Adaptateur 7 fils plats à 5 fils plat. Pour véhicule européen (Audi-Mercedes-VW) avec ensemble de remorquage OEM.
7-way flat to 5-way flat adaptor. For european vehicles (Audi-Mercedes-VW) with OEM tow kit.



BOÎTE DE RANGEMENT STORAGE BOX



D118145

Plastique. Pour filage/Plastic. For wiring



CÂBLE POUR REMORQUE AVEC CONNECTEUR SCELLÉ POUR VR TRAILER CABLE WITH SEALED RV CONNECTOR



W414312TA-7
4 x 14 ga. • 3 x 12ga.

W714TA-7
7 x 14 ga.

ADAPTATEUR RÉTRACTABLE RETRACTABLE WIRING ADAPTER

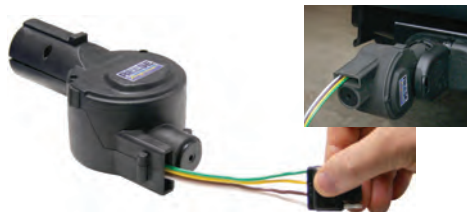

R78007

Connecteur plat. 7 contacts plat à 4 contacts plat. S'étend jusqu'à 42".
7-way flat blade to 4-way flat. Extends up to 42".

ADAPTATEURS DE PRISE À PRISE PLUG TO PLUG ADAPTERS



R78118

7 contacts plat à 4 ou 5 plat avec vérificateur de circuit à DEL
7-way blade to 4 or 5-flat with LED circuit tester



R78117

7 contacts plat à 4 plat avec lumière bleu. Couverture antipoussière inclus.
7-way flat to 4-flat with blue tow-glow. Dust cover included



CONNECTEURS POUR REMORQUE / TRAILER CONNECTORS



PTC-500

5 plat à 5 plat. Extension de 3'. Isolation résistante autour du fil.
5 flat to 5 flat. 3 feet extended. Heavy duty insulation around wire.



PTC-501

7 contacts rond à 4/5 plat. Extension de 3'. Isolation résistante autour du fil.
7-way round to 4/5 flat. 3 feet extended. Heavy duty insulation around wire.

ADAPTATEUR / ADAPTOR



787206

5 plat à 5 plat. Extension de 4'.
5 flat to 5 flat. 4 feet extended.



CONNECTEURS 4 FILS / 4 WIRE CONNECTORS

Répond aux normes les plus élevées de la SAE. Résistance accrue aux rayons UV, aux milieux salins et au feu. Offre une meilleure résistance à l'abrasion et reste plus souple qu'un câble standard lors d'écart de température importants. **Soudures scellées:** Joints fondants (thermorétractables) avec adhésif interne. Connecteurs scellés pour exemption totale de saleté et d'humidité.

Meets the highest TLV standards. For higher resistance to UV radiation, saline conditions and fire. Offers better abrasion resistance and stays more flexible than standard cable in wide temperature range situations. **Sealed welds:** Flux joints (heat-shrinkable) with internal adhesive. Sealed connectors for total dirt and moisture exclusion.



INNWX1283
CÔTÉ AUTO / CAR SIDE

Filage 4 conducteurs haut de gamme avec prise pour auto 48"
High quality wiring conductors (4) with plug for the car 48"



INNWX1267
CÔTÉ AUTO/REMORQUE / CAR/TRAILER SIDE

Filage 4 conducteurs haut de gamme avec prise pour auto et remorque 48"
High quality wiring conductors (4) with plug for car and trailer 48"(4) kit with plug for the trailer (up to 23')



INNWX1284
CÔTÉ REMORQUE / TRAILER SIDE

Ensemble complet de filage 4 conducteurs haut de gamme avec prise pour remorque (jusqu'à 23')
Complete high quality wiring conductors (4) kit with plug for the trailer (up to 23')



RACCORDS DE REMORQUE / TRAILER CONNECTORS

Prise à 4 fils de calibre 16. Solide construction monopièce. Apparence d'équipement d'origine.
16 gauge bonded wire w/4-flat plug. Solid one-piece construction. "Factory" appearance.

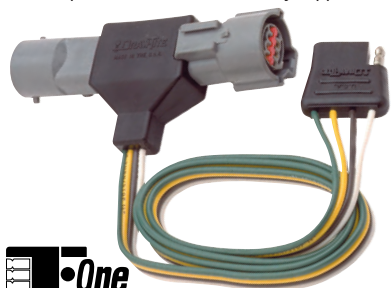

ACURA	
97-03 CL	D118336
94-01 Integra	D118336
07-13 MDX	D118424
01-06 MDX	D118336
2013 RDX	D118569
07-12 RDX	D118500
96-01 RL	D118336
09-12 TL	D118537
04-08 TL	D118489
96-03 TL	D118336
06-08 TSX	D118302
BUICK	
05-09 Allure	D118479
08-12 Enclave	D118450
08-12 Enclave (w/ 7-way)	D118384
10-13 La Crosse	D118497
06-11 Lucerne	D118419
11-13 Regal	D118504
02-07 Rendezvous	D118383
05-07 Terraza	D118396
12-13 Verano	D118564
CADILLAC	
08-13 CTS 4dr Sedan	D118466
04-07 CTS-V	D118440
03-07 CTS	D118440
02-11 Escalade (w/factory 7-way)	D118384
99-00 Escalade (Old body)	D118319
10-13 SRX (w/Factory Tow Package)	D118259
CHEVROLET	
02-11 Avalanche (w/factory 7-way)	D118384
04-11 Aveo 5 dr Hatchback	D118485
04-06 Aveo 4 dr Sedan	D118485
92-94 Blazer FS	D118319
85-91 Blazer FS	D118312
88-00 C/K Pick-up (Exc. 88-91 Crew cab)	D118315
85-87 C/K Pick-up	D118312
10-11 Camaro	D118486
05-11 Cobalt 2 dr	D118407
05-11 Cobalt 4 dr	D118398
04-12 Colorado	D118301
04-12 Colorado (w/ 7-way)	D118384
11-13 Cruze	D118508
10-13 Equinox	D118494
10-13 Equinox (w/Factory Tow Package)	D118264
07-09 Equinox	D118432
05-06 Equinox	D118391
03-13 Express Van	D118392
00-02 Express Van	D118377
96-99 Express Van	D118335
06-11 HHR	D118407
06-12 Impala	D118417
00-05 Impala	D118512
2012 Orlando	D118565
08-12 Malibu All (exc. LTZ)	D118450
98-04 S10 Pick-up	D118359
85-97 S10 Pick-up	D118312
99-13 Silverado (w/ 7-way)	D118384
12-13 Sonic 4dr Sedan/5dr hatchback	D118555

CHEVROLET (Cont.)	
00-11 Suburban (w/amber turn signal)	D118384
92-99 Suburban (Old body)	D118319
85-91 Suburban	D118312
00-11 Tahoe	D118384
95-00 Tahoe (Old body)	D118319
98-04 Tracker	D118372
09-12 Traverse	D118450
05-09 Uplander	D118396
97-05 Venture	D118355
CHRYSLER	
2011 200 4 dr Sedan	D118550
2011 200 Convertible, All	D118550
11-13 300 All	D118544
08-10 300	D118406
05-07 300 (Exc. 300C)	D118404
11-13 300C All	D118544
05-10 300C	D118406
99-04 300M	D118364
07-09 Aspen	D118390
98-02 Concorde	D118364
98-04 Intrepid	D118364
1999 LHS	D118364
04-08 Pacifica	D118303
01-10 PT Cruiser All	D118462
05-10 PT Cruiser Convertible All	D118462
07-10 Sebring & Sebring Convertible	D118444
11-13 Town & Country All	D118534
08-10 Town & Country All	D118552
04-07 Town & Country	D118300
01-03 Town & Country	D118376
96-00 Town & Country	D118334
91-95 Town & Country	D118323
01-03 Voyager	D118376
DODGE / RAM	
2011 Avenger All	D118550
08-10 Avenger	D118445
08-12 Caliber All	D118552
2007 Caliber	D118428
04-07 Caravan	D118300
01-03 Caravan	D118376
96-00 Caravan	D118334
91-95 Caravan	D118323
08-12 Challenger	D118404
11-13 Charger	D118560
06-10 Charger	D118404
03-11 Dakota	D118323
00-09 Dakota (w/ 7-way)	D118381
95-03 Dakota	D118329
87-94 Dakota	D118317
2013 Dart	D118568
11-12 Durango All	D118552
2009 Durango (w/ 7-way)	D118384
04-09 Durango	D118390
98-03 Durango	D118334
11-13 Grand Caravan All	D118534
08-10 Grand Caravan All	D118552
04-07 Grand Caravan	D118300
01-03 Grand Caravan	D118376
96-00 Grand Caravan	D118334
91-95 Grand Caravan	D118323
11-13 Journey w/LED taillights	D118536
2010 Journey	D118495
2009 Journey	D118474
05-08 Magnum	D118402
07-11 Nitro All	D118554
2007 Nitro	D118421
86-94 Pick-up D/W Series	D118317
10-12 Ram (w/ 7-way)	D118384
95-01 Ram Full size	D118329
2002 Ram FS 2500/3500	D118329
00-09 Ram (w/ 7-way) (not 1500 2009)	D118381
86-93 Ram Charger	D118317
03-09 Sprinter (w/ 7-way)	D118381
01-03 Van, Ram FS	D118381
FIAT	
2012 500 All, Incl. 500c (Cabrio)	D118546

FORD	
08-13 E-150/E-250/E-350 Econoline FS All	D118551
95-03 Econoline	D118344
92-94 Econoline FS	D118343
11-13 Edge (Incl. Sport models)	D118515
07-10 Edge All (Incl. Sport models)	D118551
2013 Escape	D118566
08-12 Escape All (Inc. Hybrid & vehicles w/backup sensors)	D118551
05-07 Escape	D118426
00-03 Escape	D118343
97-99 Escort 4 dr Sedan	D118344
98-03 Escort ZX2	D118344
97-03 Expedition	D118344
11-13 Explorer Upgraded	D118527
11-13 Explorer All	D118540
02-03 Explorer 4 dr	D118344
01-03 Explorer 2 dr Sport	D118344
2001 Explorer 4 dr	D118345
95-00 Explorer	D118345
2004 F150 Heritage Flareside (Old body)	D118344
00-03 F150 Super Crew	D118344
97-03 F150 Flareside	D118344
1997 F250 & F350 HD	D118316
87-96 F Pickup	D118316
11-13 Fiesta SD Hatchback	D118471
11-13 Fiesta 4dr	D118422
05-07 Five Hundred	D118395
09-13 Flex incl. Eco boost	D118472
12-13 Focus 5 dr Hatchback (Exc. ST model w/Center exhaust)	D118549
12-13 Focus Sedan only	D118548
08-11 Focus	D118457
00-03 Focus wagon (before 11/02)	D118344
04-07 Freestar	D118385
05-07 Freestyle	D118395
06-12 Fusion	D118422
92-97 LTD Crown Victoria	D118326
10-12 Mustang	D118487
94-04 Mustang (Exc. Cobra SVT)	D118326
00-03 Ranger	D118344
93-99 Ranger	D118325
10-12 Taurus (Sedan) incl. SHO	D118493
08-09 Taurus X	D118448
00-03 Taurus (Sedan)	D118375
96-99 Taurus (Sedan)	D118333
10-13 Transit Connect	D118254
2003 Windstar (After 11/03)	D118305
99-03 Windstar (Before 11/02)	D118366
95-98 Windstar	D118346
GMC	
07-12 Acadia (w/ 7-way)	D118384
07-12 Acadia	D118451
04-12 Canyon	D118301
04-12 Canyon (w/ 7-way)	D118384
85-91 Jimmy FS	D118312
88-00 C/K Pick-up (Exc. 88-91 Crew Cab)	D118315
88-91 C/K Pick-up Crew cab (Old body)	D118312
85-87 C/K Pick-up Series	D118312
99-13 Sierra New Gen (w/factory 7-way)	D118384
98-04 S15 / Sonoma	D118359
85-97 S15 / Sonoma	D118312
03-13 Savana	D118392
00-02 Savana	D118377
96-99 Savana	D118335
92-99 Suburban	D118319
85-91 Suburban	D118312
10-12 Terrain	D118494
10-12 Terrain (w/Factory Tow Package)	D118264
00-11 Yukon (New body)	D118384
92-00 Yukon (Old body)	D118319
HONDA	
08-12 Accord 4 dr	D118420
03-07 Accord 4 dr	D118302
08-12 Accord 2 dr	D118420
03-05 Accord 2 dr	D118441
10-12 Accord Crosstour	D118500

Les codes en ROUGE indiquent un item discontinué à quantité limitée / Codes in RED indicate a limited quantity discontinued item



RACCORDS DE REMORQUE / TRAILER CONNECTORS

HONDA (Cont.)		LEXUS		PONTIAC (Cont.)	
94-02 Accord sedan	D118336	07-11 ES 350	D118488	99-05 Montana	D118355
06-12 Civic 4 dr (Exc. Hybrid & Si)	D118420	04-06 RX 330	D118478	05-09 Pursuit/G5/GT 2 dr	D118407
06-12 Civic 2 dr except Si	D118437	07-12 RX 350	D118478	05-09 Pursuit/G5/GT 4 dr	D118398
12-13 CR-V	D118561	LINCOLN		07-09 Torrent	D118432
07-11 CR-V	D118427	03-04 Aviator	D118344	2006 Torrent	D118391
97-06 CR-V	D118336	09-12 MKS	D118471	97-98 Trans Sport (Incl. Montana)	D118355
07-11 Element	D118465	10-13 MKT	D118507	09-10 Vibe	D118460
03-04 Element	D118336	10-11 MKZ	D118543	03-08 Vibe	D118458
07-13 Fit	D118420	07-09 MKZ	D118502	SATURN	
11-13 Odyssey	D118521	11-13 MKX	D118519	07-09 Aura	D118423
05-10 Odyssey	D118438	07-10 MKX All	D118551	07-09 Outlook	D118434
95-04 Odyssey	D118336	98-03 Navigator	D118344	05-07 Relay	D118396
12-13 Pilot	D118558	2006 Zephyr	D118502	08-09 Vue All	D118443
09-11 Pilot	D118491	MAZDA		02-07 Vue	D118418
03-08 Pilot	D118336	11-13 2 All	D118520	SCION	
01-02 Prelude	D118336	04-13 3 All (exc. models w/ Grand Touring LED taillights package)	D118420	11-12 xB	D118460
06-13 Ridgeline	D118400	2012 5 All	D118520	SUBARU	
HUMMER		06-10 5 All	D118520	06-12 B9 Tribeca	D118461
06-10 H3 w/factory 7-way	D118384	09-13 6 4 dr Sedan	D118483	09-13 Forester	D118467
HYUNDAI		03-08 6 4 dr Sedan	D118405	98-08 Forester	D118461
2012 Accent 4 dr Sedan	D118559	04-08 6 5 dr Hatchback	D118405	08-11 Impreza 4 dr Sedan (incl. WRX)	D118464
06-11 Azera	D118413	07-12 CX-7	D118405	10-13 Legacy, Sedan	D118511
09-12 Elantra Touring HB 5 dr	D118473	07-12 CX-9	D118520	10-13 Outback Wagon (Exc. Sport)	D118467
11-13 Elantra 4 dr Sedan	D118532	94-08 Pick-up B-Series	D118325	00-09 Outback Wagon (Exc. Sport)	D118461
07-10 Elantra 4 dr	D118433	08-11 Tribute All (incl. Hybrid & vehicles w/ backup sensors)	D118551	SUZUKI	
07-09 Entourage	D118410	05-06 Tribute	D118426	09-12 Equator (w/factory Tow Package)	D118263
2013 Santa Fe	D118571	01-03 Tribute	D118343	09-12 Equator	D118525
07-12 Santa Fe	D118415	MERCURY		06-12 Grand Vitara All	D118456
01-06 Santa Fe	D118473	92-97 Grand Marquis	D118326	99-05 Grand Vitara	D118372
11-13 Sonata	D118557	96-99 Sable Sedan	D118333	07-11 SX4 Crossover	D118456
06-09 Sonata	D118433	97-99 Tracer 4 dr Sedan	D118344	08-11 SX4 Sport Sedan	D118475
10-13 Tucson	D118501	MITSUBISHI		99-05 Vitara	D118372
05-09 Tucson	D118397	04-11 Endeavor (09 does not exist)	D118516	07-09 XL-7 (w/factory Tow pkg.)	D118432
07-12 Veracruz All	D118529	07-12 Galant	D118420	01-06 XL-7	D118372
INFINITI		11-13 Outlander Sport All	D118538	TOYOTA	
07-08 G35 Sedan 4 dr	D118480	07-11 Outlander	D118518	10-11 4Runner (w/ 7-way)	D118384
09-13 G37 Sedan 4 dr	D118480	06-09 Raider	D118323	96-02 4Runner	D118341
97-03 QX4	D118361	11-12 RVR (Canada Only)	D118538	11-12 Avalon	D118482
04-11 QX56	D118384	NISSAN		2012 Camry 4 dr (Exc. Hybrid)	D118405
JEEP		08-13 Altima 2 dr	D118470	10-11 Camry 4 dr (Exc. Hybrid)	D118482
06-10 Commander (w/ 7-way)	D118381	07-12 Altima 4 dr Sedan	D118470	07-11 Camry 4 dr Hybrid	D118482
06-10 Commander	D118408	98-01 Altima	D118361	07-09 Camry 4 dr (Exc. Hybrid)	D118405
11-12 Compass	D118539	04-12 Armada w/factory 7-way	D118384	02-06 Camry 4 dr	D118308
07-10 Compass	D118428	09-12 Cube	D118492	97-01 Camry 4 dr	D118358
97-01 Cherokee	D118354	05-12 Frontier	D118525	09-13 Corolla	D118459
11-12 Grand Cherokee (w/ 7-way)	D118384	05-12 Frontier Pick-up (w/factory Tow Package)	D118263	00-02 Echo	D118386
00-10 Grand Cherokee 7-way	D118381	98-04 Frontier Pick-up	D118362	07-13 FJ Cruiser	D118405
07-13 Grand Cherokee	D118425	11-13 Juke All	D118528	08-13 Highlander All (incl. Hybrid)	D118449
05-06 Grand Cherokee	D118394	04-13 Maxima	D118470	04-07 Highlander All (incl. Hybrid)	D118248
99-04 Grand Cherokee	D118369	09-12 Murano	D118481	01-07 Highlander (Exc. Hybrid)	D118413
94-98 Grand Cherokee	D118349	05-12 Pathfinder	D118525	09-13 Matrix	D118460
09-12 Liberty (w/ 7-way)	D118384	05-12 Pathfinder All	D118263	03-08 Matrix	D118386
08-12 Liberty All	D118554	96-04 Pathfinder	D118361	89-95 Pick-up (Exc. T-100)	D118379
05-08 Liberty (w/ 7-way)	D118361	11-12 Quest Mini Van, All	D118547	04-11 Prius All	D118505
02-07 Liberty	D118524	04-09 Quest Mini Van	D118469	06-12 RAV 4	D118412
08-13 Patriot All	D118552	08-13 Rogue	D118480	01-05 RAV 4	D118389
2007 Patriot	D118428	07-12 Sentra	D118470	11-13 Sienna Van	D118498
98-06 TJ	D118409	04-12 Titan 7-way OEM	D118384	04-10 Sienna	D118304
07-13 Wrangler	D118416	07-12 Versa Hatchback	D118545	93-98 T-100 Pick-up	D118496
98-06 Wrangler	D118409	05-12 Xterra	D118525	09-12 Tacoma (w/ 7-way)	D118384
KIA		05-12 Xterra (w/factory Tow Package)	D118263	05-13 Tacoma Pick-up	D118496
09-11 Borrego	D118384	2012 NV1500/2500HD/3500HD	D118553	95-04 Tacoma	D118379
10-13 Forte 4 dr Sedan	D118415	OLDSMOBILE		10-12 Tundra w/factory 7 way	D118384
09-10 Optima All	D118433	97-04 Silhouette	D118355	01-02 Tundra	D118378
12-13 Rio 4/5 dr	D118570	PLYMOUTH		09-13 Venza	D118482
07-11 Rondo	D118431	96-00 Grand Voyager	D118334	07-12 Yaris Sedan	D118517
06-12 Sedona	D118410	91-95 Grand Voyager	D118323	VOLKSWAGEN	
02-05 Sedona	D118309	96-00 Voyager	D118334	05-10 Jetta 4 dr Sedan (New Body Style)	D118531
11-12 Sorento (Exc. SX V6)	D118506	91-95 Voyager	D118323	06-10 Passat 4 dr Sedan	D118562
07-09 Sorento (w/factory Tow Package)	D118529	96-00 Voyager	D118334	09-12 Routan All	D118490
03-06 Sorento	D118307	91-95 Voyager	D118323	VOLVO	
2011 Sorento EX V6 (w/o Factory Tow Package)	D118541	PONTIAC		08-10 V70 Wagon All (Incl. AWD)	D118463
2011 Sorento SX V6	D118541	01-05 Aztek	D118383	10-13 XC60 All	D118523
11-13 Sportage All	D118526	2009 G3 5 dr	D118485	08-10 XC70 Wagon AWD	D118463
05-10 Sportage 6 cyl.	D118401	05-09 G6 All	D118439	05-12 XC90 Wagon AWD	D118411
10-12 Soul	D118431	05-09 Montana SV6	D118396		

Les codes en ROUGE indiquent un item discontinu e   quantit e limit e / Codes in RED indicate a limited quantity discontinued item

CONNECTEURS / CONNECTORS

Véhicule / Car end

Remorque / Trailer end

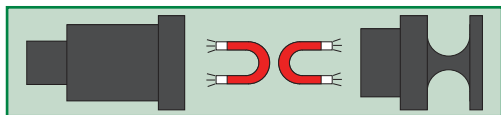

Véhicule
Car end



Remorque
Trailer end

- Contacts face-à-face chargés par ressort
- Joint torique d'étanchéité - Aucune corrosion
- Retenu fermement ensemble magnétiquement

- Spring-loaded, face-to-face contacts
- Waterproof, O-Ring-Sealed - No Corrosion
- Magnetically held tightly together

CONNECTEURS IMPERMÉABLES POUR VERSION DE PARE-CHOC EZR7 / EZR7 BUMPER VERSION WATERPROOF CONNECTORS



Ens. complets avec connecteur côté remorque de 4' / Complete Kits w/ 4' Trailer end

Hardwired 2'	Truck	EZR7-01
T-Connectors w/2'	GM, Ford, New Dodge & Toyota, Nissan	EZR7-02
T-Connectors w/2'	Old Dodge	EZR7-02D

Côté véhicule seulement / Vehicle side only

Hardwired 2'	Truck	EZR7-05
T-Connectors w/2'	GM, Ford, New Dodge & Toyota, Nissan	EZR7-06
T-Connectors w/2'	Old Dodge	EZR7-06D

Côté remorque seulement / Trailer side only

4' Remorque avec support pour prise / 4' Trailer w/ plug holder		EZR7-07
---	--	----------------

CONNECTEURS IMPERMÉABLES POUR VERSION DE PARE-CHOC EZS7 / EZS7 BUMPER VERSION WATERPROOF CONNECTORS



Ens. complets avec connecteur côté remorque de 4' / Complete Kits w/ 4' Trailer end

Hardwired 4'	Truck	EZS7-05/EZS7-07
Plug n Play	GM, Ford, New Dodge & Toyota, Nissan	EZS7-06/EZS7-07
Plug n Play	Old Dodge	EZS7-06D/EZS7-07

Côté véhicule seulement / Vehicle side only

Hardwired 4'	Truck	EZS7-05
Plug n Play	GM, Ford, New Dodge & Toyota, Nissan	EZS7-06
Plug n Play	Old Dodge	EZS7-06D

Côté remorque seulement / Trailer side only

4' Câble de remorque avec support pour prise à fermeture automatique 4' Trailer cable w/ self closing plug holder		EZS7-07
--	--	----------------

CONNECTEURS IMPERMÉABLES POUR VERSION 5° ROUE EZS7 / EZS7 5TH WHEEL VERSION WATERPROOF CONNECTORS



Ens. complets avec connecteur côté remorque de 8' / Complete Kits w/ 8' Trailer end

Hardwired 4'	Truck	EZS7-08/EZS7-10
T-Connectors w/7'	GM, Ford, New Dodge & Toyota, Nissan	EZS7-09/EZS7-10
T-Connectors w/7'	Old Dodge	EZS7-09D/EZS7-10

Côté véhicule seulement / Vehicle side only

Hardwired 4'	Truck	EZS7-08
T-Connectors w/7'	GM, Ford, New Dodge & Toyota, Nissan	EZS7-09
T-Connectors w/7'	Old Dodge	EZS7-09D

Côté remorque seulement / Trailer side only

8' Câble de remorque avec support pour prise à fermeture automatique 8' Trailer cable w/ self closing plug holder		EZS7-10
--	--	----------------

ADAPTATEURS / ADAPTERS

N



EZR7-51
Adaptateur 7 femelle à 7 mâle
7 female to 7 male adapter



EZR7-52
Adaptateur 7 mâle à 7 femelle
7 male to 7 female adapter



EZR7-54
Adaptateur 7 mâle à 4 femelle
7 male to 4 female adapter



EZR7-56
Adaptateur 7 mâle à 6 femelle
7 male to 6 female adapter



TERMINAUX SANS SOUDURE / SOLDERLESS TERMINALS

CONNECTEURS PARALLÈLES PARALLEL CONNECTORS

Sac de 100 / Bag of 100



TB18-100
Rouge / Red
Calibre 18-22 gauge



TB14-100
Bleu / Blue
Calibre 14-16 gauge



TB10-100
Jaune / Yellow
Calibre 10-12 gauge

TERMINAUX RONDS (BLEU) RING TERMINALS (BLUE)

Sac de 100 / Bag of 100 • Calibre 14-16 gauge



TR1408-100
#8



TR1410-100
#10



TR1414-100
1/4"

TERMINAUX RONDS (JAUNE) RING TERMINALS (YELLOW)

Sac de 100 / Bag of 100 • Calibre 10-12 gauge



TR1008-100
#8



TR1014-100
1/4"



TR1038-100
3/8"

DISCONNECTEURS FEMELLES FEMALE DISCONNECTS

Sac de 100 / Bag of 100

Calibre 14-16 gauge



TSF14187-100
Bleu / Blue • 3/16"

Calibre 10-12 gauge



TSF14250-100
Jaune / Yellow • 1/4"

DISCONNECTEUR MALE MALE DISCONNECT

Sac de 100 / Bag of 100

Calibre 14-16 gauge



TSM14187-100
Bleu / Blue • 1/4"

CONNECTEURS RAPIDES TAP SPLICE CONNECTORS

Bleu / Blue
Calibre 14-16 gauge



TC14-100
Sac de 100
Bag of 100

Sac de 100 / Bag of 100
Calibre 10-12 gauge



TC10-100
Jaune
Yellow

TERMINAL RELAY

Vendu à l'unité / Sold per unit



D38665
Chevy Equinox 07-13,
Ford Escape 08-13,
Mazda Tribute 08-13

MANCHONS CONNECTEURS THERMORÉTRACTABLES / HEAT SHRINKABLE BUTT CONNECTORS



HB10-10
10 pcs

Jaune / Yellow
Calibre 10-12 gauge

HB10-50
50 pcs



HB14-25
25 pcs

Bleu / Blue
Calibre 14-16 gauge

HB14-100
100 pcs



HB18-25
25 pcs

Rouge / Red
Calibre 18-20 gauge

HB18-100
100 pcs



ASSORTIMENT DE CONNECTEURS ET DE TERMINAUX THERMORÉTRACTABLES HEAT SHRINKABLE TERMINALS & CONNECTORS VARIETY PACK

Contient 120 pièces / Contains 120 pieces

T9904

- 40 manchons de connecteur thermorétractables
- 30 cosses à fourche thermorétractables
- 30 cosses à anneau thermorétractables
- 20 cosses rapides thermorétractables

- 40 heat shrinkable butt connectors
- 30 heat shrinkable fork terminals
- 30 heat shrinkable ring terminals
- 20 heat shrinkable slide terminals



TERMINAUX SANS SOUDURE SOLDERLESS TERMINALS PRISES "SNAP" / SNAP PLUGS

Sac de 100 / Bag of 100 • Calibre 14-16 gauge



P5986
Bleu / Blue • .156

CÂBLES PLAT À 4 FILS FLAT 4 WIRE CABLES



P90164E
16 ga. • 4 cond • 100'
Plat enrobé / Flat sheath

RT1046
16 ga. • 4 cond • 100'

RUBAN À DAMIER / CHECKER TAPE

3" x 15'



TPLRE7016
Blanc et noir
Black and white

**RUBAN POUR RÉPARATION
REPAIR TAPE**

Polyéthylène clair / Clear polyethylene



3" x 15'

TPLRE3848
Ruban de réparation pour
auvent de véhicule récréatif (très fort)
Ultra strong R.V. awning repair tape

**RÉFLECTEUR
POUR ENTRÉE
REFLECTIVE
DRIVEWAY
MARKER**



TPLRE1608
4" • Rouge / Red
Fibre de verre
Fiberglass

**RUBAN À ÉTANCHÉITÉ SUPÉRIEUR
SUPER SEAL TAPE**



Adhère aux surfaces sèches ou mouillées,
huileuses ou sales. Supporte 100lb/po² à 220° F.
Works on wet, dry, greasy or dirty surfaces.
Holds 100 psi at 220° F



TPLRE3845EF
1" x 16'

**PRÉSENTOIR DE
RUBAN ANTIDÉRAPANT
ANTI-SLIP SAFETY
GRIT TAPE
MERCHANDISER
DISPLAY**



TPLMR120
Inclut / Includes

1 rouleau/roll 1" x 60' **TPLRE141** (noir/black)
1 rouleau/roll 2" x 60' **TPLRE142** (noir/black)
1 rouleau/roll 4" x 60' **TPLRE160** (noir/black)

**RUBAN GRANULEUX
ANTIDÉRAPANT
ANTI-SLIP SAFETY GRIT TAPES**



TPLRE141
1" x 60'
TPLRE142
2" x 60'
TPLRE160
4" x 60'
TPLRE161
6" x 60'

**RÉFLECTEURS AUTOCOLLANTS
STICK-ON REFLECTORS**

EN ROULEAU (50 PAR ROULEAU)
IN BULK ROLLS (50 PER ROLL)



TPLRE7076
2" x 3 1/2"
Rouge / Red



TPLRE7074
3" dia
Rouge / Red
Vendu à l'unité / Sold per unit



**COURROIE
ANTISTATIQUE
STATICLEAR
STATIC STRAP**



**VENDU À L'UNITÉ
SOLD PER UNIT**

AP11870

RUBAN ADHÉSIFS RÉFLÉCHISSANTS ET BRILLANTS HIGH INTENSITY REFLECTIVE TAPE PRODUCTS



	Description	Qté/Qty	Longueur/Length
PF2600	Rouge/Blanc / Red/White	4	2" x 12"
PF2610	Blanc / White	2	2" x 12"
PF2640	Jaune / Amber	2	2" x 12"

MARQUEUR POUR ENTRÉE DRIVEWAY MARKER



PF2667
72"
Ressort en acier inoxydable
Stainless steel spring

RÉFLÉCTEURS AUTOCOLLANTS STICK-ON REFLECTORS

Paquet de 2 / Pack of 2

1 3/8" x 3 3/8"	1 5/8" x 4 1/4"	2 1/4" dia.
PF2652 Rouge Red	PF2653 Jaune Yellow	PF2654 Rouge Red
PF2655 Jaune Yellow	PF2656 Rouge Red	

RÉFLÉCTEURS POUR ENTRÉE DRIVEWAY MARKERS

Telescopique / Telescopic
Visibilité 360° / 360° Visibility
46"-72"



PF2669
46"
Aluminium blanc
White aluminum



PF2666
Bleu - Blanc
Blue - White



PF2665
Rouge - Blanc
Red - White



LUMIÈRE CLIGNOTANTE DE SÉCURITÉ À DEL FLASHING LED SAFETY LIGHT



L-1409
11" x 8" x 3" • 1.6 km

- Étanche
- Endos magnétique puissant
- Mode lampe de poche d'urgence
- Waterproof
- Strong magnetic back
- Emergency flashlight mode

GOUPILLE À SERRURE DOUBLE CROCHET TWIN GRIP LOCKING RECEIVER PIN



WGP1001S
1/2" dia.

Attelage / Hitch: 1 1/4" x 1 1/4"

- Prévient le vol d'attelage
- Nouveau design double crochet
- Fonction de verrou plat
- Plaqué chrome
- Vient avec 2 clés
- Prevent ball mount theft
- New twin grip design for easy action
- Dead bolt construction
- Chrome plated
- Complete with two keys

ENS. DE BOUCHON ANTIPOUSSIÈRE WHEEL BEARING PROTECTOR KIT

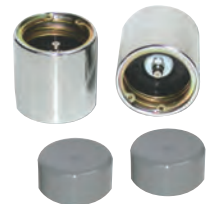

WGP111S
1.98" dia.

FEUX DE GABARIT / CLEARANCE LAMPS

Lumière seulement / Light only • 4 1/16" x 1 3/8"



30-99-001
Rouge / Red

30-99-002
Jaune / Amber

Lentilles de rechange / Replacement lens



4" x 2" x 1"

30-47-811
Rouge / Red

30-47-812
Jaune / Amber

Lumière de rechange / Replacement light

3 3/16" x 1 1/32" x 1 1/16"



40-39-001

Rouge/Red
Pour/For: LB1020R & MC-99RB

3 7/8" x 1 13/16" x 1/2"



30-68-510

Jaune avec joint en mousse / Amber with foam gasket

LUMIÈRES D'AILE / FENDER LIGHTS

3 11/16" x 1 5/16" x 1 1/2" • 1/2" profondeur / depth



40-40-004

Rouge & Jaune. Avec base et vis.
Red & Amber. With base and screws



40-40-104

Lentille rouge & jaune de rechange
Red & Amber Replacement lens
Pour / For : 40-40-004

LUMIÈRES DE TRAVAIL À DEL / LED WORK LAMPS



54209-001
6 Diodes

4.5" Dia x 1 1/2" depth
Lumière circulaire à DEL
Circular LED light



54209-002
10 Diodes

4" x 4" x 1 1/2" depth
Lumière rectangulaire à DEL
Rectangular LED light

FEU DE POSITION ROUGE RED MARKER LAMP

Hamsar



H84005
9 Diodes

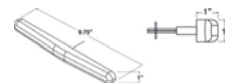

60" de filage. Ruban adhésif double face 3M À l'arrière. Lentille en polycarbonate - ne casse pas. Pour usage extérieur, résiste au rayon UV. 12V-13.4Vdc. Conforme avec SAE/DOT.
60" wire lead. 3M flat double sided tape adhesive back. Polycarbonate lens - will not break. UV resistant for outdoor use. 12V - 13.4Vdc. SAE/DOT compliant.

LUMIÈRES À DEL AVEC CONTOUR DE CAOUTCHOUC / LED LIGHTS WITH GROMMET



Connecteur 7" / 7" pigtail
Lumière : 0.75" • Contour : 1" • 1 diode

54201-003

Vendu à l'unité / Sold per unit
Emballé / Packaged
Ambre / Amber

54201-004

Vendu à l'unité / Sold per unit
Emballé / Packaged
Rouge / Red

54201-005

Vendu à l'unité / Sold per unit
Emballé / Packaged
Clair / Clear

54201-006

Vendu en vrac / Sold in bulk
Ambre / Amber

54201-007

Vendu en vrac / Sold in bulk
Rouge / Red

54201-008

Vendu en vrac / Sold in bulk
Clair / Clear

PILOT™

ENS. DE LUMIÈRES DE REMORQUAGE TOW LIGHT KIT



PNV-5041

Lumière rouge / Red lens
2-3/16"(H) x 1-1/4" (W)

2 pcs avec base magnétique / 2 pcs with magnetic base



LAMPES DE TRAVAIL ROBUSTES À DEL HEAVY DUTY LED WORK LAMPS



PNV-700

3" x 5" • Clair / Clear



PNV-720

4" x 6" • Clair / Clear



PNV-710

4" dia. • Clair / Clear



FEUX DE GABARIT CLEARANCE LAMPS

LED

DEL • LUMIÈRES SEULES / LED • LIGHTS ONLY

LED



2" • 4 Diodes

LED2000-4A
Ambre / Amber

LED2000-4R
Rouge / Red



2" • 1 Diodes

LED2000-1A
Ambre / Amber

LED2000-1R
Rouge / Red



LED2000-10A
Ambre / Amber
2" dia. 10 Diodes

LED2000-10R
Rouge / Red
2" dia. 10 Diodes

LED2500-13A
Ambre / Amber
2 1/2" dia. 13 Diodes

LED2500-13A
Ambre / Amber
2 1/2" dia. 13 Diodes

LED2500-13R
Rouge / Red
2 1/2" dia. 13 Diodes

4" x 3/4" • Avec montage à surface / With surface mount • 7 Diodes



LED0750A
Ambre / Amber

LED0750R
Rouge / Red

4" x 1" • Scellé/Sealed • 4 Diodes



LED1040-4A
Ambre / Amber

LED1040-4R
Rouge / Red

LUMIÈRES SEULES / LIGHTS ONLY

Scellé / Sealed • 2 1/2" x 1 1/4"



SE1225A
Ambre / Amber

SE1225R
Rouge / Red

2 ampoules / 2 bulbs • Scellé / Sealed • 4" x 1"



SE1040A
Ambre / Amber

SE1040R
Rouge / Red

LUMIÈRES AVEC BASE / LIGHTS WITH BASE

Base chromée / Chromed base
4" x 2"



ML2045A
Ambre / Amber

ML2045R
Rouge / Red

Base grise / Grey base
4" x 1 1/4"



KT2140A
Ambre / Amber

KT2140R
Rouge / Red

Base blanche / White base
3 1/2" x 1"



ML1030A
Ambre / Amber

ML1030R
Rouge / Red

Base blanche / White base
4" x 2"

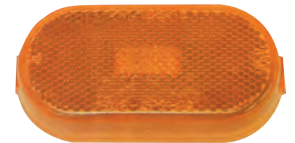

MR2041A
Ambre / Amber

MR2041R
Rouge / Red

DEL • LUMIÈRES AVEC BASE / LED • LIGHTS WITH BASE

LED



"BULLSEYE"

4" x 2" • 10 Diodes
Avec base / With base

LED2040A
Ambre / Amber

LED2040R
Rouge / Red



FEUX DE POSITION / SIDEMARKER LIGHTS

LED



11-230-1C
Ambre/Amber. 2". 5 DEL/LED.
Nécessite contour GR2000 & connecteur PT6020
Requires grommet GR2000 & PT6020 pigtail



SE2000A
2" dia.
Ambre / Amber • Scellée / Sealed

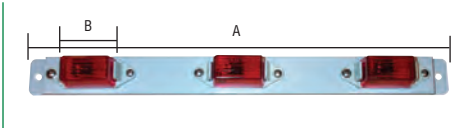

LB1020R
Rouge / Red
A = 15 1/4" x 1 3/8"
B = 1" x 2 3/4"

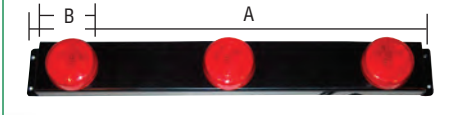

LB2000R
Rouge / Red
A = 16" x 2"
B = 1 3/4" dia.



**ENS. DE LUMIÈRE
LIGHT KITS**

ENSEMBLES DE LUMIÈRES / LIGHT KITS



KT3255A
2 1/2" dia.
Ambre / Amber
Scellée / Sealed



KT3255R
2 1/2" dia.
Rouge / Red
Scellée / Sealed

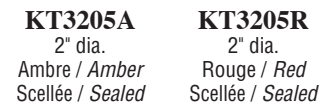

KT3205A
2" dia.
Ambre / Amber
Scellée / Sealed



KT3205R
2" dia.
Rouge / Red
Scellée / Sealed



KTR5400R
4" dia.
Rouge / Red • Scellée / Sealed
Vendu à l'unité / Sold per unit



KT3260R
6 1/2" x 2 1/4"
Connecteur et contour en caoutchouc inclus
Connect plug and rubber gasket included

DEL • ENSEMBLE DE LUMIÈRE / LED • LIGHT KIT

LED



KTL2001-4A
Ambre / Amber

LED



KTL2001-4R
Rouge / Red

LED4000C-24R
Lentille claire, DEL rouge / Clear lens, red LED
Lumière seul / Single light

FEUX ARRIÈRES 4" SCÉLLÉS COMPLÈTES / COMPLETE 4" SEALED REAR LIGHTS



KT3405W
Blanc / White

Incl.: fil et joint
Wire & gasket

KT3405A **KT3405R**
Ambre / Amber Rouge / Red

**DEL / LED
ENS. DE LUMIÈRE STROBOSCOPIQUE
MINI STROBE KIT**

LED



E-985AK
Lumière ambre / Amber lights

LATÉRALE / FENDER MOUNT

LED



LFML1225RA
Côté gauche
Rouge / Ambre
Left hand lamp
Red / Amber

LED



LFMR1225RA
Côté droite
Rouge / Ambre
LED right hand lamp
Red / Amber

Lumière incandescente
Incandescent light

FML1225RA **FMR1225RA**
Côté gauche Côté droite
Rouge / Ambre Rouge / Ambre
Left hand lamp Right hand lamp
Red / Amber Red / Amber

BARRE LUMINEUSE À DEL POUR ARRÊT/VIRAGE/CLIGNOTANT / LED STYLE-SIDE STOP/TURN/ID LIGHT BAR



J-5354R
15 1/2" L x 3/4" H x 1 5/8" W
11 diodes • Rouge / Red





FEUX D'ARRÊTS, ARRIÈRES & SIGNALISATIONS STOP, TAIL & TURN LIGHTS

DEL • ENSEMBLES DE LUMIÈRE / LED • LIGHT KITS

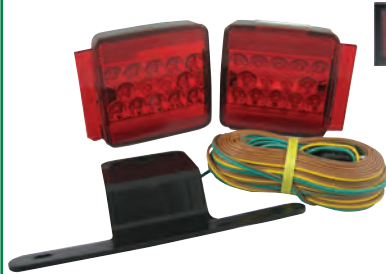

LED

14 diodes
LTL5451K
Avec feux de position de côtés.
Pour véhicule de moins que 80".
*With sidemarker lights.
For vehicle under 80".*

ENSEMBLES DE LUMIÈRE / LIGHT KITS

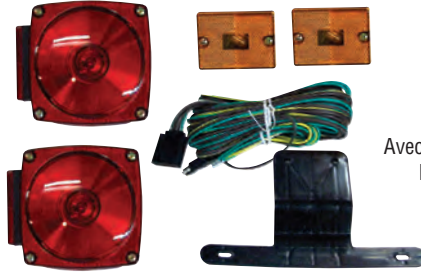

TL4400K
Avec feux de position de côtés
With sidemarker lights



LED

15 diodes
LTL7101K
Avec feux de position de côtés.
Pour véhicule avec plus que 80".
*With sidemarker lights.
For vehicle over 80".*

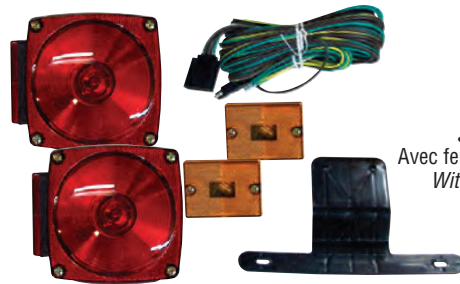

Jammy
J-2024KCD
Avec feux de position de côtés
With sidemarker lights

LUMIÈRES SEULES / LIGHTS ONLY

5 1/4"L x 4 1/2"W x 2 7/8"H



TL5441
Feux d'arrêt/signalisation
Stop and tail lights

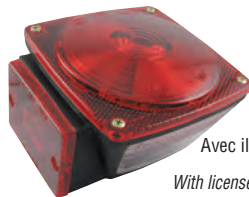

Avec illuminateur de plaque
With license illuminator

TL5441L
Feux d'arrêt/signalisation
Stop and tail lights

4 1/4" x 3 1/2"



TL4402 **TL4402L**
Régulier Avec lumière de plaque
Regular With license lamp

5 3/4"L x 6 3/4"W x 3"H



TL6400
Rouge / Red
Vendu en vrac / Sold in bulk

DEL • LUMIÈRES SEULES / LED • LIGHTS ONLY

5 1/2" x 1" • 24 Diodes



LRF4000-24R
Rouge / Red

4" dia. • 56 Diodes
Lumière de remplacement/Replacement light



LED4000-56W **LED4000-56R**
Blanc / White Rouge / Red

5 7/8"L x 6 3/4"W x 2 7/8"W



LTL6400
DEL Gauche/Droit / Left/Right LED (16 Diodes).
Recul/Back-up light (18 diodes).
Lumière de licences/Licence light (4 diodes).

4" • 12 Diodes



LED4000T-12R
Rouge (Double fonction)
Red (Double function)



SPT

LED

FEUX DE SIGNALISATION À DEL / LED SIGNAL LIGHTS

Vendu à l'unité / Sold per unit

LED



E-940A
4 1/4" dia. 1 3/4"H
24 diodes
Jaune. Stroboscope
Amber. Strobe



E-920A
6 1/2" x 2 1/4" • 24 diodes
Jaune. Stroboscope / Amber. Strobe



E-921A
6 1/2" x 2 1/4" • 35 diodes
Jaune. Flèche. Séquentiel. / Amber. Arrow. Sequential.



Uni-Bond Lighting Canada

LUMIÈRES DE REMORQUAGE / TOW LIGHTS



TW4402R

Monture d'arrêt
incrusté/direction/lumière arrière
4 câbles minces de 20 pieds avec
raccords & connecteurs de remorques
Peinture en polypropylène

Stud mount stop/ Turn/ Tail lamp
20ft 4-wire flat ribbon cable
with trunk & trailer connectors
Polypropylene hinge flaps



TW4000R
Monture magnétique,
câble 30' à grande capacité
avec connecteur 4"
Magnetic mount tow
lights, 30' heavy duty
cable with 4" connector

LED



TW4100-12R
4 1/2" dia. Rouge/Red
Aimant/Magnet. 3" x 3"
Magnétique à haut rendement.
Heavy duty magnetic

LED

LUMIÈRES DE TRAVAIL À DEL / LED WORK LIGHTS

LED



LW4603
Lumière
circulaire à DEL
Circular LED light
6 Diodes • 5" dia.



LW4602
Lumière
circulaire à DEL
Circular LED light
6 Diodes • 5" dia.



LW5003
Lumière
circulaire à DEL
Circular LED light
19 Diodes • 4.5" dia.



HiD5052
Lumière carré
Zenon HID
HD Zenon square light
75 000 CP • 5 1/2" x 5 1/2"



HiD5053
Lumière carré
Zenon HID
HD Zenon square light
190 000 CP • 5 1/2" x 5 1/2"

LAMPE DE TRAVAIL / WORK LAMP

Vendu à l'unité / Sold per unit



AX7606H
50 Watts
4 7/8" dia. x
5 7/8"H x 3"P/D
Halogène à faisceau large
Halogen flood

LUMIÈRE DE TRAVAIL À DEL LED WORK LAMP 8 Diodes



LW5040
0.8 Amp
4 3/8"L x 4 7/8"H x 1 7/8"P/D
Boîtier en aluminium / Aluminum housing



AG4620
Lampe de travail à double
réflecteur incluant 2
ampoules halogène
remplaçable H3 - 55W
Work lamp with double
reflector including
2 H3 - 55W halogen
replaceable bulbs



LUMIÈRES D'INTÉRIEURES / INTERIOR DOME LIGHTS

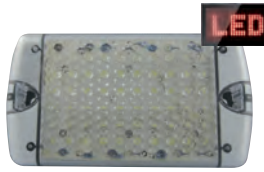

LDL7550C
7" L x 4" H x 1 3/8" P/D • 60 Diodes
Clair/Clear



LDL8015C
8 1/4" L x 1 5/8" H x 3/4" P/D • 60 Diodes
Clair avec interrupteur / Clear with switch



DL3050S
3 1/2" x 5 1/4"
Avec interrupteur / With switch



LDL6000C
5 5/8" dia. x 1 1/8" • 40 diodes

Jammy

LUMIÈRES POUR PLAQUE / LICENSE PLATE LIGHTS



J-422S-C
4 1/2" L/W x 2 1/2" H x 2" D
Avec interrupteur / With switch



LP3000
Chrome



LLP2002
12 Diodes



LP2002
3 1/2" x 2 1/4"
Completo / Complete



LP1002
2 1/8" x 2 11/16"
Sans joint d'étanchéité / No Seal

Jammy

SUPPORT POUR PLAQUE AVEC LUMIÈRE / LICENSE PLATE WITH LIGHT



J-99BRK
1 7/8" L/W x 2 1/4" H x 1 1/2" D
Plastique et métal / Plastic and steel



CONTOUR DE CAOUTCHOUC / RUBBER GROMMETS

Jammy

J-10GM
Contour de caoutchouc 2". Ouvert.
Grommet 2". Open back.

CONTOURS DE CAOUTCHOUC / RUBBER GROMMETS

Vendu à l'unité / Sold per unit



GR2000
2" dia.

GR2500
2 1/2" dia.



GR4000
4" dia.
Lumière non incluse
Light not included



GR2239
Fermé / Closed
7 1/4" x 2 1/4"
Lumière non incluse
Light not included



GR1225
Contour de caoutchouc
Mounting grommet
Pour/For. SE1225A & SE1225R



MB2238
Support de montage pour KT3260R
Mounting bracket for KT3260R

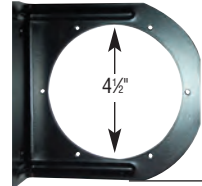

MB4000
Support de montage
Mounting bracket

BASE POUR LUMIÈRE DE 1" X 4" / BASE FOR 1" X 4" LAMPS



BM1040BB
Base noire seulement / Black base only

CONNECTEUR 2 CONTACTS / TWO PRONG PIGTAIL



PT6020

CONNECTEUR / PIGTAIL

Vendu à l'unité / Sold per unit



PT9530
3 wires

JUNCTION BOX



JB0700
7 bornes / 7 studs • 6 1/2" L x 3 1/4" H x 2 1/4" P/D

CONNECTEURS / CONNECTORS



PT6004
Filage 4 conducteurs plats
4 wire cable
5' remorque/5' trailer
Auto/Car

PT2505
Filage 4 conducteurs
4 wire cable Wishbone.
25' remorque/25' trailer
4' auto/4' car

RÉFLECTEURS AVEC ADHÉSIF / REFLECTORS WITH ADHESIVE

Vendu à l'unité / Sold per unit



Jammy

J-002A
Ambre / Amber

3 1/4" x 1 3/16"

J-002R
Rouge / Red

FEUX D'ARRÊTS, ARRIÈRES & SIGNALISATIONS STOP, TAIL & TURN LIGHTS



ENSEMBLES DE LUMIÈRE / LIGHT KITS



TL-27BK

Avec feux de position de côtés / *With sidemarker lights*



Submersible universel
Submersible universal

TL-14RK

Avec feux de position de côtés / *With sidemarker lights*

LED

DEL • LUMIÈRES SEULES / LED • LIGHTS ONLY

LED



STL-17RB

8 1/16" x 2 7/8" • **18 (+4) diodes.**
Submersible gauche. 80" et plus.
Avec illuminateur de plaque.
*Left submersible with license
illuminator. Over 80".*

STL-16RB

8 1/16" x 2 7/8" • **18 diodes**
Submersible droit. 80" et plus.
Submersible. Right. Over 80".

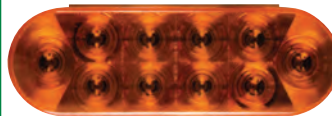

STL-72RB

6 1/2" x 2 1/4" • **10 diodes**
Lumière ovale rouge à DEL.
Lumière seulement.
LED Red oval light. Light only.

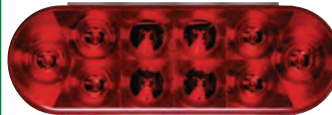

STL-72AB

6 1/2" x 2 1/4" • **10 diodes**
Lumière ovale ambré à DEL.
Lumière seulement.
LED Yellow oval light. Light only.



STL-78RB

7 9/16" x 3 5/16" • **10 diodes**
Lumière ovale rouge à DEL / *LED Red oval light*



STL-12RB

6 1/2" x 2 1/4" • **6 diodes**
Rouge / *Red* • Scellée / *Sealed*



STL-13RB

4" dia. • **7 diodes**
Rouge / *Red*
Scellée / *Sealed*



STL-9RB
16 (+5) diodes

Avec lumière de plaque.
Côté gauche. Rouge.
With license light. Left side. Red

STL-8RB

Pour côté droit. Rouge.
For right side. Red.
16 diodes

AL-9RB

Lentille de remplacement / *Replacement lens*
Pour/For: **STL-8RB, STL-9RB** (Côté/Side)



A-8RB

Lentille de
remplacement
Replacement lens

A-9RB

Lentille de côté de
remplacement
*Replacement
side marker lens*



ST-4RB

Feu rouge arrière.
Côté droit.
*Red tail light. Right
side.*

ST-5RB

Feu rouge arrière avec
lumière de plaque.
Côté gauche.
*Red tail light with
licence light. Left side.*



ST-16RB

Rouge. Côté droit.
Red. Right side.

ST-17RB

Avec réflecteurs
de côtés et
arrières
*With side and
rear markers*
Avec lumière pour plaque.
Rouge. Côté gauche.
*With licence light. Red.
Left side.*



4 5/16" x 3 3/8"

ST-25RB

Feu rouge arrière avec
lumière de plaque.
Côté gauche.
*Red tail light with
licence light. Left side*

LUMIÈRES SEULES / LIGHTS ONLY

4 9/16" x 6 1/8" • **SUBMERSIBLE**

8 1/16" x 2 7/8" • **SUBMERSIBLE**

FEUX DE GABARIT / CLEARANCE LAMPS

LUMIÈRES AVEC BASE / LIGHTS WITH BASE



MC-91AB
2 1/2" x 1 3/16"
Ambre / Amber
Base chromée / Chromed base

MC-91RB
2 1/2" x 1 3/16"
Rouge / Red
Base chromée / Chromed base

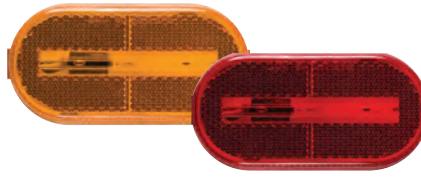

MC-38AB
4" x 2 1/16"
Ambre / Amber
Base blanche / White base

MC-38RB
4" x 2 1/16"
Rouge / Red
Base blanche / White base



MC-36AB
2 3/4" x 2 1/8"
Ambre / Amber
Base noire / Black base

MC-36RB
2 3/4" x 2 1/8"
Rouge / Red
Base noire / Black base



MC-66AB
4" x 2 1/16" • Ambre / Amber
2 ampoules avec base blanche. Dôme.
2 bulbs with white base. Domed.



MC-31AB
4" x 2 1/16"
Ambre. Lumière seulement.
Réfléchissant. Base noire.
Amber. Light only. Reflective. Black base.

ENSEMBLES DE LUMIÈRES AVEC BASE / LIGHT KITS WITH BASE



MC-44RB
4" x 1 1/2"
Rouge / Red
Base blanche / White base



MC-68AB
3 1/2" x 1"
Ambre / Amber
Base blanche/White base

MC-68RB
3 1/2" x 1"
Rouge / Red
Base blanche/White base



BA-44FNL
Lumière d'aile avec base (gauche)
Fender light with base (left)
Rouge & ambre / Red & Amber

BA-44FNR
Lumière d'aile avec base (droit)
Fender light with base (right)
Rouge & ambre / Red & Amber

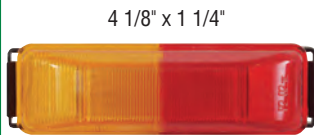

4 1/8" x 1 1/4"

MC-67ARB
Lumière d'aile rouge & ambre.
Inclus support et prise à 2 fils
Red & amber fender light kit
Includes bracket and 2 wire plug



A-67BB
Base pour lumière
Fender light base

RÉFLECTEURS / REFLECTORS



RE-9AB
Ambre / Amber
4 3/8" x 1 7/8"

RE-11RB
Rouge / Red
4 3/8" x 1 7/8"



RE-35AB
Ambre / Amber
2 3/16" dia.

RE-35RB
Rouge / Red
2 3/16" dia.

ENSEMBLE DE LUMIÈRES / LIGHT KITS



ST-44RB
4" dia. • Rouge / Red
Non réfléchissante / Non reflecting



BU-74CB
6 1/2" x 2 1/4"
Clair / Clear

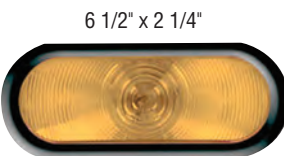

6 1/2" x 2 1/4"

ST-74AB
Ambre / Amber

ST-70AB
Lentille de remplacement
Replacement lens

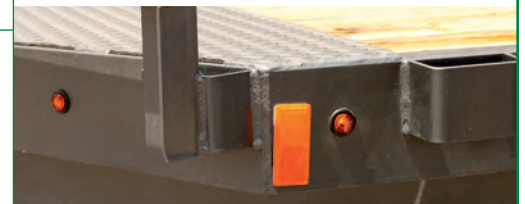

LUMIÈRE SEULE / LIGHT ONLY



MC-65ARB
4 1/8" x 1 1/4"
Pour/For. MC-67ARB



ST-45RB
4" dia.
Rouge / Red

ST-46RB
4" dia. • Rouge / Red
Réfléchissante / Reflecting



FEUX DE GABARIT CLEARANCE LAMPS

LED

DEL • LUMIÈRES SEULES / LED • LIGHTS ONLY

LED



MCL-61ARB

4" x 1 1/4" • 2 diodes

Lumière d'aile à DEL / LED Fender light
Rouge & ambre / Red & Amber



MCL-65ARB

3 3/4" x 7/8" • 6 Diodes

Lumière d'aile à DEL / LED Fender light
Rouge & Ambre / Red & Amber



MCL-61AB

4" x 1 1/4" • 2 diodes

Ambre / Amber
Scellée / Sealed

MCL-61RB

4" x 1 1/4" • 2 diodes

Rouge / Red
Scellée / Sealed



MCL-56AB

2" dia. • 1 diodes

Ambre / Amber
Scellée / Sealed



MCL-56RB

2" dia. • 1 diodes

Rouge / Red
Scellée / Sealed



MCL-527AB

2 1/2" dia. • 2 diodes

Ambre / Amber
Scellée / Sealed



MCL-527RB

2 1/2" dia. • 2 diodes

Rouge / Red
Scellée / Sealed



AL-90AB

2 1/2" x 1 1/4" • 1 diodes

Ambre / Amber
Scellée / Sealed

AL-90RB

2 1/2" x 1 1/4" • 1 diodes

Rouge / Red
Scellée / Sealed

LED

DEL • LUMIÈRES AVEC BASE / LED • LIGHTS WITH BASE

LED



MCL-91AB

2 1/2" x 1 3/16" • 3 diodes

Ambre / Amber
Base chromée / Chromed base

MCL-91RB

2 1/2" x 1 3/16" • 3 diodes

Rouge / Red
Base chromée / Chromed base



MCL-67ARB

4 1/8" x 1 1/4" • 6 diodes

Ens. de lumière rouge & ambre
Red & amber light kit
(Base include: A-67BB)
(Base included : A-67BB)



A-67BB
Base pour
lumière
Fender light
base



MCL-36RB

2 7/8" x 2 1/8" • 6 diodes

Rouge / Red
Base noire / Black base

MCL-36AB

2 7/8" x 2 1/8" • 6 diodes

Ambre / Amber
Base noire / Black base



MCL-11RKB

3/4" W x 15/16" D • 2 diodes
Rouge / Red • 3/4" Scellée/Sealed
Avec contour / With grommet

LUMIÈRES AVEC BASE / LIGHTS WITH BASE



MC-11AB

3 3/16" x 1"

Ambre / Amber
Base noire / Black base

MC-11RB

3 3/16" x 1"

Rouge / Red
Base noire / Black base



MC-92AB

2 1/2" x 1 3/16"

Ambre / Amber
Base noire / Black base

MC-92RB

2 1/2" x 1 3/16"

Rouge / Red
Base noire / Black base



MC-35AB

3 5/16" x 2 3/8"

Ambre / Amber
Base noire / Black base

MC-35RB

3 5/16" x 2 3/8"

Rouge / Red
Base noire / Black base

FEUX DE POSITION / LIGHT BARS



MC-93RB
Rouge / Red
Scellée / Sealed
17" x 1 5/8"



MCL-93RB
Rouge / Red
3 (x3) DEL/LED
16 1/16" x 1 3/8"



MCL-83RB
Rouge/Red • 3 (x3) DEL/LED • Base noire / Black base

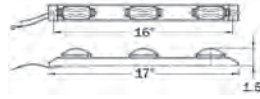

MC-99AB
Ambre / Yellow
15 1/16" x 1 3/8"
Base blanche/White base

MC-99RB
Rouge / Red
15 1/16" x 1 3/8"
Base blanche/White base



À INSTALLER SUR LE DESSUS OU LE CÔTÉ DE LA PLUPART DES AILES.
INDIQUE LE POINT LE PLUS LARGE DE LA REMORQUE
MOUNT ON TOP OR SIDE OF MOST FENDERS TO MARK WIDEST POINT ON TRAILER.

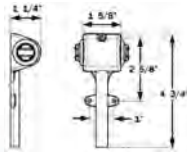

MCL12ARRB
Assemblage de lumière pour aile droite • 2 Diodes •
Right side fender light assembly

MCL12ARLB
Assemblage de lumière pour aile gauche • 2 Diodes •
Left side fender light assembly



MCL12RK3B
Ensemble de lumières avec harnais • 3 Diodes •
ID light kit with harness

SUPPORTS POUR PLAQUE LICENCE PLATE BRACKETS



LP-5SB
Plastique.
Antirouille.
Plastic. Rust proof.



LP-15SB
Plaqué zinc / Zinc plated

SUPPORT POUR PLAQUE ET LUMIÈRE LICENSE PLATE AND LIGHT BRACKET



LP-10SB
Plastique flexible. Support
à l'épreuve de la rouille.
Flexible plastic.
Rust proof bracket

LUMIÈRES DE PLAQUE / LICENSE PLATE LIGHTS



LPL-41CB
Clair / Clear
3 1/4" x 2 3/16" x 1 3/4"
5 Diodes



LPL-31CB
Clair / Clear
2" x 1 5/16" x 1 3/16"
2 Diodes



LP-41CB
2 5/8" x
2 3/16" x 1 3/4"



LP-51CB
2 5/16" x 3 1/4" x 1 3/4"



LP-97CB
Scellée / Sealed • 2 3/4" x 1 1/4" x 2 3/8"



LP-71CB
Chrome • Base : 3 3/8" x 2 3/8"

LUMIÈRE DE PLAQUE LICENSE PLATE LIGHT



LP-11CB
2" x 1 1/2"

CONTOURS DE CAOUTCHOUC RUBBER GROMMETS

Vendu à l'unité / Sold per unit



A-70GB
Pour 6" ovale
For 6" oval

SUPPORT DE MONTAGE / MOUNTING BRACKET

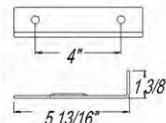

BK-45BB
Noir / Black



**ANNEAU CHROMÉ
CHROME RING**
A-78CB
Pour/For:
STL-78RB

BASE CHROMÉE POUR LUMIÈRE CHROMED BASE FOR LIGHT



A67B
Pour/For
MCL-61AB-CH,
MCL-61RB-CH,
MCL-61AB-B &
MCL-61RB-B

Jammy



**FEUX D'ARRÊTS,
ARRIÈRES &
SIGNALISATIONS
STOP, TAIL & TURN
LIGHTS**

DEL • LUMIÈRE SEULES / LED • LIGHTS ONLY



J-20245R
Diodes: 12+2
Régulier.
Côté droit. Rouge.
Regular.
Right side. Red.

5 1/2" x 4 1/2"

J-20245L
Diodes: 12+2+4
Régulier avec lumière de plaque.
Côté gauche. Rouge.
Regular with license light
Left side. Red.



J-66R
6 1/2" x 2 1/4"
10 diodes
Feu de signalisation.
Rouge.
Signalisation light. Red.

LUMIÈRES SEULES / LIGHTS ONLY



J-2024
Régulier.
Côté droit. Rouge.
Regular. Right side. Red.

5 1/2" x 4 1/2"

J-2024L
Régulier avec lumière de plaque.
Côté gauche. Rouge.
Regular with license light.
Left side. Red.



J-73
De côté / Curb side

8" x 3"
Feu arrière combiné
submersible. Profilé. Rouge.
Submersible combination tail
lamp. Low profile. Red.

J-73L
Côté rue / Street side



Uni-Bond Lighting Canada

DEL • LUMIÈRES SEULES / LED • LIGHTS ONLY



Vendu à l'unité / Sold per unit
6 1/2" x 2 1/4" x 1 5/8"
24 Diodes

LED2238-24A
Jaune / Amber

LED2238-24C
Clair / Clear

LED2238-24R
Rouge / Red



LED2238C-24R
Lentille claire, lumière rouge
Clear lens, red light

LUMIÈRES SEULES / LIGHTS ONLY

**FEU DE RECUIL OVAL
OVAL BACK-UP LAMP**

Vendu en vrac / Sold in bulk



SE2238W
Blanc. Scellé / White. Sealed



ENSEMBLES DE LUMIÈRE / LIGHT KITS

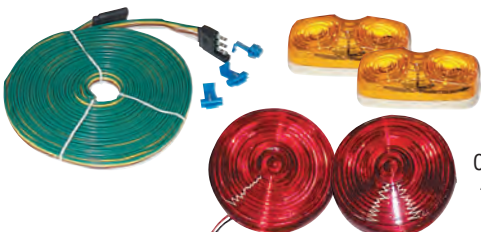

K76
23'
Connecteur plat à 4 fils
4 way flat connector

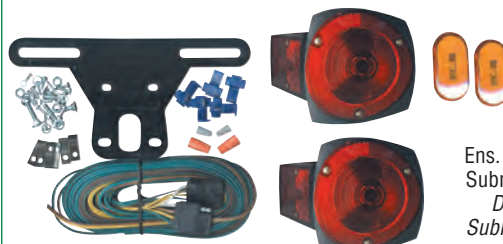



PT1110
Ens. de lumière deluxe.
Submersible universel.
Deluxe trailer kit.
Submersible universal.

Jammy

FEUX DE GABARIT / CLEARANCE LAMPS

LED	DEL • LUMIÈRES SEULES / LED • LIGHTS ONLY	LED
 <p>2 1/2" x 1 1/4" 2 diodes Scellée / Sealed</p> <p>J-5735A Ambre / Amber</p> <p>J-5735R Rouge / Red</p>	 <p>3 3/4" x 1 1/4" • 3 diodes • Scellée / Sealed</p> <p>J-5765A Ambre / Amber</p> <p>J-5765R Rouge / Red</p>	 <p>2 1/2" • 4 diodes</p> <p>J-25A Ambre / Amber</p> <p>J-25R Rouge / Red</p> <hr/> <p>2" • 4 diodes</p> <p>J-15A Ambre / Amber</p> <p>J-15R Rouge / Red</p>

LUMIÈRES SEULES / LIGHTS ONLY

 <p>6 1/2" x 2 1/4"</p> <p>J-60A Ambre / Amber</p> <p>J-60R Rouge / Red</p>	 <p>2" Scellée Sealed</p> <p>J-10A Ambre / Amber</p> <p>J-10R Rouge / Red</p>	 <p>2 1/2" Scellée. Réfléchissant. Sealed. Reflex.</p> <p>J-20A Ambre / Amber</p> <p>J-20R Rouge / Red</p>
--	--	---

 <p>3 3/4" L/W x 1 1/4" H x 7/8" D</p> <p>J-576A Ambre / Amber</p> <p>J-576R Rouge / Red</p>	LUMIÈRE À DEL AVEC BASE LED LIGHT WITH BASE	LUMIÈRE AVEC BASE LIGHT WITH BASE
	 <p>LED</p> <p>2 1/2" • 2 diodes Avec base noire / With black base</p> <p>J-515AB Ambre / Amber</p> <p>J-515RB Rouge / Red</p>	 <p>2 3/4" L/W x 2 1/8" H x 3/4" D Avec base noire / With black base</p> <p>J-1024A Ambre / Amber</p> <p>J-1024R Rouge / Red</p>

LENTILLE DE RECHANGE REPLACEMENT LENS	FEUX DE POSITION ROUGE RED MARKER LAMPS
 <p>4" x 2"</p> <p>J-323-15A Ambre / Amber</p> <p>J-323-15R Rouge / Red</p>	 <p>J-555-R 16 5/8" L/W x 1 1/2" H x 1 1/2" D • 2 diodes (x3) Rouge. Avec base noire. / Red. With black base.</p>
	 <p>J-500-3W-R 15 1/2" L/W x 1 1/4" H x 1 1/4" D Rouge. Avec base blanche en métal. Red. With white metal base.</p>



FEUX DE POSITION / MARKER LAMPS
 <p>Contours de caoutchouc inclus / Grommets included</p> <p>2 Diodes 3/4" dia.</p> <p>LED</p> <p>LED0700A Ambre / Amber</p> <p>LED0700R Rouge / Red</p>
 <p>11 Diodes • 17"L x 1 3/8"W x 1"H</p> <p>LLB1017P-11R Rouge / Red</p>

LAMPES DE COURTOISIE À DEL / LED COURTESY UTILITY LAMPS



H81116
3 Diodes

12V une lumière. Pas de lunette d'encadrement ou de bande adhésive. Idéal pour le dessous du tableau de bord, à l'intérieur des panneaux de porte, la zone de cargaison, etc.
12V one light. No bezel, no tape. Ideal for under dashboard, interior door panels, cargo areas, etc.

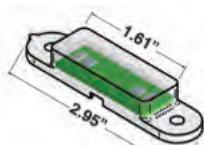

H81109
9 Diodes

12V. Bande adhésive. Boîtier robuste pour applications intérieur ou extérieur
12V tape mount adhesive. Tough rugged design for interior or exterior applications

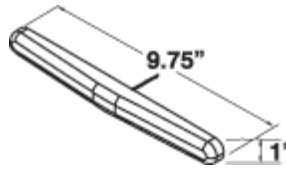

PLAFONNIER À DEL / LED DOME LAMPS



A81612

7" • 36 LED • 1270 Lumens
Avec interrupteur / Switched
Garniture blanche / White Bezel

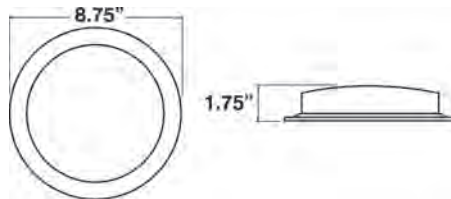

H81613

7" • 36 LED • 1270 Lumens
Sans interrupteur / Unswitched
Garniture blanche / White Bezel



H81104
6 Diodes

Blanc / White

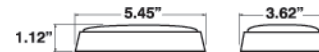

AVERTISSEURS DE MARCHÉ ARRIÈRE / BACK-UP ALARMS • 12/24V



H51010
87 db.

H51011
97 db.

H51012
107 db.

Boîtier de nylon
Nylon housing
4.08" x 2.75" x 1.75"



H51020
112 db. SAE/DOT

S'installe verticalement
ou horizontalement
Horizontal or Vertical mount
4.75" x 3.44" x 2.8"



AVERTISSEURS DE MARCHÉ ARRIÈRE / BACK-UP ALARMS

Température de fonctionnement / Operating temperature: -30°C à/to 55°C

Type européen / European style



BU97
SAE Type C
97db, < 0.6 Amp

12V - 24V



BU112
SAE Type A
127db, < 0.8 Amp

12V - 24V



HEA0896A
82 db - 12V

Jammy

CABLE DE SÉCURITÉ SAFETY CABLE



J-12060
12,000 lb
Câble de 60" avec crochet
Rated 60" cable with hook

LOQUET POUR BENNE TIPPERLATCH SPRING LOADED



J-TPR
Fait d'acier. Idéal pour remorque basculante.
Made of raw steel. Ideal for trailers that tilt.

CROCHETS POUR PORTE DOOR HOLDERS



Thermoplastique / Thermoplastic
J-19062 **J-19102**
6" 10"

Master Lock®

ATTACHE / TIE DOWN



3055DAT
Attache à rochet 1" x 14"
Crochets en "S" avec blocage
1,800 / 600 lbs
1" x 14" Ratchet Tie Down
"S" hooks with clips
1,800 / 600 lbs

SYSTÈME DE CAMÉRA COULEUR PORTABLE SANS FIL PORTABLE WIRELESS COLOR CAMERA SYSTEM



4843DATSEN
2 systèmes en un ! Pour tube d'attelage de 1 1/4" ou 2"
(lorsqu'on ne remorque pas). Avec base magnétique pour
monter sur surface en métal tout en remorquant ou en
attachant la remorque. Le support pour caméra peut pivoter
90° pour une visibilité accrue derrière le véhicule. Écran
couleur 3.5". Portée de 50'et plus @ 2.4Ghz
**2 systems in one ! Slides into 1 1/4" or 2" hitch tube for use
while not towing. Magnetic base for mounting to any metal
surface while towing or attaching the trailer. Camera bracket
can swivel 90 degrees for increased visibility behind vehicle.
Large 3.5" color monitor for easy viewing. 50+ ft. range @
2.4Ghz**



SYSTÈME DE CAMÉRA COULEUR PORTABLE SANS FIL (HINDSIGHT) HINDSIGHT PORTABLE WIRELESS COLOR CAMERA SYSTEM



D67300
Base magnétique. Vision de nuit. Angle de vue: 55°. Portée d'émission: 300'.
Écran couleur ACL de 2.4" (résolution: 480 x 240). Moniteur à 4 canaux
permet des caméras multiples. Le microphone est incorporée dans la
caméra. Batterie au lithium-ion (rechargement rapide). Se conforme aux
règlements du FCC
**Magnetic base. Night vision. Wide 55° viewing. Viewing distance over 300
feet. Full color portable 2.4" LCD monitor with 480 x 240 resolution. 4
channel monitor allows for multiple cameras. Microphone built into camera.
Quick rechargeable lithium-ion batteries. Complies to FCC regulations**



LUMIÈRE POUR BARRE DE TIRE BALL MOUNT HITCH LIGHT



PCR-607
Fait sur barre tire de 2". Pas besoin de retirer
pour remorquer. S'illumine lorsqu'en mode
reculons ou manuellement avec interrupteur
intégré
**Fits on 2" ball mount. No need to remove when
towing. Lights up in reverse or manually by
built-in switch**



CHARIOT AVEC BOULE D'ENCRAGE TRAILER DOLLY



TD600
600 Lbs. Boule de 1 7/8"
600 Lbs. 1 7/8" Hitch ball

Hamsar

LED

LUMIÈRE STROBOSCOPIQUE À DEL / LED STROBE LIGHT

Clignotement unique, 6 clignotements par cycle, 60 cycles par minute / *Single flash pattern, 6 flashes per cycle, 60 cycles per minutes*



N

H81512

9-36 VDC • 3.7" x 5.2"

Phare à DEL ambre. Monture permanente.
30 DEL carré. Modèle profilé.
Amber LED beacon. Permanent mount.
30 square LED's. Low profile.



N

H81516

9-36 VDC • 3.7" x 5.2"

Phare à DEL ambre. Monture aimantée.
30 DEL carré. Modèle profilé.
Amber LED beacon. Magnetic mount.
30 square LED's. Low profile.



N

H81519

9-36 VDC • 4.8" x 4.73"

Phare à DEL ambre. Monture permanente.
60 DEL carré. Modèle allongé.
Amber LED beacon. Permanent mount.
60 square LED's. High profile.



N

H81522

9-36 VDC • 4.8" x 4.73"

Phare à DEL ambre. Monture aimantée.
60 DEL carré. Modèle allongé.
Amber LED beacon. Magnetic mount.
60 square LED's. High profile.



GYROPHARES / REVOLVING LIGHTS



N

W7900A

DEL Ambre avec lentille claire. Modules 22 GEN 3 TIR (88 DEL à une watt). 15 différents motifs lumineux d'avertissement. 6 différentes configurations. Panneau de contrôle a un indicateur à DEL des séquences de clignotements et 10 boutons-poussoirs. Câble 12' du support à lumière au panneau de contrôle. Système de montage universel ajustable incluant une courroie en acier inoxydable pour montage sur le rebord de la fenêtre.

Amber LED's, clear lens. 22 GEN 3 TIR modules (88 one watt LED's). 15 selectable warning light patterns. 6 different patterns. Control panel has LED flash pattern indicator and 10 push button switches. 12' cable from light bar to switch control panel. Adjustable universal mounting system including stainless steel straps for window ledge mounting.

Dim.: 48" L x 12" W x 4" H. • 12V • 6.50 Amps.

PORTATIF & AMOVIBLE / PORTABLE & REMOVABLE



AURORA™

W3550MA*

12 Volts • 5.5 Amps
24" L x 12" W x 5 1/2"

- 2 Lumières halogènes rotatives
- Cordon 10' avec prise d'allume-cigare
- Aimants recouverts de caoutchouc
- Supports ajustables
- 2 Halogen rotating lights
- 10' cord with cigarette lighter
- Rubber covered magnets
- Adjustable brackets

*Base aimantée : Ne pas utiliser lorsque le véhicule est en mouvement
Magnetized base: Do not use while vehicle is in motion

PILOT™

GYROPHARE / REVOLVING LIGHT



PNV-5090A

Base magnétique. Ampoule simple avec réflecteur rotatif. Boîtier en plastique jaune robuste. Grandeur compacte et léger. Prise d'allume-cigare. Installation facile.

Magnetic base. Single bulb with rotating reflector Strong plastic amber housing. Compact size and light weight. Cigarette lighter plug. Easy installation.



GYROPHARES / REVOLVING LIGHTS

HAWKEYE™



W3000-A*
108 DEL haute intensité. 10 différentes configurations de lumières. Base aimantée. 5 clignotantes et 5 rotatives.
108 High intensity LED's. 10 different light patterns. Magnetized base. 5 Flashing and 5 rotating.

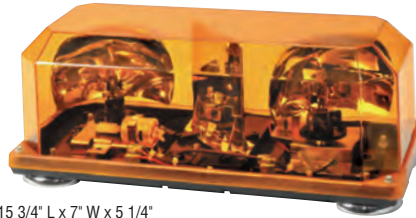

15 3/4" L x 7" W x 5 1/4"

Halogène H1 55 watts. Lampe d'avertissement 360°.
H1 halogen 55 watt. 360° warning light.

W3500M-A*
Monture aimantée. Cordon 7' avec prise d'allume-cigare. Magnet mount. 7' cord with cigarette lighter plug.

W3500P-A
Monture permanente. Allume-cigare **pas** inclus. Permanent mount. Cigarette lighter plug **not** included.



W3100-A*
Base aimantée. Cordon 10' avec prise d'allume-cigare Magnetized base. 10' cord with cigarette lighter plug



W3300-A*
Base aimantée, Cordon 10' avec prise d'allume-cigare 200,000 bougies Magnetized base, 10' cord with cigarette lighter plug 200,000 candle power

*Base aimantée : Ne pas utiliser lorsque le véhicule est en mouvement / Magnetized base: Do not use while vehicle is in motion



LUMIÈRES D'AVERTISSEMENT À DEL / LED WARNING LIGHTS



E-913A
Lumière d'avertissement à DEL, ambre
Amber LED Warning Light

3 diodes ambres. 12V - 24V. Base en aluminium enrobée de noir poudré et lentilles claires de polycarbonate. 12 configurations de clignotement. Dimensions de la lampe: 3 5/16" L X 1 1/16" H X 1 1/8" P.
3 amber diodes. 12V - 24V applications. Black powder coated aluminium base & clear polycarbonate lens. 12 flash patterns. Lamp dimension: 3 5/16" L x 1 1/16" H X 1 1/8" W.



E-913W
Lumière d'avertissement à DEL, blanche
White LED Warning Light

3 diodes blancs. 12V - 24V. Base en aluminium enrobée de noir poudré et lentilles claires de polycarbonate. 12 configurations de clignotement. Dimensions de la lampe: 3 5/16" L X 1 1/16" H X 1 1/8" P.
3 white diodes. 12V - 24V applications. Black powder coated aluminium base & clear polycarbonate lens. 12 flash patterns. Lamp dimension: 3 5/16" L x 1 1/16" H X 1 1/8" W.



E-915AA
Lumière d'avertissement à DEL, ambre / ambre
Amber / Amber LED Warning Light

Deux modules de 3 diodes ambres chacun. 12V - 24V. Base en aluminium enrobée de noir poudré et lentilles claires de polycarbonate. 19 configurations de clignotement, simultanés et en alternance. Dimensions de la lampe: 5" L x 1 1/16" H x 1" P.
Two modules of 3 amber diodes each. 12V - 24V applications. Black powder coated aluminium base & clear polycarbonate lens. 19 flash patterns including simultaneous & alternating flashes. Lamp dimension: 5" L x 1 1/16" H x 1" W



E-915AW
Lumière d'avertissement à DEL, ambre / blanche
Amber / White LED Warning Light

Deux modules de 3 diodes ambres et 3 diodes blanches. 12V - 24V. Base en aluminium enrobée de noir poudré et lentilles claires de polycarbonate. 19 configurations de clignotement, simultanés et en alternance. Dimensions de la lampe: 5" L x 1 1/16" H x 1" P.
Two modules of 3 amber diodes & 3 white diodes. 12V - 24V applications. Black powder coated aluminium base & clear polycarbonate lens. 19 flash patterns including simultaneous & alternating flashes. Lamp dimension: 5" L x 1 1/16" H x 1" W.

GYROPHARES À DEL LED REVOLVING LIGHT



E-350A
30 diodes • 12V
4" H x 5" Base dia.
Clignotement rotatif
Rotating flash

LUMIÈRE D'AVERTISSEMENT À DEL / LED WARNING LIGHT



Dimensions de la lampe
Lamp dimension:
9 3/4" L x 2" H x 6.77" P/W

E-2110AC
Clignotement quadruple, gauche et droite en alternance 30 DELs de 1W clairs. 12V - 24V.
Barre de lumières en ABS et lentilles en polycarbonate.
Quad flash alternating left & right. 30 1W clear LEDs. 12V - 24V applications. ABS base with polycarbonate lens.



LUMIÈRES D'AVERTISSEMENT À DEL / LED WARNING LIGHTS

E-2232AM

Barre de lumière d'avertissement à DEL de 23", ambre - Montage magnétique / 23" Amber LED Warning Light Bar - Magnetic Mount

- 12 configurations de clignotement
- 40 DELs de 1W ambres
- 12V - 30V
- Barre de lumières en aluminium et lentilles ambres en polycarbonate
- 2 aimants avec ventouses
- Adaptateur pour allume-cigarette avec bouton pour sélection de configuration et fil de 12.5'
- Dimensions de la lampe: 23"L x 2 3/16"H x 3 11/16"P
- 12 flash patterns
- 40 1W amber LEDs
- 12V - 30V applications
- Aluminum light bar with polycarbonate amber lens
- 2 magnets with suction cups
- Cigarette power adaptor with switch for flash pattern selection & 12.5 ft of wire
- Lamp dimension: 23"L x 2 3/16"H x 3 11/16"W



E-2150AM

Barre de lumière d'avertissement à DEL de 15", ambre - Montage magnétique / 15" Amber LED Warning Light Bar - Magnetic Mount

- Clignotement quadruple, gauche et droite en alternance
- 32 DELs de 1W ambres
- 12V - 30V
- Barre de lumières en aluminium et lentilles ambres en polycarbonate
- 2 aimants avec ventouses
- Adaptateur pour allume-cigarette avec interrupteur (on/off) et fil de 12.5'
- Dimensions de la lampe: 15"L x 2 3/16"H x 3 11/16"P
- Quad flash alternating left & right
- 32 1W amber LEDs
- 12V - 30V applications
- Aluminum light bar with polycarbonate amber lens
- 2 magnets with suction cups
- Cigarette power adaptor with on/off switch & 12.5 ft of wire
- Lamp dimension: 15" L X 2 3/16"H X 3 11/16"W



E-280AAM

Barre de lumière d'avertissement à DEL de 16.5", ambre - Montage magnétique / 16.5" Amber LED Warning Light Bar - Magnetic Mount

- Clignotement quadruple, gauche et droite en alternance
- 32 DELs de 1W ambres
- 12V - 30V
- Base en ABS avec dôme et lentilles ambres en polycarbonate
- 2 aimants avec ventouses
- Adaptateur pour allume-cigarette avec interrupteur (on/off) et fil de 11'
- Dimensions de la lampe: 16 1/2"L x 4 1/2"H x 8 1/16"W
- Quad flash alternating left & right
- 32 1W amber LEDs
- 12V - 30V applications
- ABS base with polycarbonate amber dome & amber lens
- 2 magnets with suction cups
- Cigarette power adaptor with on/off switch & 11 ft of wire
- Lamp dimension: 16 1/2"L x 4 1/2"H x 8 1/16"W



LUMIÈRES D'AVERTISSEMENT À DEL RECTANGULAIRE RECTANGULAR LED WARNING LIGHTS



E-950A

- 4 3/4"L x 1 7/8"W x 1 5/8"H • 9V - 36V
4 DEL ambre - Lentille ambre
CLIGNOTEMENT QUADRUPLE
4 Amber LED - Amber lens
QUAD FLASH



E-950CA

- 4 3/4"L x 1 7/8"W x 1 5/8"H • 9V - 36V
4 DEL ambre - Lentille claire
CLIGNOTEMENT QUADRUPLE
4 Amber LED - Clear lens
QUAD FLASH



E-950CG

- 4 3/4"L x 1 7/8"W x 1 5/8"H • 9V - 36V
4 DEL vert - Lentille claire
CLIGNOTEMENT QUADRUPLE
4 Green LED - Clear lens
QUAD FLASH



LUMIÈRE D'AVERTISSEMENT À DEL COMPACTE COMPACT LED WARNING LIGHT BAR

LED



E-2110AC
30 Diodes x 1W

Base en ABS et lentilles en polycarbonate • 2 supports de montage avec fils
ABS base & Polycarbonate lens • 2 mounting brackets with lead wires

12V - 24V

9.75" L x 6.77" W x 2" H

23 SÉQUENCES DIFFÉRENTES
MONTAGE PERMANENT
23 PATTERNS
PERMANENT MOUNT MODEL

GYROPHARE LED ROTATING FLASH

LED

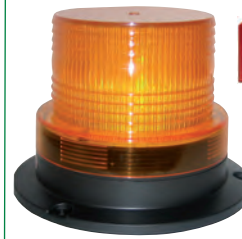

12V

4" H x 5" base dia.

E-350A
30 Diodes

Base en plastique et lentilles en polycarbonate
3 trous pour montage sur 4 5/8" de dia.
Plastic base & Polycarbonate lens
3 mounting holes on 4 5/8" dia.

LUMIÈRE D'AVERTISSEMENT À DEL LED WARNING LIGHTS

LED



12V - 30V

7 1/2" H x 8 3/4" dia.

E880AC

SERVICE EXTRÊME / HEAVY DUTY
120 Diodes, 0.87 Amps

Base en aluminium et dôme clair en plastique
Aluminum base & clear plastic dome

LUMIÈRE STROBOSCOPIQUE STROBE LIGHT



14V - 48V

4 1/2" H x 6 1/2" dia.

C450AD

3 joules, 0.3 Amps
Base en caoutchouc CLIGNOTEMENT SIMPLE
Rubber base. SINGLE FLASH

FONCTIONNANT À PILE / BATTERY OPERATED SERIES

LED



5" H x 4 3/4" dia.

E450AM
30 Diodes

Base magnétique, interrupteur "ON/OFF"
Utilise une pile 9V (non-inclus)
CLIGNOTEMENT QUADRUPLE
Magnetic base, switch ON/OFF
Use 9V battery (not included). QUAD FLASH

LED



4 1/2" H x 5" dia.

E480AM
20 Diodes

Base magnétique, interrupteur "ON/OFF"
Utilise 4 batteries AA (non-inclus)
CLIGNOTEMENT ROTATIF
Magnetic base, switch ON/OFF
Use 4 AA batteries (not included).
ROTATING FLASH

LUMIÈRE D'AVERTISSEMENT À DEL / LED WARNING LIGHT BARS

LED



16 1/2" L x 8 1/16" W x 4 3/16" H

MONTAGE PERMANENT
PERMANENT MOUNT MODEL

E-280AA
32 Diodes

LED jaune avec dôme jaune,
Clignotement quadruple avec séquence alternative gauche & droite
32 high output amber LED with amber dome & lens
Quad flash alternating left & right

LED



23" L x 3 11/16" W x 3 7/8" H
Avec supports/w/ brackets

MONTAGE PERMANENT
PERMANENT MOUNT MODEL

E-2230A
40 Diodes

40 DEL jaune
8 différentes séquences de clignotement
40 high output amber LED,
8 different flash patterns

LUMIÈRES STROBOSCOPIQUES / STROBE LIGHTS

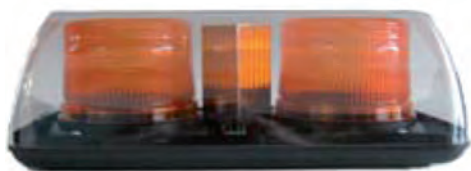

C-100A

16" L x 8 1/2" W x 6" H • 12V • 1.8 Amps draw
Base solide en ABS avec couvert et lentille en polycarbonate
Sturdy ABS base with Polycarbonate cover and lens
CLIGNOTEMENT QUADRUPLE
AVEC SÉQUENCE ALTERNATIVE
QUAD FLASH ALTERNATING SEQUENCE



C-250A

5" H x 2 3/4" base dia. • 12V - 120V.
0.24 Amps draw
CLIGNOTEMENT SIMPLE
SINGLE FLASH



C-R880A

7 3/4" H x 8 3/4" dia. • 12V • 5 Amps draw
Base en aluminium et lentille en polycarbonate
Aluminum base & Polycarbonate lens
CLIGNOTEMENT ROTATIF SIMPLE
SINGLE ROTATING FLASH

MONTAGE PERMANENT
PERMANENT MOUNT MODEL



GYROPHARES / REVOLVING LIGHTS



12 volts
SW16001
5 3/8" H x 16 1/2" L x 8 3/8"

12 volts
208R12V
Se monte sur le toit. Base incrustée
Roof mount. Stud mount
5 11/16" H x 5 7/8" dia.



MINI BARRE DE LUMIÈRES À DEL / LED MINI LIGHT BAR

AMBRE / AMBER



8 lumières DEL à haute intensité. 12V. Base en plastique ABS robuste et dôme en polycarbonate protégé des rayons UV. Adaptateur pour allume-cigarette (HEH74998011) avec interrupteur (on/off) plus interrupteur momentané qui sert à changer la configuration des clignotements
8 high intensity LED lightheads. 12V. Polycarbonate UV stabilized dome and robust ABS plastic base. Cigarette lighter plug with on/off switch (HEH74998011) plus momentary switch for flash pattern change.

HEH74998001
Fixe - Noyau à 3 câbles de 380mm. Adaptateur non inclus.
Fixed - 380mm 3 core cable. Adaptor not included.

HEH74998011
Magnétique - Cable plat de 10'
Magnetic - 10 ft flat cable

EUROLIT3

ENSEMBLE STROBOSCOPIQUE - SÉRIES PROFESSIONNELLES PROFESSIONAL SERIES - STROBE KIT



TS80050

- Alimenté par 10-30V
 - Installation des ampoules par pression
 - 6 fréquences de clignotement
 - Inclus: 4 ampoules, 2 câbles de 10' et 2 de 16 pieds pour les ampoules
 - 5.5" L X 1.75" H X 4.5" P
- Powered by 10-30V
 - Push Bulb installation
 - 6 mode Flash frequency
 - Included: 4 bulbs, two 10 foot cables and two 16 foot cables for bulbs
 - 5.5" L X 1.75" H X 4.5" D

ACCESSOIRE ACCESSORY



Vendu à l'unité
Sold per unit

TS80050AM
Ampoule stroboscopique ambre
Amber strobe bulb



ENS. DE LUMIÈRES POUR LE TOIT / RUNNING LIGHTS KITS

Ens. de 5 pcs • Blanc chromé / 5 pcs set • White chrome



IPLEDR402
DODGE
99-02 Dodge PU/Ram
Cristal clear LED

Ens. de 5 pcs / 5 pcs set



IPLEDR500S
FORD
97-03 F-150/250 LD
Platinum smoke LED



LUMIÈRES POUR LE TOIT (DEL) / LED CAB ROOF LIGHTS

CHEVROLET / GMC 07-13



PAC20-265

Ens. de 3 lumières Jaunes
Amber 3 light kit

- Donne une meilleure visibilité
- S'adapte aux toits courbés & plats
- Les cables & les connecteurs sont inclus
- Les matériaux d'instruction & d'installation sont fournis

- Provides maximum visibility
- Adapts to curved & flat roofs
- Complete wire harness with quick wire connectors
- All necessary hardware & illustrated installation instructions

15 1/2" L x 2 3/8" x 1 1/16" H
3 3/4" L x 2 3/8" x 1 1/16" H

ENS. DE LUMIÈRES POUR LE TOIT / RUNNING LIGHTS KITS

CHEVROLET 02-07 CLASSIC



3 lumières et 2 feux de gabarit
3 light cluster & 2 clearance lights

Lumières "Cluster" / Cluster light:
15 1/4" L x 5 1/16" W x 1 3/4" H
Feux de gabarit / Clearance lights:
4 11/16" L x 3 5/16" W x 1 9/16" H



PAC20-240
Ambre / Amber



PAC20-250
Clair (DEL) / Clear (LED)

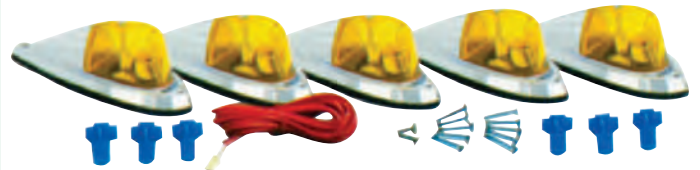

PAC20-105

Ens. inclut 5 lumières (Ambre), connecteurs, harnais et vis
Kit includes 5 amber lights, connectors, harness & screws

Ens. inclut 5 lumières jaunes, joint d'étanchéité, harnais et interrupteur pour tableau de bord avec feu de direction
Kit includes 5 amber lights, gaskets, wire harness and dash mount switch with indicator light



CHEVROLET 88-02

PAC20-220
5 7/8" L x 3 1/2" x 1 1/2" H

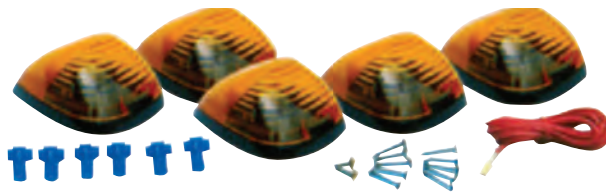

FORD 99-13

PAC20-235
4" L x 3" x 1 3/4" H

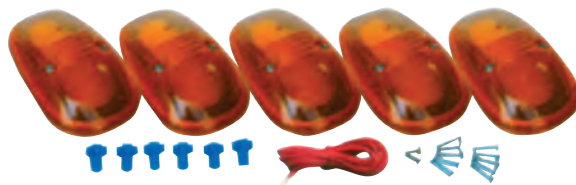
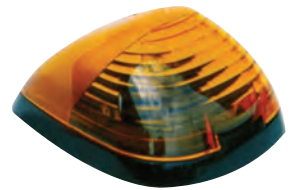

DODGE 99-02

PAC20-245
5 1/2" L x 3 1/8" x 1 3/8" H





STROMBERG CARLSON PRODUCTS INC.

PIEDS D'APPUI / PLATFORM STEPS

ALUMINIUM / ALUMINUM



PA-100

Ce pied d'appui est léger, durable et ne rouille pas. Supporte jusqu'à 1000 lb.
The platform step is lightweight, durable and will not rust. Supports up to 1000 lb.
19"W x 14"D x 3" ou/or 8" H

ACIER / STEEL



S-150

Fait d'acier de qualité et un revêtement poudré pour résister à la rouille. Supporte jusqu'à 500 lb.
Made with hi-grade steel and a powder coat finish to resist rust. Supports up to 500 lb.
24"W x 16"D x 4" ou/or 8" H

PLASTIQUE / PLASTIC



P-102

Supporte jusqu'à 500 lb.
Supports up to 500 lb
24"W x 16"D x 4" ou/or 8" H

MARCHES MANUELLES POUR VR MANUAL RV STEPS



SM-24-10
24"W x 8"D
7" baisse/drop



SM-24-20
24"W x 8"D
7" baisse/drop

SUPPORT À PNEU UNIVERSAL UNIVERSAL TIRE CARRIER

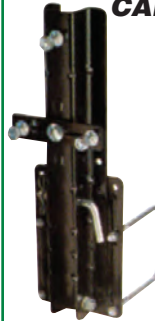

POUR PARE-CHOC
CARRÉ
FOR SQUARE
BUMPER

TR-2
Motorisé de
classe "C" et 5^e roue
Class "C" motor
home and 5th wheel

POIGNÉE D'EMBARQUEMENT POUR VR LEND-A-HAND RV RAIL



AM-200-BP
Blanche avec prise
noire en mousse
White with black
foam grip



CALES DE ROUE ONESTEP™ ONESTEP™ WHEEL CHOCKS



Se met et s'enlève en quelques secondes seulement. Pour tous les types de remorques. Fini en revêtement poudré et plaqué zinc.
Sets and removes in just seconds. For all types of trailers. Powder coat and zinc plated finish.

FY84004840
16" à/ to 24"
Paire / Pair



FY84004150
16" à/ to 30"
Unité / Unit

MIROIRS TÉLESCOPIQUES POUR REMORQUE TELESCOPIC TRAILER TOW MIRRORS

Vendu à la paire / Sold in pairs



Vous devez posséder des miroirs électriques pour utiliser le modèle électrique ci-dessous.
You must have electric mirrors to use the electric model below.

CP73700
DODGE

Ram 1500 09-13 / Ram 2500/3500 10-13
Électrique & chaleur / Electric & heat



MIROIRS DE REPÈRE / SPOT MIRRORS

Vendu à l'unité / Sold per unit



PRI300005
2 1/4" x 1 1/2"

PRI300010
2"

PRI300020
3"

PRI300030
3 3/4"

PRI300050
3 1/4" x 3 1/4"

MIROIRS DE REMORQUAGE À CLIQUET UNIVERSELS UNIVERSAL RATCHET TOW MIRRORS

Vendu à l'unité / Sold per unit



PRI300083
Fait sur le côté
droit ou gauche
Fits right
or left side

XLR